

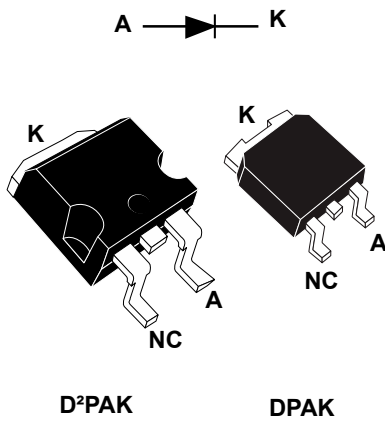

Automotive 600 V, 5 A ultrafast diode



Features

- AEC-Q101 qualified 
- Ultrafast switching
- Low reverse recovery current
- Reduces switching losses
- Low thermal resistance
- ECOPACK compliant

Applications

- Switching diode
- Free-wheeling diode
- Automotive DC/DC converter

Description

This 5A, 600 V ultrafast diode is specially suited as a boost diode in continuous mode power factor correction and hard switching conditions.

This STTH5R06-Y is also intended for use as a free wheeling diode in power supplies and other power switching applications.

Product status links

[STTH5R06-Y](#)

Product summary

$I_{F(AV)}$	5 A
V_{RRM}	600 V
$T_{j(max.)}$	175 °C
$V_{F(typ.)}$	1.5 V
$T_{rr(max.)}$	35 ns

1 Characteristics

Table 1. Absolute ratings (limiting values, at 25 °C, unless otherwise specified)

Symbol	Parameter		Value	Unit
V_{RRM}	Repetitive peak reverse voltage	T_j from -40 °C to 175 °C	600	V
$I_{F(RMS)}$	Forward rms current	D ² PAK	25	A
		DPAK	10	
$I_{F(AV)}$	Average forward current, $\delta = 0.5$, square wave	D ² PAK, DPAK $T_C = 145$ °C	5	A
I_{FSM}	Surge non repetitive forward current	D ² PAK	70	A
		DPAK	50	
T_{stg}	Storage temperature range		-65 to +175	°C
T_j	Operating junction temperature range		-40 to +175	°C

For more information, please refer to the following application note :

- AN5088 : Rectifiers thermal management, handling and mounting recommendations

Table 2. Thermal parameters

Symbol	Parameter		Maximum value	Unit
$R_{th(j-c)}$	Junction to case	Per diode	2.2	°C/W

Table 3. Static electrical characteristics

Symbol	Parameter	Test conditions		Min.	Typ.	Max.	Unit
$I_R^{(1)}$	Reverse leakage current	$T_j = 25$ °C	$V_R = V_{RRM}$	-		30	μ A
		$T_j = 125$ °C		-	30	300	
$V_F^{(2)}$	Forward voltage drop	$T_j = 25$ °C	$I_F = 5$ A	-		3.20	V
		$T_j = 125$ °C		-	1.50	1.95	

1. Pulse test: $t_p = 5$ ms, $\delta < 2\%$

2. Pulse test: $t_p = 380$ μ s, $\delta < 2\%$

To evaluate the conduction losses, use the following equation:

$$P = 1.35 \times I_{F(AV)} + 0.12 \times I_F^2 (RMS)$$

Table 4. Dynamic electrical characteristics

Symbol	Parameter	Test conditions		Min.	Typ.	Max.	Unit
t_{rr}	Reverse recovery time	$T_j = 25\text{ °C}$	$I_F = 0.5\text{ A}, I_{rr} = 0.25\text{ A}, I_R = 1\text{ A}$	-		20	ns
			$I_F = 1\text{ A}, V_R = 30\text{ V}, dI_F/dt = -50\text{ A}/\mu\text{s}$	-		35	
I_{RM}	Reverse recovery current	$T_j = 125\text{ °C}$	$I_F = 5\text{ A}, V_R = 400\text{ V}, dI_F/dt = -200\text{ A}/\mu\text{s}$	-	4.5	6	A
S_{factor}	Softness factor			-	0.5		-
Q_{rr}	Reverse recovery charge			-	110		nC
t_{fr}	Forward recovery time	$T_j = 25\text{ °C}$	$I_F = 5\text{ A}, V_{FR} = 2.5\text{ V}, dI_F/dt = 40\text{ A}/\mu\text{s}$			220	ns
V_{FP}	Forward recovery voltage					4.5	V

For more information, please refer to the following application notes related to the power losses:

- AN604: Calculation of conduction losses in a power rectifier
- AN5028: Calculation of turn-off power losses generated by an ultrafast diode

1.1 Characteristics (curves)

Figure 1. Average forward power dissipation versus average forward current

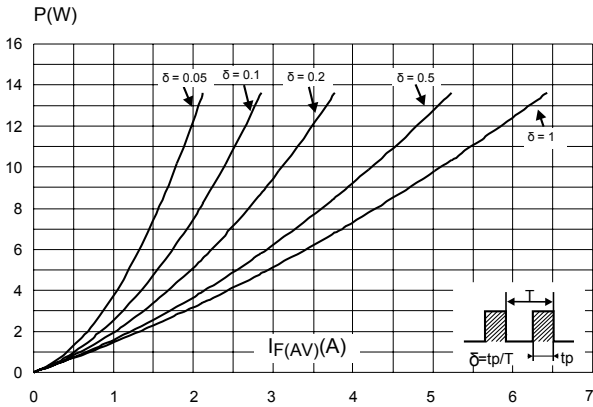

Figure 2. Forward voltage drop versus forward current

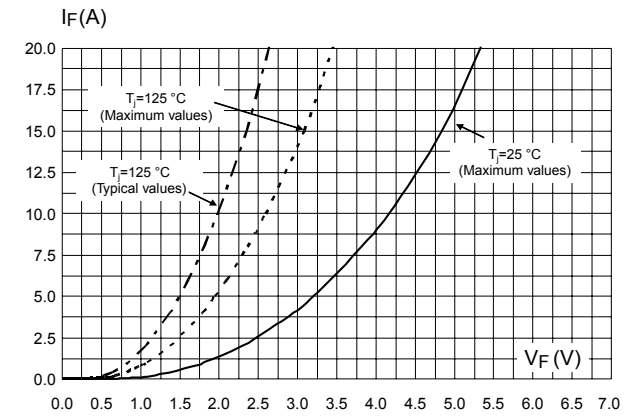

Figure 3. Relative variation of thermal impedance junction to case versus pulse duration

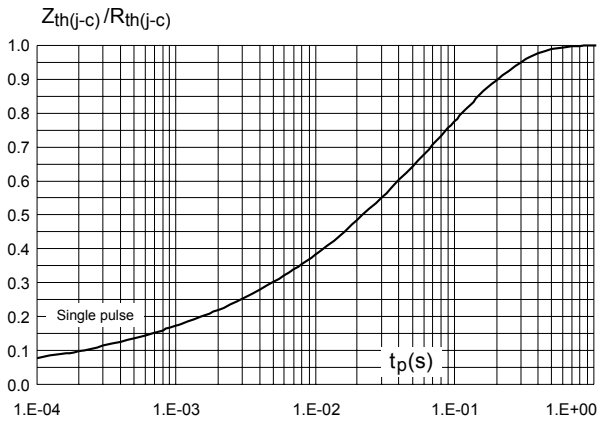

Figure 4. Peak reverse recovery current versus di_F/dt (typical values)

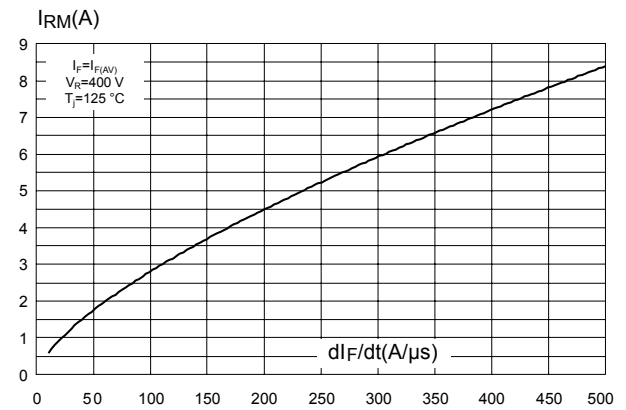

Figure 5. Reverse recovery time versus di_F/dt (typical values)

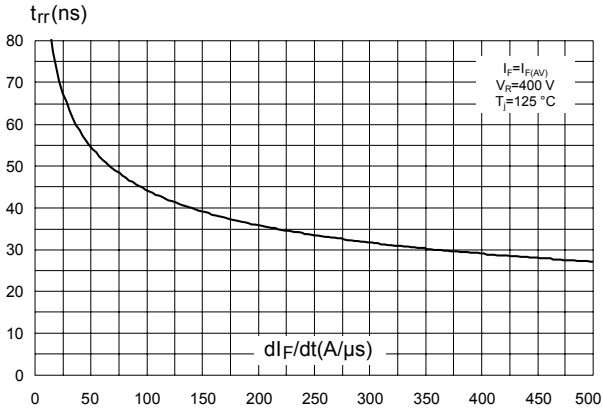

Figure 6. Reverse recovery charges versus di_F/dt (typical values)

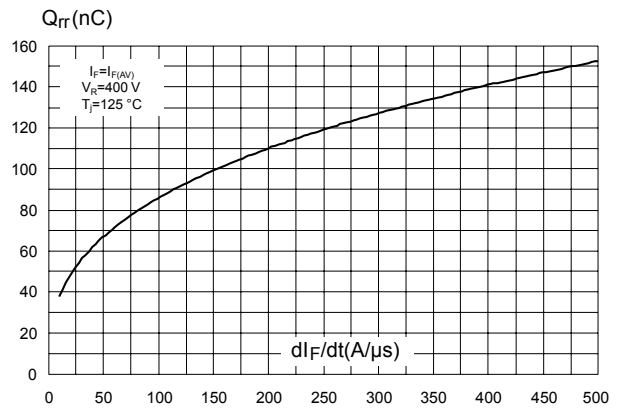

Figure 7. Softness factor versus di_F/dt (typical values)

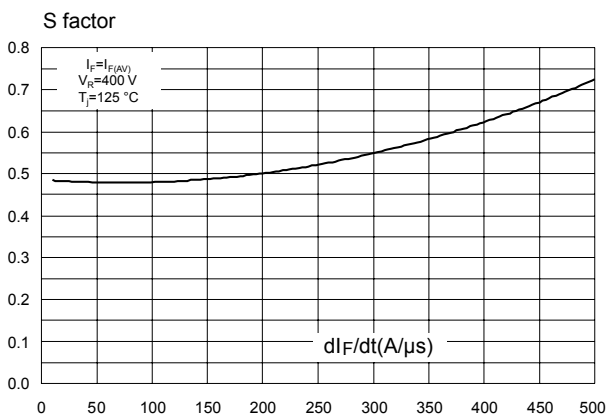

Figure 8. Relative variations of dynamic parameters versus junction temperature

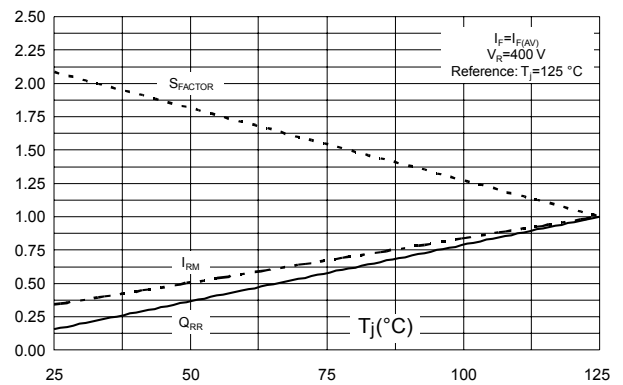

Figure 9. Transient peak forward voltage versus di_F/dt (typical values)

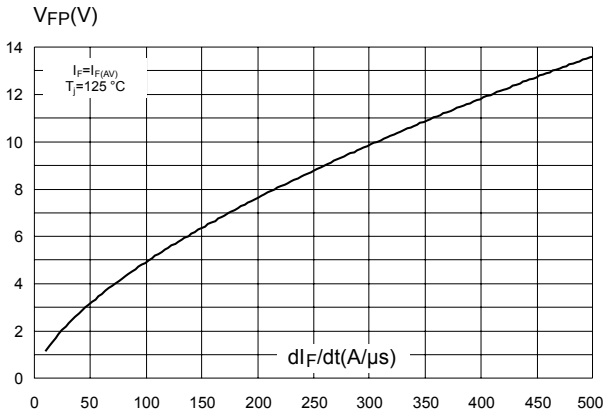

Figure 10. Forward recovery time versus di_F/dt (typical values)

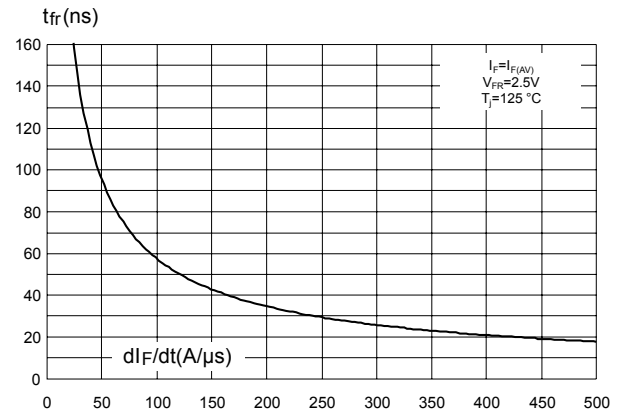

Figure 11. Junction capacitance versus reverse voltage applied (typical values, per diode)

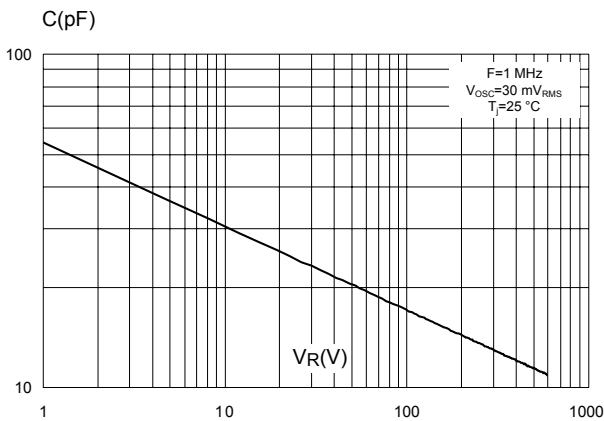

Figure 12. Thermal resistance junction to ambient versus copper surface under tab (typical values)

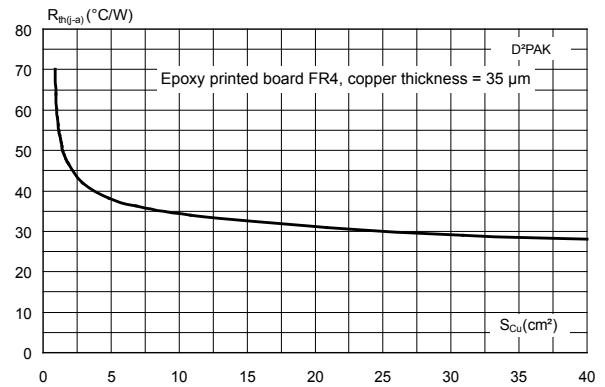
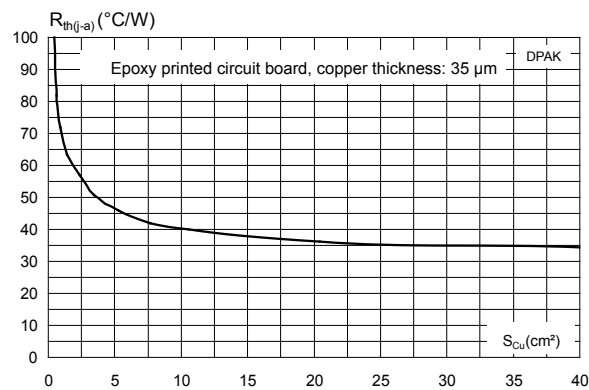

Figure 13. Thermal resistance junction to ambient versus copper surface under tab (typical values)



2 Package information

In order to meet environmental requirements, ST offers these devices in different grades of **ECOPACK** packages, depending on their level of environmental compliance. ECOPACK specifications, grade definitions and product status are available at: www.st.com. ECOPACK is an ST trademark.

2.1 D²PAK package information

- Epoxy meets UL94, V0.
- Cooling method: by conduction (C)

Figure 14. D²PAK package outline

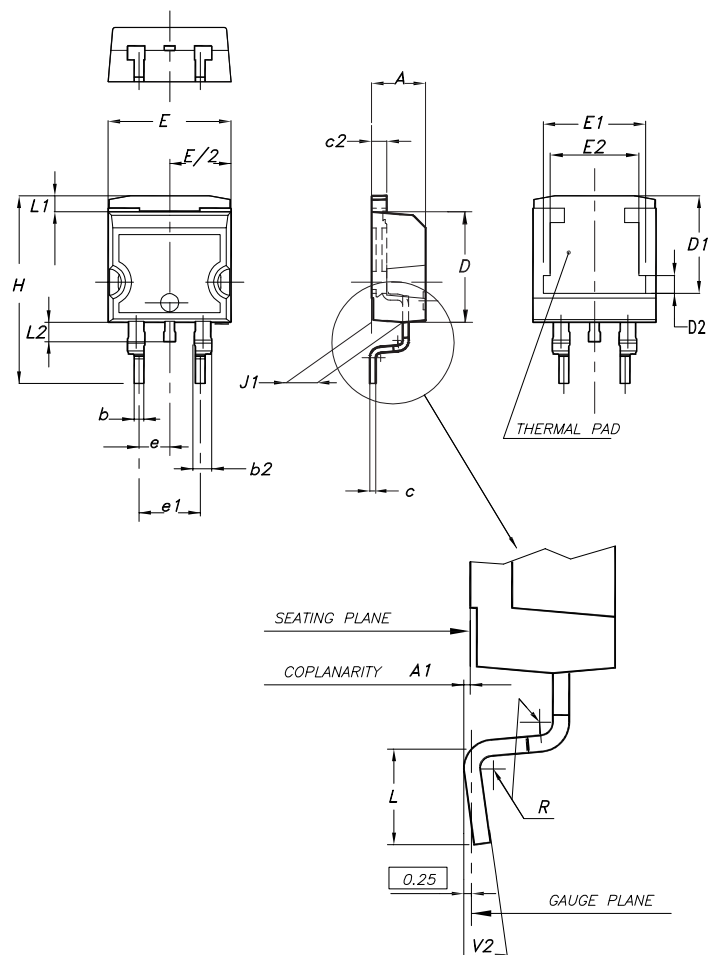

Note: This package drawing may slightly differ from the physical package. However, all the specified dimensions are guaranteed.

Table 5. D²PAK package mechanical data

Ref.	Dimensions					
	Millimeters			Inches (for reference only)		
	Min.	Typ.	Max.	Min.	Typ.	Max.
A	4.40		4.60	0.173		0.181
A1	0.03		0.23	0.001		0.009
b	0.70		0.93	0.028		0.037
b2	1.14		1.70	0.045		0.067
c	0.45		0.60	0.018		0.024
c2	1.23		1.36	0.048		0.053
D	8.95		9.35	0.352		0.368
D1	7.50	7.75	8.00	0.295	0.305	0.315
D2	1.10	1.30	1.50	0.043	0.051	0.060
E	10.00		10.40	0.394		0.409
E1	8.30	8.50	8.70	0.335	0.343	0.346
E2	6.85	7.05	7.25	0.266	0.278	0.282
e		2.54			0.100	
e1	4.88		5.28	0.190		0.205
H	15.00		15.85	0.591		0.624
J1	2.49		2.69	0.097		0.106
L	2.29		2.79	0.090		0.110
L1	1.27		1.40	0.049		0.055
L2	1.30		1.75	0.050		0.069
R		0.40			0.015	
V2	0°		8°	0°		8°

Figure 15. D²PAK recommended footprint (dimensions are in mm)

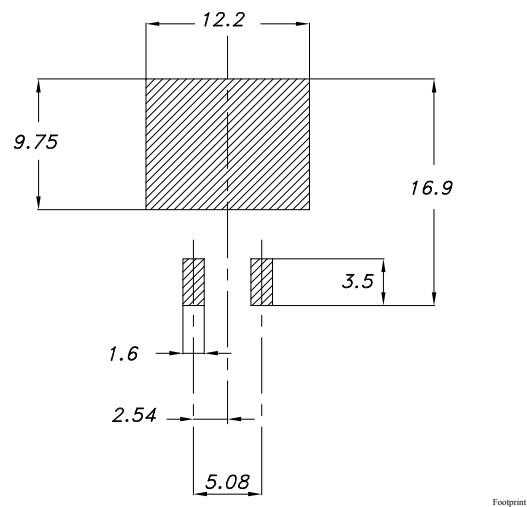
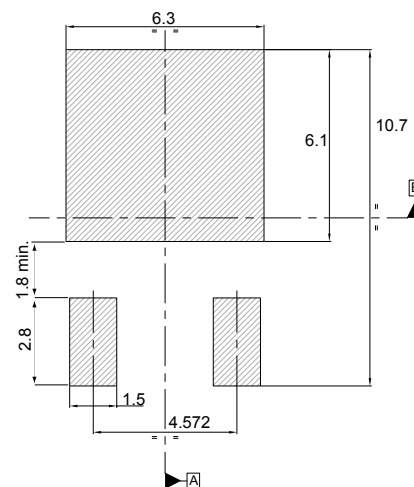

Table 6. DPAK mechanical data

Dim.	Dimensions					
	Millimeters			Inches ⁽¹⁾		
	Min.	Typ.	Max.	Min.	Typ.	Max.
A	2.20		2.40	0.087		0.094
A1	0.90		1.10	0.035		0.043
A2	0.03		0.23	0.001		0.009
b	0.64		0.90	0.025		0.035
b4	5.20		5.40	0.205		0.213
c	0.45		0.60	0.018		0.024
c2	0.48		0.60	0.019		0.024
D	6.00		6.20	0.236		0.244
D1	4.95	5.10	5.25	0.195	0.201	0.207
E	6.40		6.60	0.252		0.260
E1	4.60	4.70	4.80	0.181	0.185	0.189
e	2.159	2.286	2.413	0.085	0.090	0.095
e1	4.445	4.572	4.699	0.175	0.180	0.185
H	9.35		10.10	0.368		0.398
L	1.00		1.50	0.039		0.059
(L1)	2.60	2.80	3.00	0.102	0.110	0.118
L2	0.65	0.80	0.95	0.026	0.031	0.037
L4	0.60		1.00	0.024		0.039
R		0.20			0.008	
V2	0°		8°	0°		8°

1. Inches dimensions given for reference only

Figure 17. DPAK recommended footprint (dimensions are in mm)

The device must be positioned within $\Phi 0.05 \text{ A B}$

3 Ordering information

Table 7. Order code

Order code	Marking	Package	Weight	Base qty.	Delivery mode
STTH5R06GY-TR	STTH5R06GY	D ² PAK	1.48 g	1000	Tape and reel
STTH5R06BY-TR	STTH5R06BY	DPAK	0.35 g	2500	Tape and reel

Revision history

Table 8. Document revision history

Date	Revision	Changes
03-Nov-2011	1	First issue.
18-Mar-2019	2	Added Section Applications . Updated Table 7 . Order code.

IMPORTANT NOTICE – PLEASE READ CAREFULLY

STMicroelectronics NV and its subsidiaries (“ST”) reserve the right to make changes, corrections, enhancements, modifications, and improvements to ST products and/or to this document at any time without notice. Purchasers should obtain the latest relevant information on ST products before placing orders. ST products are sold pursuant to ST’s terms and conditions of sale in place at the time of order acknowledgement.

Purchasers are solely responsible for the choice, selection, and use of ST products and ST assumes no liability for application assistance or the design of Purchasers’ products.

No license, express or implied, to any intellectual property right is granted by ST herein.

Resale of ST products with provisions different from the information set forth herein shall void any warranty granted by ST for such product.

ST and the ST logo are trademarks of ST. For additional information about ST trademarks, please refer to www.st.com/trademarks. All other product or service names are the property of their respective owners.

Information in this document supersedes and replaces information previously supplied in any prior versions of this document.

© 2019 STMicroelectronics – All rights reserved