

**Polar3™ HiPerFET™**  
**Power MOSFET**

**IXFK64N60P3**  
**IXFX64N60P3**

$V_{DSS} = 600V$   
 $I_{D25} = 64A$   
 $R_{DS(on)} \leq 100m\Omega$   
 $t_{rr} \leq 250ns$

N-Channel Enhancement Mode  
Avalanche Rated  
Fast Intrinsic Diode



| Symbol        | Test Conditions  | Maximum Ratings  |            |
|---------------|--|------------------|------------|
| $V_{DSS}$     | $T_J = 25^\circ C$ to $150^\circ C$                                | 600              | V          |
| $V_{DGR}$     | $T_J = 25^\circ C$ to $150^\circ C$ , $R_{GS} = 1M\Omega$          | 600              | V          |
| $V_{GSS}$     | Continuous   | $\pm 30$         | V          |
| $V_{GSM}$     | Transient  | $\pm 40$         | V          |
| $I_{D25}$     | $T_C = 25^\circ C$   | 64               | A          |
| $I_{DM}$      | $T_C = 25^\circ C$ , Pulse Width Limited by $T_{JM}$               | 160              | A          |
| $I_A$         | $T_C = 25^\circ C$   | 32               | A          |
| $E_{AS}$      | $T_C = 25^\circ C$   | 1.5              | J          |
| $P_D$         | $T_C = 25^\circ C$   | 1130             | W          |
| $dv/dt$       | $I_S \leq I_{DM}$ , $V_{DD} \leq V_{DSS}$ , $T_J \leq 150^\circ C$ | 35               | V/ns       |
| $T_J$         |  | -55 ... +150     | $^\circ C$ |
| $T_{JM}$      |  | 150              | $^\circ C$ |
| $T_{stg}$     |  | -55 ... +150     | $^\circ C$ |
| $T_L$         | Maximum Lead Temperature for Soldering                             | 300              | $^\circ C$ |
| $T_{SOLD}$    | Plastic Body for 10s   | 260              | $^\circ C$ |
| $M_d$         | Mounting Torque (TO-264)   | 1.13/10          | Nm/lb.in   |
| $F_c$         | Mounting Force (PLUS247)   | 20..120 /4.5..27 | N/lb       |
| <b>Weight</b> | TO-264   | 10               | g          |
|               | PLUS247  | 6                | g          |

TO-264 (IXFK)

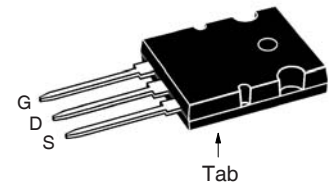

PLUS247 (IXFX)

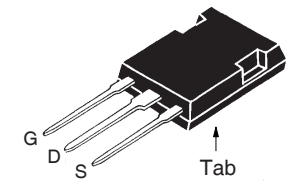

G = Gate      D = Drain  
S = Source      Tab = Drain

**Features**

- Dynamic dv/dt Rating
- Avalanche Rated
- Fast Intrinsic Diode
- Low  $Q_G$
- Low  $R_{DS(on)}$
- Low Drain-to-Tab Capacitance
- Low Package Inductance

**Advantages**

- Easy to Mount
- Space Savings

**Applications**

- DC-DC Converters
- Battery Chargers
- Switch-Mode and Resonant-Mode Power Supplies
- Uninterrupted Power Supplies
- AC Motor Drives
- High Speed Power Switching Applications

| Symbol       | Test Conditions<br>( $T_J = 25^\circ C$ Unless Otherwise Specified) | Characteristic Values |      |                    |
|--------------|---|-----------------------|------|--------------------|
|              |   | Min.                  | Typ. | Max.               |
| $BV_{DSS}$   | $V_{GS} = 0V$ , $I_D = 1mA$   | 600                   |      | V                  |
| $V_{GS(th)}$ | $V_{DS} = V_{GS}$ , $I_D = 4mA$                                     | 3.0                   |      | 5.0 V              |
| $I_{GSS}$    | $V_{GS} = \pm 30V$ , $V_{DS} = 0V$                                  |                       |      | $\pm 200$ nA       |
| $I_{DSS}$    | $V_{DS} = V_{DSS}$ , $V_{GS} = 0V$<br>$T_J = 125^\circ C$           |                       |      | 25 $\mu A$<br>3 mA |
| $R_{DS(on)}$ | $V_{GS} = 10V$ , $I_D = 0.5 \cdot I_{D25}$ , Note 1                 |                       |      | 100 m $\Omega$     |

| Symbol       | Test Conditions   | Characteristic Values |      |               |
|--------------|---|-----------------------|------|---------------|
|              |   | Min.                  | Typ. | Max.          |
| $g_{fs}$     | $V_{DS} = 10V, I_D = 0.5 \cdot I_{D25}$ , Note 1  | 36                    | 60   | S             |
| $C_{iss}$    | $V_{GS} = 0V, V_{DS} = 25V, f = 1MHz$   |                       | 9.9  | nF            |
| $C_{oss}$    |   |                       | 920  | pF            |
| $C_{rss}$    |   |                       | 4.0  | pF            |
| $R_{Gi}$     | Gate Input Resistance   |                       | 1.1  | $\Omega$      |
| $t_{d(on)}$  | <b>Resistive Switching Times</b><br>$V_{GS} = 10V, V_{DS} = 0.5 \cdot V_{DSS}, I_D = 0.5 \cdot I_{D25}$<br>$R_G = 1\Omega$ (External) |                       | 43   | ns            |
| $t_r$        |   |                       | 17   | ns            |
| $t_{d(off)}$ |   |                       | 66   | ns            |
| $t_f$        |   |                       | 11   | ns            |
| $Q_{g(on)}$  | $V_{GS} = 10V, V_{DS} = 0.5 \cdot V_{DSS}, I_D = 0.5 \cdot I_{D25}$   |                       | 145  | nC            |
| $Q_{gs}$     |   |                       | 44   | nC            |
| $Q_{gd}$     |   |                       | 35   | nC            |
| $R_{thJC}$   |   |                       | 0.11 | $^{\circ}C/W$ |
| $R_{thCS}$   |   | 0.15                  |      | $^{\circ}C/W$ |

### Source-Drain Diode

| Symbol   | Test Conditions                             | Characteristic Values |      |        |
|----------|---|-----------------------|------|--------|
|          |   | Min.                  | Typ. | Max.   |
| $I_S$    | $V_{GS} = 0V$                               |                       |      | 64 A   |
| $I_{SM}$ | Repetitive, Pulse Width Limited by $T_{JM}$ |                       |      | 260 A  |
| $V_{SD}$ | $I_F = I_S, V_{GS} = 0V$ , Note 1           |                       |      | 1.5 V  |
| $t_{rr}$ | $I_F = 32A, -di/dt = 100A/\mu s$            |                       |      | 250 ns |
| $Q_{RM}$ |   |                       | 1.2  |        |
| $I_{RM}$ | $V_R = 100V, V_{GS} = 0V$                   |                       | 12.6 | A      |

Note 1. Pulse test,  $t \leq 300\mu s$ , duty cycle,  $d \leq 2\%$ .

IXYS Reserves the Right to Change Limits, Test Conditions, and Dimensions.

IXYS MOSFETs and IGBTs are covered by one or more of the following U.S. patents:

|           |           |           |           |              |              |              |              |              |             |
|-----------|-----------|-----------|-----------|--------------|--------------|--------------|--------------|--------------|-------------|
| 4,835,592 | 4,931,844 | 5,049,961 | 5,237,481 | 6,162,665    | 6,404,065 B1 | 6,683,344    | 6,727,585    | 7,005,734 B2 | 7,157,338B2 |
| 4,860,072 | 5,017,508 | 5,063,307 | 5,381,025 | 6,259,123 B1 | 6,534,343    | 6,710,405 B2 | 6,759,692    | 7,063,975 B2 |             |
| 4,881,106 | 5,034,796 | 5,187,117 | 5,486,715 | 6,306,728 B1 | 6,583,505    | 6,710,463    | 6,771,478 B2 | 7,071,537    |             |

### TO-264 AA Outline

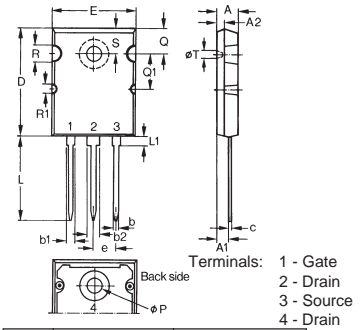

| Dim. | Millimeter |       | Inches   |       |
|------|------------|-------|----------|-------|
|      | Min.       | Max.  | Min.     | Max.  |
| A    | 4.82       | 5.13  | .190     | .202  |
| A1   | 2.54       | 2.89  | .100     | .114  |
| A2   | 2.00       | 2.10  | .079     | .083  |
| b    | 1.12       | 1.42  | .044     | .056  |
| b1   | 2.39       | 2.69  | .094     | .106  |
| b2   | 2.90       | 3.09  | .114     | .122  |
| c    | 0.53       | 0.83  | .021     | .033  |
| D    | 25.91      | 26.16 | 1.020    | 1.030 |
| E    | 19.81      | 19.96 | .780     | .786  |
| e    | 5.46 BSC   |       | .215 BSC |       |
| J    | 0.00       | 0.25  | .000     | .010  |
| K    | 0.00       | 0.25  | .000     | .010  |
| L    | 20.32      | 20.83 | .800     | .820  |
| L1   | 2.29       | 2.59  | .090     | .102  |
| P    | 3.17       | 3.66  | .125     | .144  |
| Q    | 6.07       | 6.27  | .239     | .247  |
| Q1   | 8.38       | 8.69  | .330     | .342  |
| R    | 3.81       | 4.32  | .150     | .170  |
| R1   | 1.78       | 2.29  | .070     | .090  |
| S    | 6.04       | 6.30  | .238     | .248  |
| T    | 1.57       | 1.83  | .062     | .072  |

### PLUS 247™ Outline

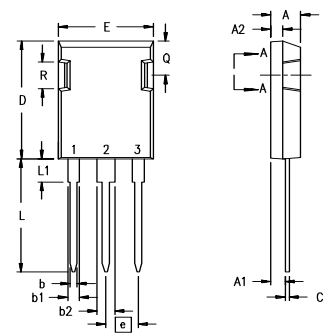

Terminals: 1 - Gate  
2 - Drain  
3 - Source

| Dim.           | Millimeter |       | Inches   |       |
|----------------|------------|-------|----------|-------|
|                | Min.       | Max.  | Min.     | Max.  |
| A              | 4.83       | 5.21  | .190     | .205  |
| A <sub>1</sub> | 2.29       | 2.54  | .090     | .100  |
| A <sub>2</sub> | 1.91       | 2.16  | .075     | .085  |
| b              | 1.14       | 1.40  | .045     | .055  |
| b <sub>1</sub> | 1.91       | 2.13  | .075     | .084  |
| b <sub>2</sub> | 2.92       | 3.12  | .115     | .123  |
| C              | 0.61       | 0.80  | .024     | .031  |
| D              | 20.80      | 21.34 | .819     | .840  |
| E              | 15.75      | 16.13 | .620     | .635  |
| e              | 5.45 BSC   |       | .215 BSC |       |
| L              | 19.81      | 20.32 | .780     | .800  |
| L1             | 3.81       | 4.32  | .150     | .170  |
| Q              | 5.59       | 6.20  | .220     | 0.244 |
| R              | 4.32       | 4.83  | .170     | .190  |

**Fig. 1. Output Characteristics @  $T_J = 25^\circ\text{C}$**

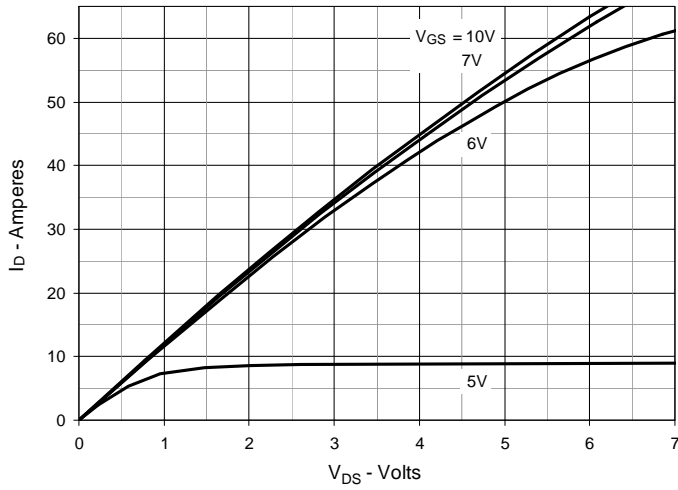

**Fig. 2. Extended Output Characteristics @  $T_J = 25^\circ\text{C}$**

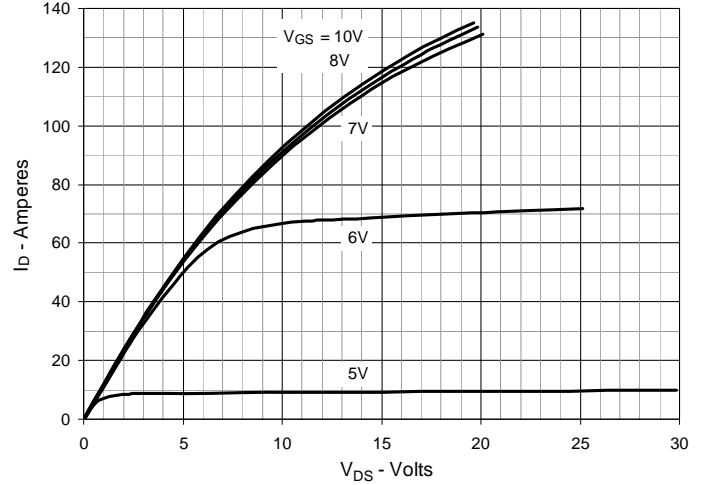

**Fig. 3. Output Characteristics @  $T_J = 125^\circ\text{C}$**

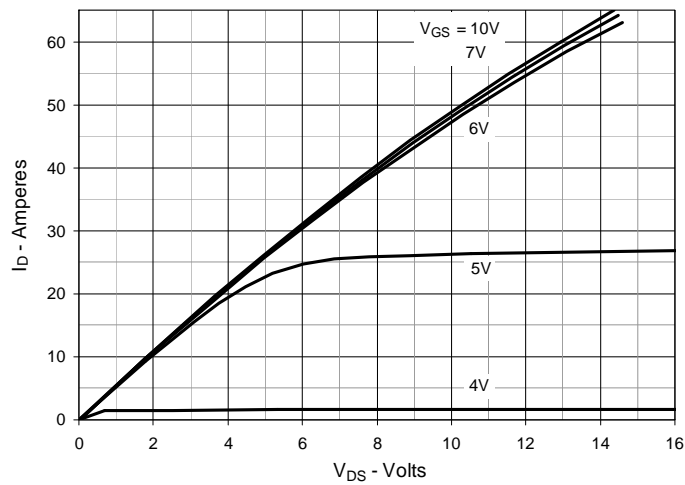

**Fig. 4.  $R_{DS(on)}$  Normalized to  $I_D = 32\text{A}$  Value vs. Junction Temperature**

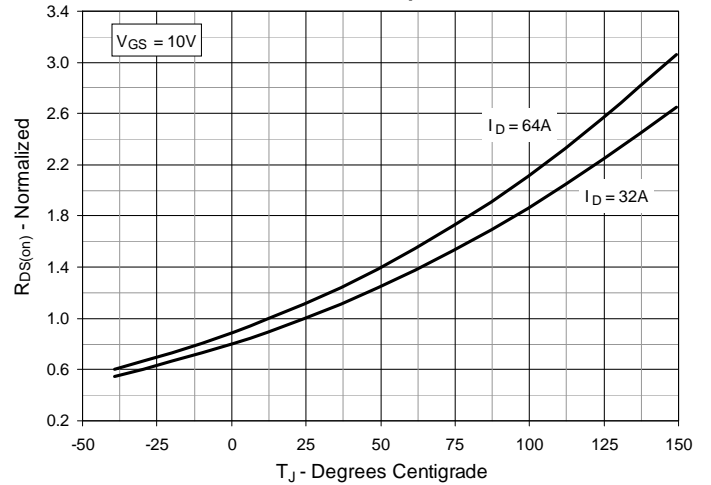

**Fig. 5.  $R_{DS(on)}$  Normalized to  $I_D = 32\text{A}$  Value vs. Drain Current**

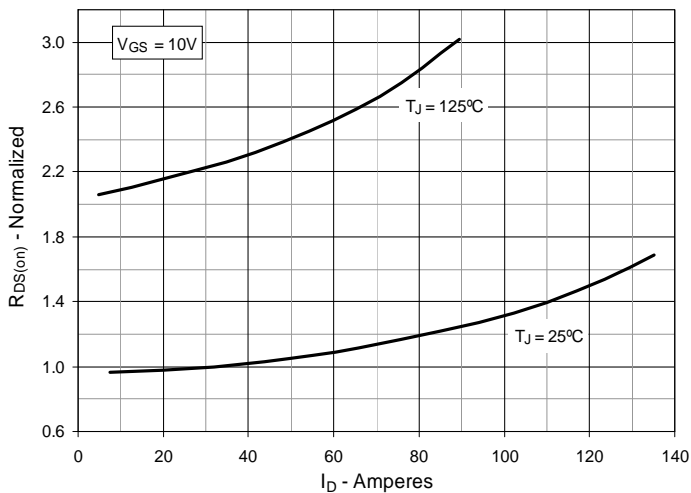

**Fig. 6. Maximum Drain Current vs. Case Temperature**

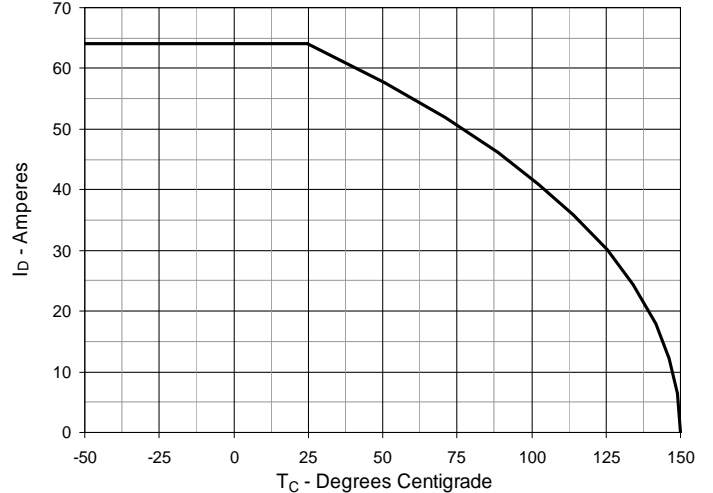

**Fig. 7. Input Admittance**

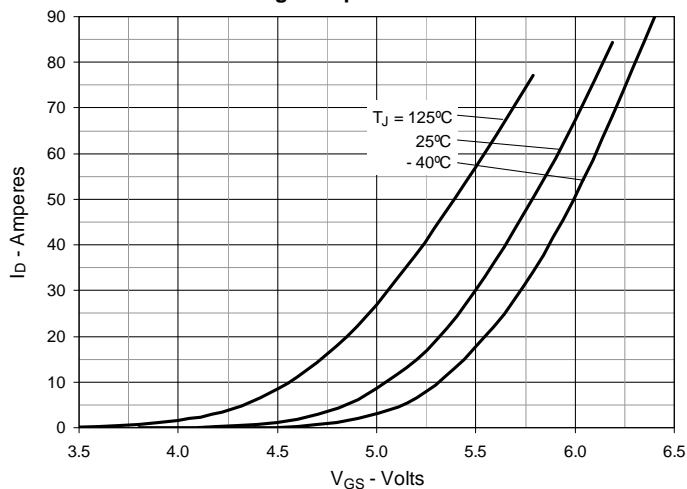

**Fig. 8. Transconductance**

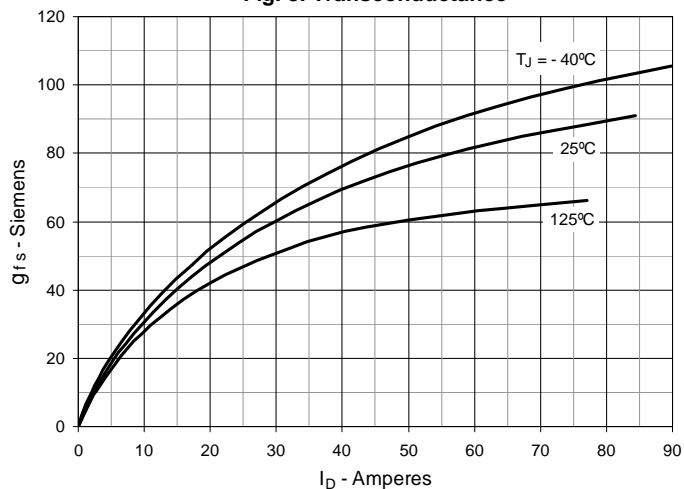

**Fig. 9. Forward Voltage Drop of Intrinsic Diode**

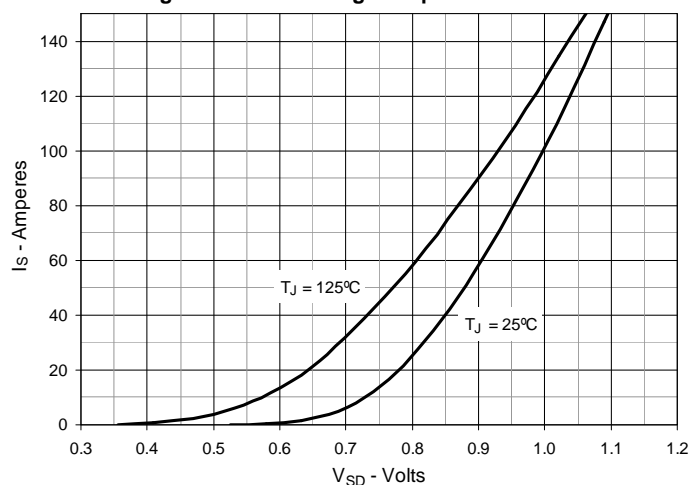

**Fig. 10. Gate Charge**

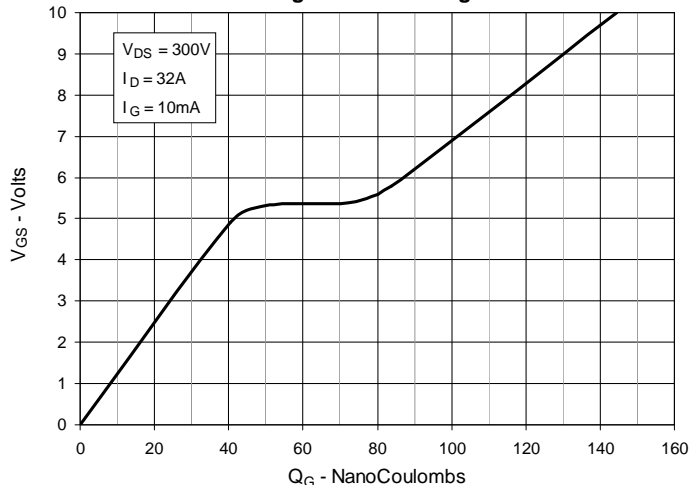

**Fig. 11. Capacitance**

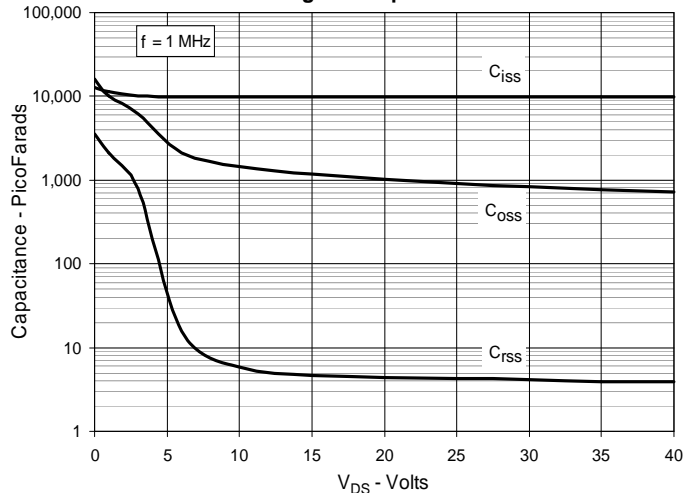

**Fig. 12. Forward-Bias Safe Operating Area**

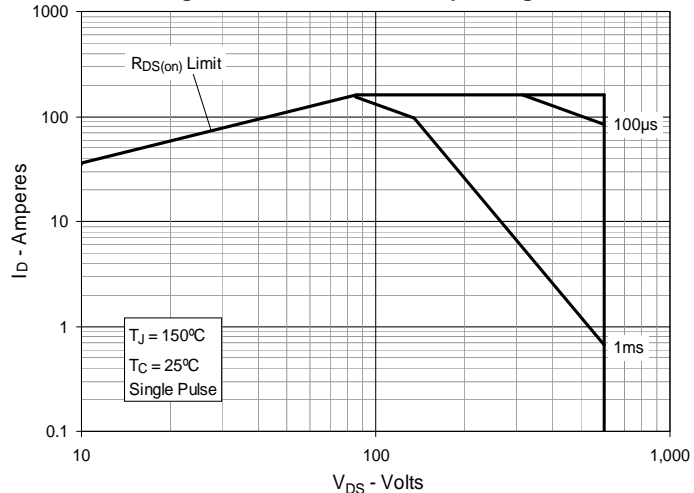
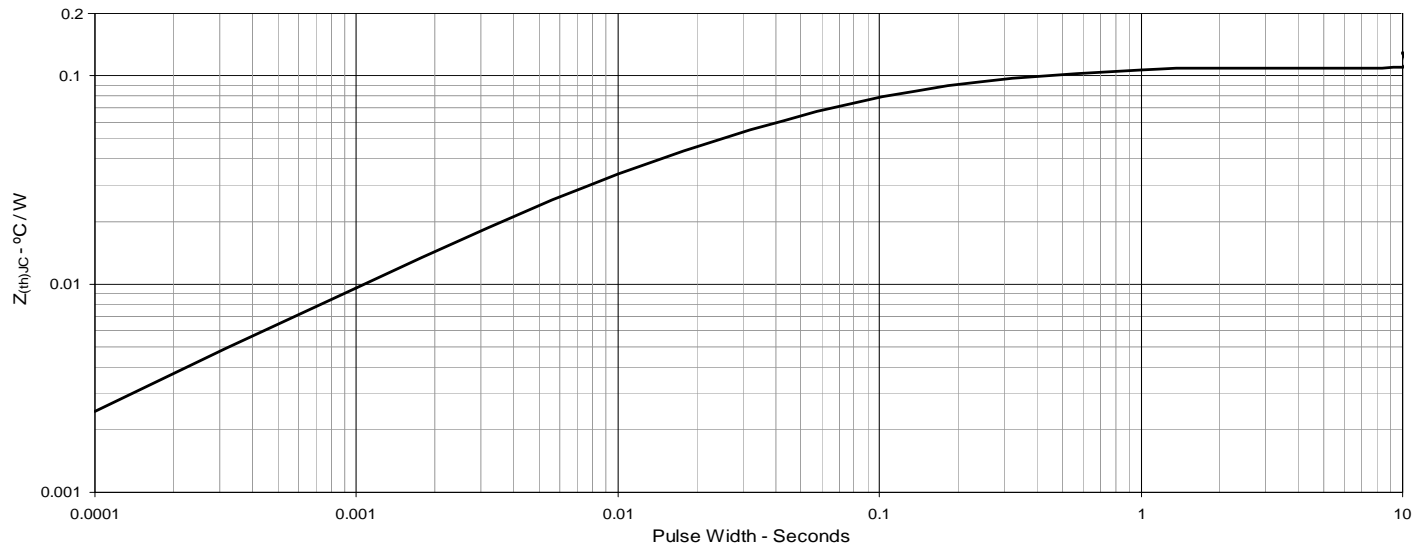

Fig. 13. Maximum Transient Thermal Impedance





---

Disclaimer Notice - Information furnished is believed to be accurate and reliable. However, users should independently evaluate the suitability of and test each product selected for their own applications. Littelfuse products are not designed for, and may not be used in, all applications. Read complete Disclaimer Notice at [www.littelfuse.com/disclaimer-electronics](http://www.littelfuse.com/disclaimer-electronics).