

AS1320

200mA Step-Up DC-DC Converter



1 General Description

The AS1320 is a high-efficiency step-up DC-DC converter designed to generate a fixed voltage of +3.3V.

The AS1320 achieves an efficiency of up to 90%. The minimum input voltage is 1.5V, the output voltage is fixed at 3.3V, and output current is up to 200mA @ 2V.

In order to save power the AS1320 features a shutdown mode, where it draws less than 1µA. In shutdown mode the battery is connected directly to the output enabling the supply of real-time-clocks.

The AS1320 provides a power-on reset output that goes high-impedance when the output reaches 90% of its regulation point.

The SHDNN trip threshold of the AS1320 can be used as an input voltage detector that disables the device when the battery voltage falls to a predetermined level.

An internal synchronous rectifier is included, thus an external transistor or Schottky diode is not required.

The AS1320 is available in a 6-pin SOT23 package.

2 Key Features

- Fixed Output Voltage: 3.3V
- Output Current: Up to 200mA @ 2V
- Internal Synchronous Rectifier
- Requires No External Schottky Diode or FETs
- Shutdown Mode Supply Current: Less Than 1µA
- Efficiency: Up to 90%
- Minimum Input Voltage: +1.5V
- Accurate Shutdown Low-Battery Cutoff Threshold
- Battery Input Connected to Pin OUT in Shutdown Mode for Backup Power
- 6-pin SOT23 Package

3 Applications

The AS1320 is ideal for low-power applications where ultra-small size is critical as in medical diagnostic equipment, hand-held instruments, pagers, digital cameras, remote wireless transmitters, cordless phones, and PC cards.

The device is also perfect as a local 3.3V supply or as a battery backup.

Figure 1. Application Diagram

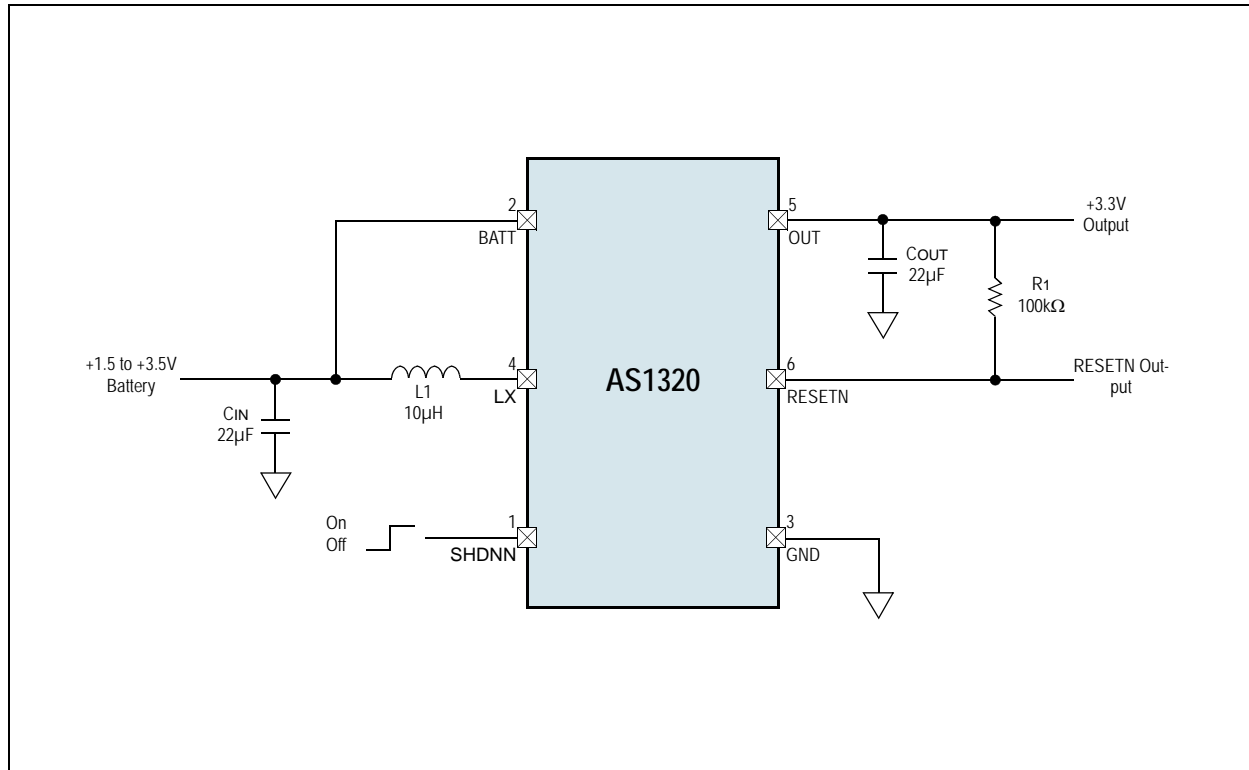

4 Pin Assignments

Figure 2. Pin Assignments (Top View)

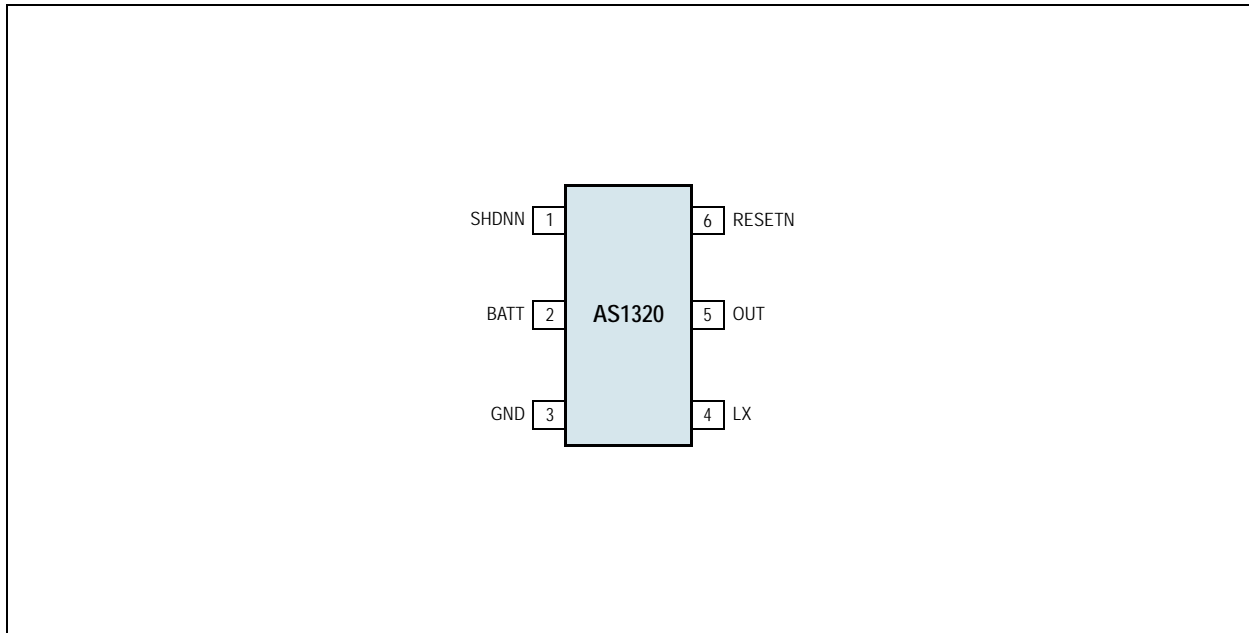

4.1 Pin Descriptions

Table 1. Pin Descriptions

Pin Number	Pin Name	Description
1	SHDNN	Active-Low Logic Shutdown Input 0 = The AS1320 is off and the current into BATT is $\leq 1\mu\text{A}$ (typ). 1 = The AS1320 is on.
2	BATT	Battery Voltage Input
3	GND	Ground
4	LX	External Inductor Connection
5	OUT	Output Voltage
6	RESETN	Active-Low reset output

5 Absolute Maximum Ratings

Stresses beyond those listed in [Table 2](#) may cause permanent damage to the device. These are stress ratings only, and functional operation of the device at these or any other conditions beyond those indicated in [Section 6 Electrical Characteristics on page 4](#) is not implied. Exposure to absolute maximum rating conditions for extended periods may affect device reliability.

Table 2. Absolute Maximum Ratings

Parameter	Min	Max	Units	Comments
All Pins to GND	-0.3	7	V	
LX Current		1	A	
Latch-Up	-100	100	mA	<i>JEDEC 78</i>
Package Power Dissipation ($T_{AMB} = +70^{\circ}\text{C}$)		500	mW	($\Theta_{JA} = 9.1\text{mW}/^{\circ}\text{C}$ above $+70^{\circ}\text{C}$)
Operating Temperature Range	-40	+85	$^{\circ}\text{C}$	
Electrostatic Discharge	-500	+500	V	<i>HBM MIL-Std. 883E 3015.7 methods</i>
Humidity (Non-Condensing)	5	85	%	
Storage Temperature Range	-55	125	$^{\circ}\text{C}$	
Junction Temperature		150	$^{\circ}\text{C}$	
Package Body Temperature		260	$^{\circ}\text{C}$	The reflow peak soldering temperature (body temperature) specified is in compliance with <i>IPC/JEDEC J-STD-020 "Moisture/Reflow Sensitivity Classification for Non-Hermetic Solid State Surface Mount Devices"</i> .

6 Electrical Characteristics

$T_{AMB} = -40$ to $+85^{\circ}\text{C}$, $V_{BATT} = +2\text{V}$, $V_{OUT} = +3.3$, $V_{SHDNN} = +1.5\text{V}$ (unless otherwise specified). Typical values @ $T_{AMB} = +25^{\circ}\text{C}$.

Table 3. Electrical Characteristics

Symbol	Parameter	Conditions	Min	Typ	Max	Unit
VBATT	Battery Input Range		1.5		3.5	V
VSU	Startup Battery Input Voltage ¹	RLOAD = 47Ω, TAMB = +25°C		1.22	1.5	V
		RLOAD = 47Ω, TAMB = -40 to +85°C		1.24		
VOUT	Output Voltage ²	TAMB = +25°C	3.267	3.300	3.333	V
		TAMB = -40 to +85°C	3.217		3.373	
RNCH	N-Channel On-Resistance	ILX = 100mA, TAMB = +25°C		0.3	1.2	Ω
		ILX = 100mA, TAMB = -40 to +85°C			1.5	
RPCH	P-Channel On-Resistance	ILX = 100mA, TAMB = +25°C		0.4	1.3	Ω
		ILX = 100mA, TAMB = -40 to +85°C			1.6	
IMAX	N-Channel Switch Current Limit ¹	TAMB = +25°C	550	700	850	mA
		TAMB = -40 to +85°C	450		950	
tON	Switch Maximum On-Time	TAMB = +25°C	5	7	9	μs
		TAMB = -40 to +85°C	4		10	
	Synchronous Rectifier Zero-Crossing Current	TAMB = +25°C	8	30	60	mA
		TAMB = -40 to +85°C	0		65	
	Quiescent Current into OUT	VOUT = +3.5V, TAMB = +25°C		35	55	μA
		VOUT = +3.5V, TAMB = -40 to +85°C			60	
	Shutdown Current into OUT	VSHDNN = 0V, TAMB = +25°C		0.01	1	μA
		VSHDNN = 0V, TAMB = -40 to +85°C			2	
	Quiescent Current into BATT	VOUT = +3.5V, TAMB = +25°C		0.01	1	μA
		VOUT = +3.5V, TAMB = -40 to +85°C			2	
	Shutdown Current into BATT	VSHDNN = 0V, TAMB = +25°C		0.01	1	μA
		VSHDNN = 0V, TAMB = -40 to +85°C			2	
	SHDNN Logic Low ¹	VBATT = +1.5 to +3.5V			0.3	V
	SHDNN Threshold	Rising Edge, TAMB = +25°C	1.185	1.228	1.271	V
		Rising Edge, TAMB = -40 to +85°C	1.170		1.286	
	SHDNN Threshold Hysteresis			0.02		V
	RESETN Threshold	Falling Edge, TAMB = +25°C	2.830	3.000	3.110	V
		Falling Edge, TAMB = -40 to +85°C	2.800		3.140	
	RESETN Voltage Low	IRESETN = 1mA, VOUT = +2.5V, TAMB = +25°C			0.15	V
		IRESETN = 1mA, VOUT = +2.5V, TAMB = -40 to +85°C			0.2	
	RESETN Leakage Current	VRESETN = +5.5V, TAMB = +25°C		0.1	100	nA
		VRESETN = +5.5V, TAMB = +85°C		1		
	LX Leakage Current	TAMB = +25°C		0.1	1000	nA
		TAMB = +85°C		10		
ILOAD	Maximum Load Current	VBATT = +2V		200		mA
η	Efficiency	VBATT = +3V, ILOAD = 100mA		90		%

1. Guaranteed by design.

2. Voltage which triggers next loading cycle. Ripple and rms value depend on external components.

Note: All limits are guaranteed. The parameters with min and max values are guaranteed with production tests or SQC (Statistical Quality Control) methods.

7 Typical Operating Characteristics

$V_{OUT} = 3.3V$, $V_{BATT} = +2V$, $T_{AMB} = +25^{\circ}C$.

Figure 3. V_{OUT} vs. V_{BATT} ; On, 16Ω

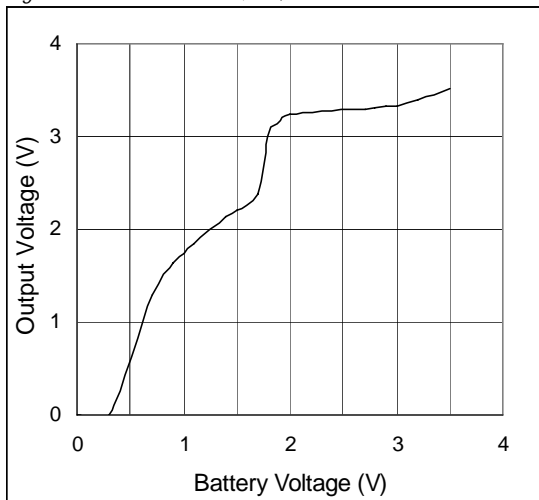

Figure 4. V_{OUT} vs. V_{BATT} ; On, 330Ω

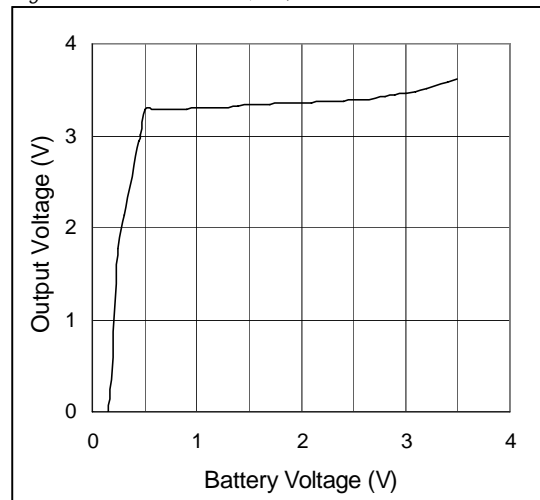

Figure 5. V_{OUT} vs. V_{BATT} ; Shutdown, $200mA$ Load

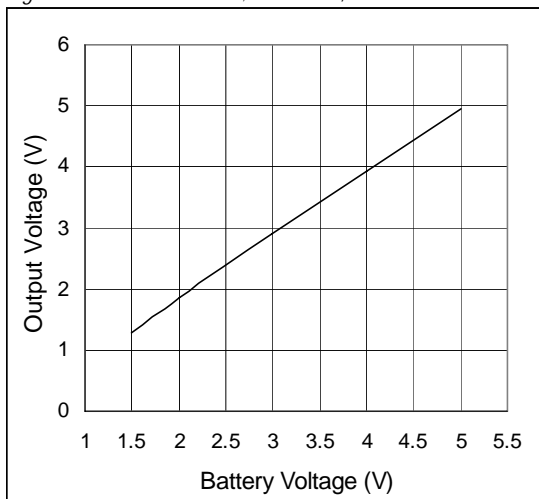

Figure 6. V_{OUT} vs. V_{BATT} ; Shutdown, No Load

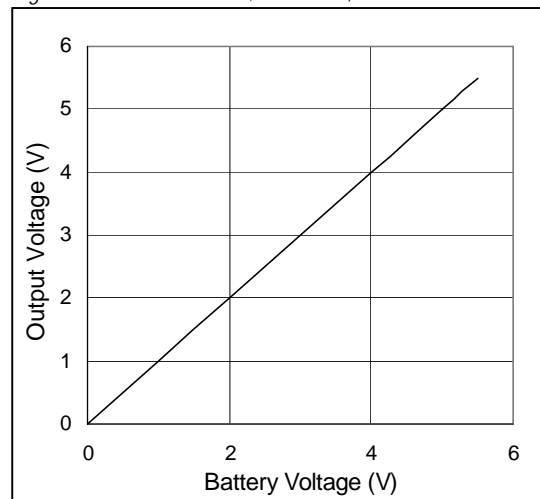

Figure 7. Maximum Output Current vs. V_{BATT}

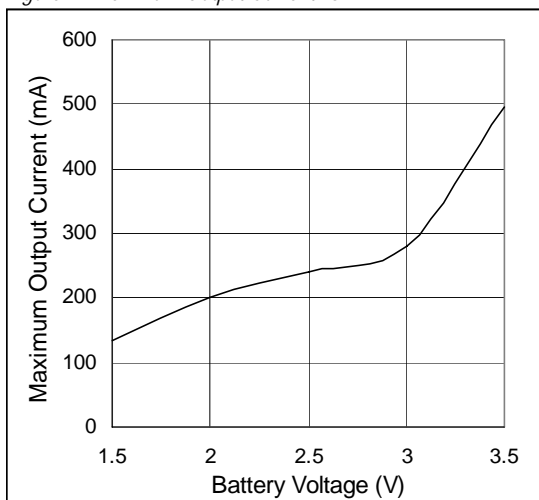

Figure 8. Startup Voltage vs. Load Resistance

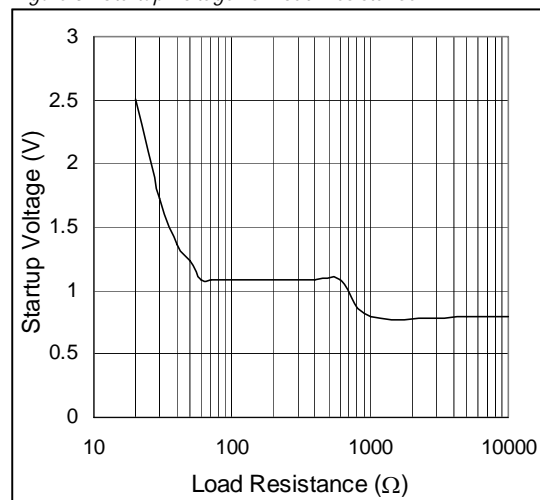

Figure 9. Line Transient

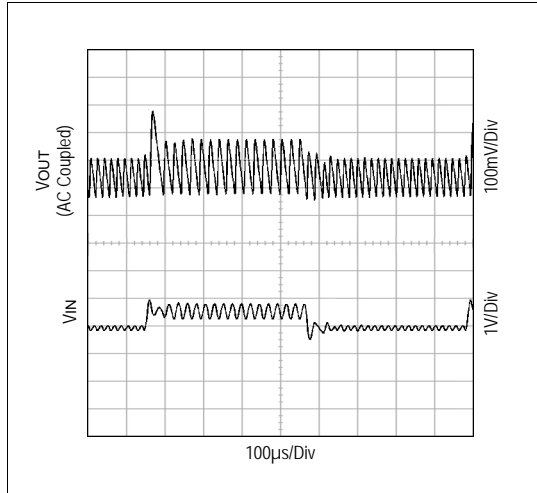

Figure 10. Load Transient

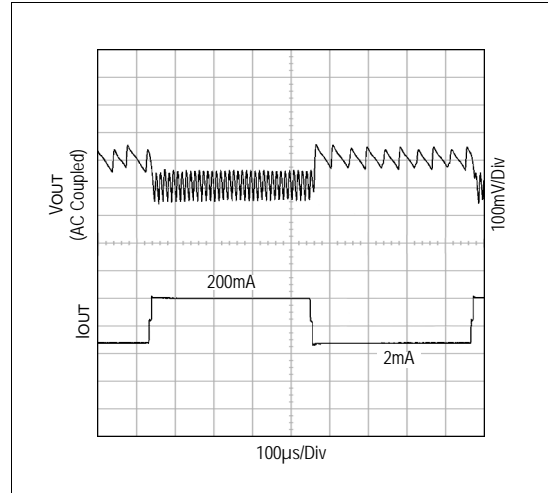

Figure 11. On/Off Response; $R_{LOAD} = 33\Omega$

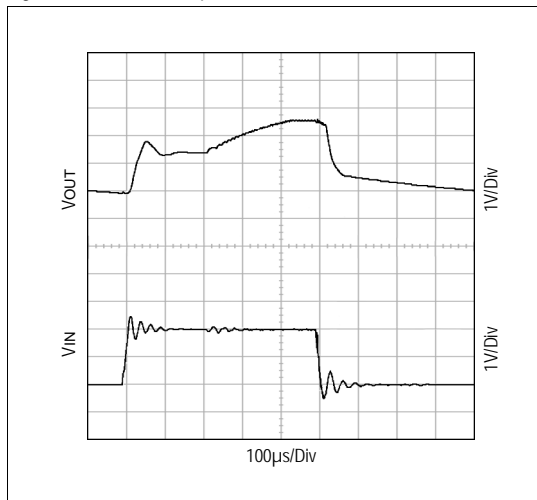

Figure 12. Shutdown Response; $R_{LOAD} = 33\Omega$

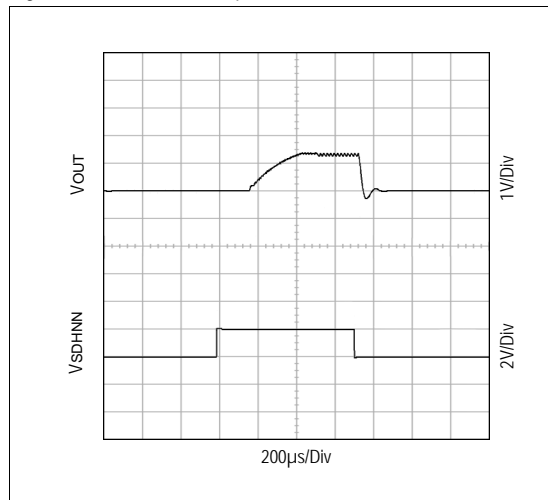

Figure 13. Switching Waveforms; $R_{LOAD} = 33\Omega$

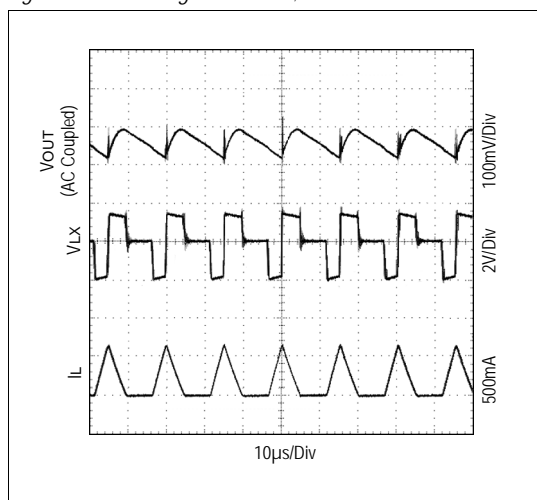
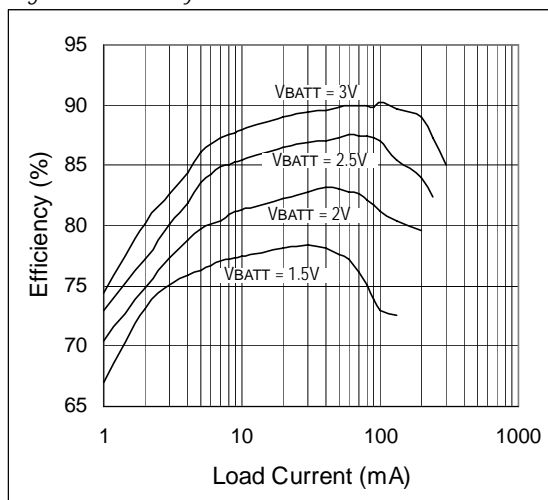

Figure 14. Efficiency vs. Load Current



8 Detailed Description

The AS1320 is a high-efficiency, compact step-up converter with 35 μ A quiescent supply current which ensures the highest efficiency over a wide load range. With a minimum of +1.5V input voltage, the device is well suited for applications with one- or two-cells, such as lithium ion (Li+), nickel-metal-hydride (NiMH), or alkaline.

Figure 15. Block Diagram

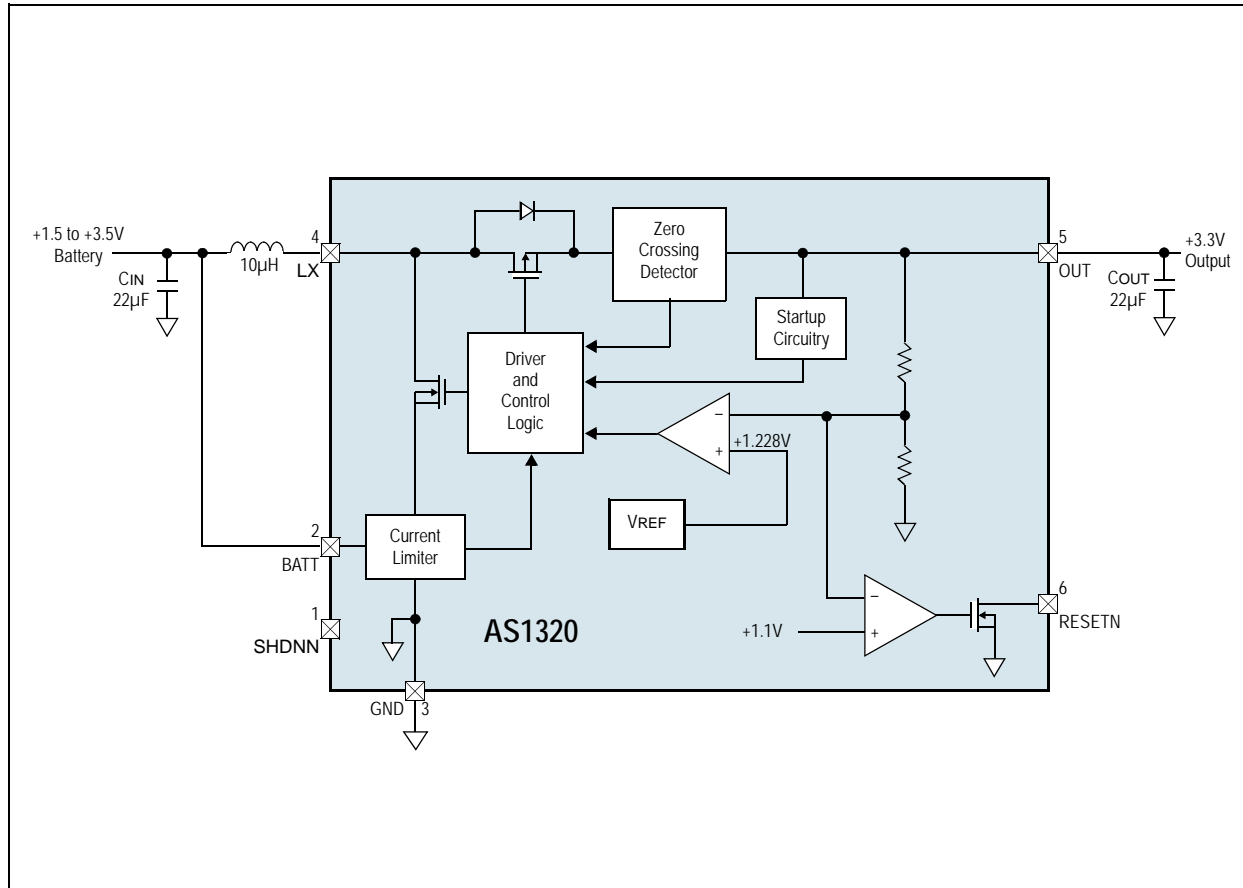

The input battery is connected to the device through an inductor and an internal P-FET when pin SHDNN is low. In this state, the step-up converter is off and the voltage drop across the P-FET body diode is eliminated, and the input battery can be used as a battery-backup or real-time-clock supply.

The built-in synchronous rectifier significantly improves efficiency and reduces PCB circuit size and costs by eliminating the need for an external Schottky diode.

8.1 Control Circuitry

The AS1320 integrated current-limited key circuitry provides low quiescent current and extremely-high efficiency over a wide VOUT range without the need for an oscillator. Inductor current is limited by the 7 μ s switch maximum on-time or by the 0.7A N-channel current limit. At each cycle, the inductor current must ramp down to zero after the on-time before the next cycle may start. When the error comparator senses that the output has fallen below the regulation threshold, another cycle begins.

An internal synchronous rectifier eliminates the need for an external Schottky diode, thereby reducing costs and PCB surface area. As the inductor discharges, the P-channel MOSFET turns on and shunts the MOSFET body diode, resulting in a significant reduction of the rectifier voltage drop, improving efficiency without external components.

8.2 Shutdown

When pin SHDNN is low the AS1320 is switched off and no current is drawn from battery; when pin SHDNN is high the device is switched on. If SHDNN is driven from a logic-level output, the logic high-level (on) should be referenced to V_{OUT} to avoid intermittently switching the device on.

Note: If pin SHDNN is not used, it should be connected directly to pin OUT.

In shutdown the battery input is connected to the output through the inductor and the internal synchronous rectifier P-FET. This allows the input battery to provide backup power for devices such as an idle microcontroller, memory, or real-time-clock, without the usual diode forward drop. In this way a separate backup battery is not needed.

In cases where there is residual voltage during shutdown, some small amount of energy will be transferred from pin OUT to pin BATT immediately after shutdown, resulting in a momentary spike of the voltage at pin BATT. The ratio of C_{IN} and C_{OUT} partly determine the size and duration of this spike, as does the current-sink ability of the input device.

8.3 Low-Battery Cutoff

The AS1320 SHDNN trip threshold (1.228V) can be used as an input voltage detector that disables the device when the battery input voltage falls to a pre-set level. An external resistor-divider network can be used to set the battery-detection voltage (see Figure 16).

Figure 16. Low-Battery Cutoff Application Diagram

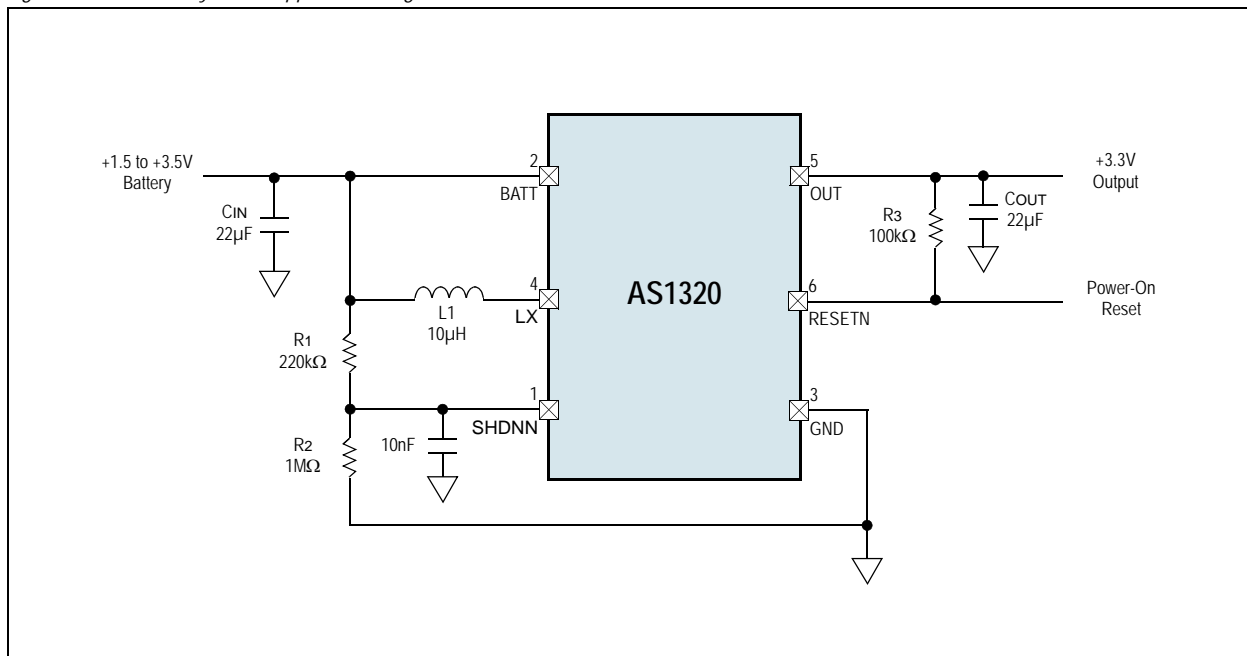

For the resistor-divider network shown in Figure 16, calculate the value for R₁ by:

$$R_1 = R_2 \times ((V_{OFF}/V_{SHDNN}) - 1) \quad (EQ 1)$$

Where:

V_{OFF} is the battery voltage at which the AS1320 shuts down.

V_{SHDNN} = 1.228V

The value of R₂ should be between 100kΩ and 1MΩ to minimize battery drain.

Note: Input ripple can cause false shutdowns, therefore to minimize the effect of ripple, a low-value capacitor from SHDNN to GND should be used to filter out input noise. The value of the capacitor should be such that the R/C time constant is > 2ms.

8.4 Power-On Reset

The AS1320 provides a power-on reset output (RESETN) that goes high-impedance when the output reaches 90% of its regulation point. RESETN goes low when the output is below 90% of the regulation point. A 100kΩ to 1MΩ pullup resistor between pin RESETN and pin OUT can provide a microprocessor logic control signal.

Note: Connect pin RESETN to GND when the power-on reset feature is not used.

9 Application Information

9.1 Inductor Selection

The control circuitry of the AS1320 permits a wide range of inductor values to be selected – from 4.7 to 47µH; 10µH is ideal for most applications.

The intended application should dictate the value of L. The trade-off between required PCB surface area and desired output ripple are the determining factors: smaller values for L require less PCB space, larger values of L reduce output ripple. If the value of L is large enough to prevent I_{MAX} from being reached before t_{ON} expires, the AS1320 output power will be reduced.

For maximum output current calculate the value for L as:

$$(V_{BATT(MAX)}(1\mu s))/0.7A < L < (V_{BATT(MIN)}(7\mu s))/0.7A \quad (EQ 2)$$

$$I_{OUT(MAX)} = [(0.7A/2)(V_{BATT(MIN)} - (0.7A/2)(R_{NCH} + R_{IND}))]/V_{OUT} \quad (EQ 3)$$

Where:

R_{IND} is the inductor series resistance.

R_{NCH} is the R_{DS(ON)} of the N-channel MOSFET (0.3Ω typ).

Note: Coils should be able to handle 500mARMS and have a I_{SAT} ≥ 1A and should have a R_{IND} ≤ 100mΩ.

9.2 Capacitor Selection

9.2.1 C_{OUT} Selection

Choose a C_{OUT} value to achieve the desired output ripple percentage. A 22µF ceramic capacitor is a good initial value. The value for C_{OUT} can be determined by:

$$C_{OUT} > (L + 2.5\mu H) \times V_{BATT(MAX)}^2 / r\% \quad (EQ 4)$$

Where:

r is the desired output ripple in %.

9.2.2 C_{IN} Selection

C_{IN} reduces the peak current drawn from the battery and can be the same value as C_{OUT}. A larger value for C_{IN} can be used to further reduce ripple and improve AS1320 efficiency.

9.3 PC Board Layout and Grounding

Well-designed printed circuit-board layout is important for minimizing ground bounce and noise.

- Place pin GND lead and the ground leads of C_{IN} and C_{OUT} as close to the device as possible.
- Keep the lead to pin LX as short as possible.
- To maximize output power and efficiency and minimize output ripple voltage, use a ground plane and solder the GND pin directly to the ground plane.

10 Package Drawings and Markings

The AS1320 is available in a 6-pin SOT23 package.

Figure 17. 6-pin SOT23 Package

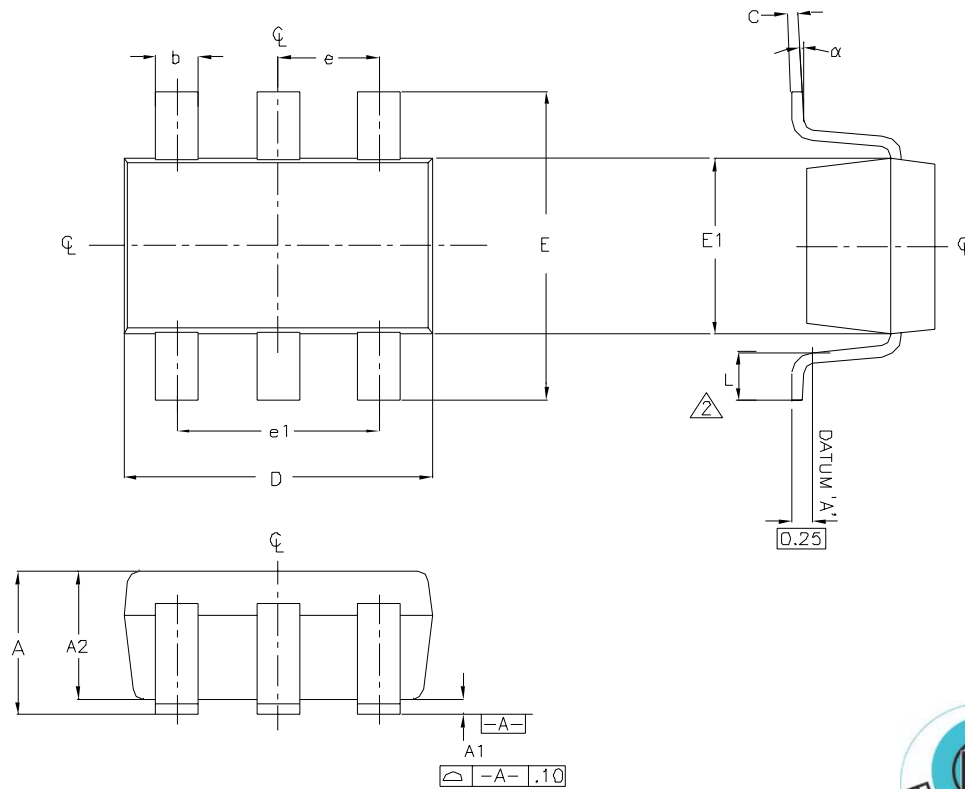

Notes:

1. All dimensions are in millimeters.
2. Foot length is measured at the intercept point between datum A and lead surface.
3. Package outline exclusive of mold flash and metal burr.
4. Pin 1 is the lower left pin when reading the top mark from left to right.
5. Pin 1 identifier dot is $0.3\text{mm} \cdot \phi$ min and is located above pin 1.
6. Meets JEDEC MO178.

Symbol	Min	Max
A	0.90	1.45
A1	0.00	0.15
A2	0.90	1.30
b	0.35	0.50
C	0.08	0.20
D	2.80	3.00
E	2.60	3.00
E1	1.50	1.75
L	0.35	0.55
e	0.95 REF	
α	0°	10°

11 Ordering Information

The AS1320 is available as the standard products shown in [Table 4](#).

Table 4. Ordering Information

Ordering Code	Marking	Description	Delivery Form	Package
AS1320-T	ASD7	200mA Step-Up DC-DC Converter	Tape and Reel	6-pin SOT23

Note: All products are RoHS compliant.

Buy our products or get free samples online at ICdirect: <http://www.austriamicrosystems.com/ICdirect>

Technical Support is found at <http://www.austriamicrosystems.com/Technical-Support>

For further information and requests, please contact us <mailto:sales@austriamicrosystems.com>
or find your local distributor at <http://www.austriamicrosystems.com/distributor>

Design the AS1320 online at <http://www.austriamicrosystems.com/analogbench>
[analogbench](#) is a powerful design and simulation support tool that operates in on-line and off-line mode to evaluate performance and generate application-specific bill-of-materials for austriamicrosystems' power management devices.



Copyrights

Copyright © 1997-2010, austriamicrosystems AG, Tobelbaderstrasse 30, 8141 Unterpremstaetten, Austria-Europe. Trademarks Registered ®. All rights reserved. The material herein may not be reproduced, adapted, merged, translated, stored, or used without the prior written consent of the copyright owner.

All products and companies mentioned are trademarks or registered trademarks of their respective companies.

Disclaimer

Devices sold by austriamicrosystems AG are covered by the warranty and patent indemnification provisions appearing in its Term of Sale. austriamicrosystems AG makes no warranty, express, statutory, implied, or by description regarding the information set forth herein or regarding the freedom of the described devices from patent infringement. austriamicrosystems AG reserves the right to change specifications and prices at any time and without notice. Therefore, prior to designing this product into a system, it is necessary to check with austriamicrosystems AG for current information. This product is intended for use in normal commercial applications. Applications requiring extended temperature range, unusual environmental requirements, or high reliability applications, such as military, medical life-support or life-sustaining equipment are specifically not recommended without additional processing by austriamicrosystems AG for each application. For shipments of less than 100 parts the manufacturing flow might show deviations from the standard production flow, such as test flow or test location.

The information furnished here by austriamicrosystems AG is believed to be correct and accurate. However, austriamicrosystems AG shall not be liable to recipient or any third party for any damages, including but not limited to personal injury, property damage, loss of profits, loss of use, interruption of business or indirect, special, incidental or consequential damages, of any kind, in connection with or arising out of the furnishing, performance or use of the technical data herein. No obligation or liability to recipient or any third party shall arise or flow out of austriamicrosystems AG rendering of technical or other services.



Contact Information

Headquarters

austriamicrosystems AG
Tobelbaderstrasse 30
A-8141 Unterpremstaetten, Austria

Tel: +43 (0) 3136 500 0
Fax: +43 (0) 3136 525 01

For Sales Offices, Distributors and Representatives, please visit:

<http://www.austriamicrosystems.com/contact>