

# TinyLogic UHS Dual Buffer with 3-STATE Outputs

## NC7WZ126

### Description

The NC7WZ126 is a Dual Non-Inverting Buffer with independent active HIGH enables for the 3-STATE outputs. The Ultra High Speed device is fabricated with advanced CMOS technology to achieve superior switching performance with high output drive while maintaining low static power dissipation over a broad  $V_{CC}$  operating range. The device is specified to operate over the 1.65 V to 5.5 V  $V_{CC}$  operating range. The inputs and outputs are high impedance when  $V_{CC}$  is 0 V. Inputs tolerate voltages up to 5.5 V independent of  $V_{CC}$  operating range. Outputs tolerate voltages above  $V_{CC}$  when in the 3-STATE condition.

### Features

- Space Saving US8 Surface Mount Package
- MicroPak™ Pb-Free Leadless Package
- Ultra High Speed:  $t_{PD}$  2.6 ns Typ. into 50 pF at 5 V  $V_{CC}$
- High Output Drive:  $\pm 24$  mA at 3 V  $V_{CC}$
- Broad  $V_{CC}$  Operating Range: 1.65 V to 5.5 V
- Matches the Performance of LCX when Operated at 3.3 V  $V_{CC}$
- Power Down High Impedance Inputs / Outputs
- Overvoltage Tolerant Inputs Facilitate 5 V to 3 V Translation
- Outputs are Overvoltage Tolerant in 3-STATE Mode
- Patented Noise / EMI Reduction Circuitry Implemented
- These Devices are Pb-Free, Halogen Free/BFR Free and are RoHS Compliant

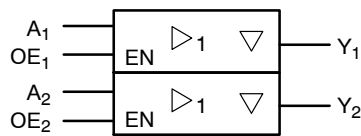
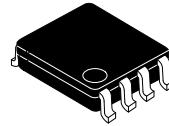

Figure 1. Logic Symbol

### MARKING DIAGRAMS



UQFN8  
1.6X1.6, 0.5P  
CASE 523AY



US8  
CASE 846AN

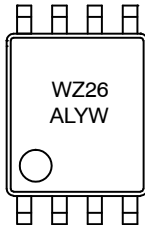

T6, WZ26 = Specific Device Code  
 KK = 2-Digit Lot Run Traceability Code  
 XY = 2-Digit Date Code Format  
 Z = Assembly Plant Code  
 A = Assembly Site  
 L = Wafer Lot Number  
 YW = Assembly Start Week

### ORDERING INFORMATION

See detailed ordering, marking and shipping information in the package dimensions section on page 6 of this data sheet.

# NC7WZ126

## Connection Diagrams

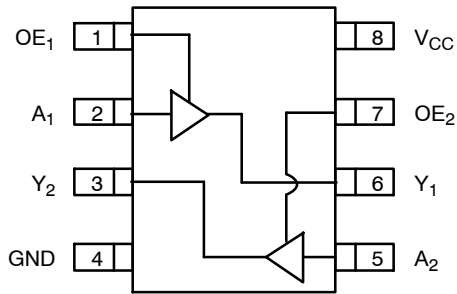

Figure 2. Connection Diagram (Top View)

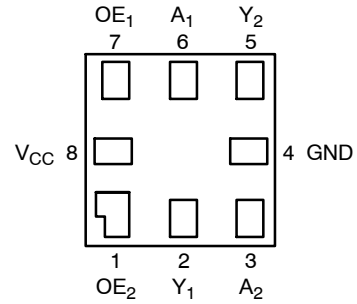

Figure 3. Pad Assignments for MicroPak (Top Thru View)

## PIN DESCRIPTIONS

Pin Names	Description
$OE_n$	Enable Inputs for 3-STATE Outputs
$A_n$	Inputs
$Y_n$	3-STATE Outputs

## FUNCTION TABLE

Inputs		Output
OE	$A_n$	$Y_n$
H	L	L
H	H	H
L	L	Z
L	H	Z

H = HIGH Logic Level  
 L = LOW Logic Level  
 Z = 3-STATE

**ABSOLUTE MAXIMUM RATINGS**

Symbol	Parameter		Min	Max	Unit
V <sub>CC</sub>	Supply Voltage		-0.5	6.5	V
V <sub>IN</sub>	DC Input Voltage (Note 1)		-0.5	6.5	V
V <sub>OUT</sub>	DC Output Voltage		-0.5	6.5	V
I <sub>IK</sub>	DC Input Diode Current	V <sub>IN</sub> < 0 V	-	-50	mA
I <sub>OK</sub>	DC Output Diode Current	V <sub>OUT</sub> < 0 V	-	-50	mA
I <sub>OUT</sub>	DC Output Source / Sink Current		-	±50	mA
I <sub>CC</sub> / I <sub>GND</sub>	DC V <sub>CC</sub> / GND Current		-	±100	mA
T <sub>STG</sub>	Storage Temperature Range		-65	+150	°C
T <sub>J</sub>	Junction Temperature under Bias		-	+150	°C
T <sub>L</sub>	Junction Lead Temperature (Soldering, 10 Seconds)		-	+260	°C
P <sub>D</sub>	Power Dissipation in Still Air		US8	500	mW
			MicroPak-8	539	

Stresses exceeding those listed in the Maximum Ratings table may damage the device. If any of these limits are exceeded, device functionality should not be assumed, damage may occur and reliability may be affected.

1. The input and output negative voltage ratings may be exceeded if the input and output diode current ratings are observed.

**RECOMMENDED OPERATING CONDITIONS**

Symbol	Parameter		Min	Max	Unit
V <sub>CC</sub>	Supply Voltage Operating		1.65	5.5	V
	Supply Voltage Data Retention		1.5	5.5	
V <sub>IN</sub>	Input Voltage		0	5.5	V
V <sub>OUT</sub>	Output Voltage	Active State	0	V <sub>CC</sub>	V
		3-State	0	5.5	V
T <sub>A</sub>	Operating Temperature		-40	+85	°C
t <sub>r</sub> , t <sub>f</sub>	Input Rise and Fall Time	V <sub>CC</sub> = 1.8 V ±0.15 V, 2.5 V ±0.2 V	0	20	ns/V
		V <sub>CC</sub> = 3.3 V ±0.3 V	0	10	
		V <sub>CC</sub> = 5.0 V ±0.5 V	0	5	
θ <sub>JA</sub>	Thermal Resistance		US8	250	°C/W
			MicroPak-8	232	

Functional operation above the stresses listed in the Recommended Operating Ranges is not implied. Extended exposure to stresses beyond the Recommended Operating Ranges limits may affect device reliability.

2. Unused inputs must be held HIGH or LOW. They may not float.

# NC7WZ126

## DC ELECTRICAL CHARACTERISTICS

Symbol	Parameter	Conditions	V <sub>CC</sub> (V)	T <sub>A</sub> = +25°C			T <sub>A</sub> = -40 to +85°C		Unit		
				Min	Typ	Max	Min	Max			
V <sub>IH</sub>	HIGH Level Input Voltage		1.65 to 1.95	0.65 V <sub>CC</sub>	-	-	0.65 V <sub>CC</sub>	-	V		
			2.3 to 5.5	0.7 V <sub>CC</sub>	-	-	0.7 V <sub>CC</sub>	-			
V <sub>IL</sub>	LOW Level Input Voltage		1.65 to 1.95	-	-	0.35 V <sub>CC</sub>	-	0.35 V <sub>CC</sub>	V		
			2.3 to 5.5	-	-	0.3 V <sub>CC</sub>	-	0.3 V <sub>CC</sub>			
V <sub>OH</sub>	HIGH Level Output Voltage	V <sub>IN</sub> = V <sub>IH</sub> or V <sub>IL</sub>	I <sub>OH</sub> = -100 μA	1.65	1.55	1.65	-	1.55	-	V	
				2.3	2.2	2.3	-	2.2	-		
				3.0	2.9	3.0	-	2.9	-		
				4.5	4.4	4.5	-	4.4	-		
		V <sub>IN</sub> = V <sub>IH</sub> or V <sub>IL</sub>	I <sub>OH</sub> = -4 mA	1.65	1.29	1.52	-	1.29	-		
				I <sub>OH</sub> = -8 mA	2.3	1.9	2.15	-	1.9		-
					I <sub>OH</sub> = -16 mA	3.0	2.4	2.80	-		2.4
				I <sub>OH</sub> = -24 mA	3.0	2.3	2.68	-	2.3		-
					I <sub>OH</sub> = -32 mA	4.5	3.8	4.20	-		3.8
				V <sub>OL</sub>		LOW Level Output Voltage	V <sub>IN</sub> = V <sub>IH</sub> or V <sub>IL</sub>	I <sub>OL</sub> = 100 μA	1.65		-
2.3	-	0.0	0.10		-				0.10		
3.0	-	0.0	0.10		-				0.10		
4.5	-	0.0	0.10		-				0.10		
V <sub>IN</sub> = V <sub>IH</sub> or V <sub>IL</sub>	I <sub>OL</sub> = 4 mA	1.65	-		0.08		0.24	-	0.24		
		I <sub>OL</sub> = 8 mA	2.3		-		0.10	0.3	-	0.3	
			I <sub>OL</sub> = 16 mA		3.0		-	0.15	0.4	-	0.4
		I <sub>OL</sub> = 24 mA	3.0		-		0.22	0.55	-	0.55	
			I <sub>OL</sub> = 32 mA		4.5		-	0.22	0.55	-	0.55
		I <sub>IN</sub>			Input Leakage Current		V <sub>IN</sub> = 5.5 V, GND	1.65 to 5.5	-	-	±0.1
I <sub>OZ</sub>	3-STATE Output Leakage	V <sub>IN</sub> = V <sub>IH</sub> or V <sub>IL</sub> 0 ≤ V <sub>OUT</sub> ≤ 5.5 V	1.65 to 5.5	-	-	±0.5	-	±5	μA		
I <sub>OFF</sub>	Power Off Leakage Current	V <sub>IN</sub> or V <sub>OUT</sub> = 5.5 V	0.0	-	-	1	-	10	μA		
I <sub>CC</sub>	Quiescent Supply Current	V <sub>IN</sub> = 5.5 V, GND	1.65 to 5.5	-	-	1	-	10	μA		

## NOISE CHARACTERISTICS

Symbol	Parameter	Conditions	V <sub>CC</sub> (V)	T <sub>A</sub> = +25°C		Unit
				Typ	Max	
V <sub>OLP</sub> (Note 3)	Quiet Output Maximum Dynamic V <sub>OL</sub>	C <sub>L</sub> = 50 pF	5.0	-	1.0	V
V <sub>OLV</sub> (Note 3)	Quiet Output Minimum Dynamic V <sub>OL</sub>	C <sub>L</sub> = 50 pF	5.0	-	1.0	V
V <sub>OHV</sub> (Note 3)	Quiet Output Minimum Dynamic V <sub>OH</sub>	C <sub>L</sub> = 50 pF	5.0	-	4.0	V
V <sub>IHD</sub> (Note 3)	Minimum HIGH Level Dynamic Input Voltage	C <sub>L</sub> = 50 pF	5.0	-	3.5	V
V <sub>ILD</sub> (Note 3)	Maximum LOW Level Dynamic Input Voltage	C <sub>L</sub> = 50 pF	5.0	-	1.5	V

3. Parameter guaranteed by design.

AC ELECTRICAL CHARACTERISTICS

Symbol	Parameter	Conditions	V <sub>CC</sub> (V)	T <sub>A</sub> = +25°C			T <sub>A</sub> = -40 to +85°C		Unit
				Min	Typ	Max	Min	Max	
t <sub>PLH</sub> t <sub>PHL</sub>	Propagation Delay A <sub>n</sub> to Y <sub>n</sub> (Figure 4, 6)	C <sub>L</sub> = 15 pF RD = 1 MΩ S <sub>1</sub> = OPEN	1.8 ±0.15	-	-	12.0	-	13.0	ns
			2.5 ±0.2	-	-	7.5	-	8.0	
			3.3 ±0.3	-	-	5.2	-	5.5	
			5.0 ±0.5	-	-	4.5	-	4.8	
		C <sub>L</sub> = 50 pF, RD = 500 Ω S <sub>1</sub> = OPEN	3.3 ±0.3	-	-	5.7	-	6.0	
			5.0 ±0.5	-	-	5.0	-	5.3	
t <sub>OSLH</sub> t <sub>OSSL</sub>	Output to Output Skew (Note 4) (Figure 4, 6)	C <sub>L</sub> = 50 pF, RD = 500 Ω S <sub>1</sub> = OPEN	3.3 ±0.3	-	-	1.0	-	1.0	ns
			5.0 ±0.5	-	-	0.8	-	0.8	
t <sub>PZL</sub> t <sub>PZH</sub>	Output Enable Time (Figure 4, 6)	C <sub>L</sub> = 50 pF RD,RU = 500 Ω S <sub>1</sub> = GND for t <sub>PZH</sub> S <sub>1</sub> = V <sub>I</sub> for t <sub>PZL</sub> V <sub>I</sub> = 2 x V <sub>CC</sub>	1.8 ±0.15	-	-	14.0	-	15.0	ns
			2.5 ±0.2	-	-	8.5	-	9.0	
			3.3 ±0.3	-	-	6.2	-	6.5	
			5.0 ±0.5	-	-	5.5	-	5.8	
t <sub>PLZ</sub> t <sub>PHZ</sub>	Output Disable Time (Figure 4, 6)	C <sub>L</sub> = 50 pF RD,RU = 500 Ω S <sub>1</sub> = GND for t <sub>PZH</sub> S <sub>1</sub> = V <sub>I</sub> for t <sub>PZL</sub> V <sub>I</sub> = 2 x V <sub>CC</sub>	1.8 ±0.15	-	-	12.0	-	13.0	ns
			2.5 ±0.2	-	-	8.0	-	8.5	
			3.3 ±0.3	-	-	5.7	-	6.0	
			5.0 ±0.5	-	-	4.7	-	5.0	
C <sub>IN</sub>	Input Capacitance		0	-	2.5	-	-	-	pF
C <sub>OUT</sub>	Output Capacitance		5.0	-	4	-	-	-	pF
C <sub>PD</sub>	Power Dissipation Capacitance (Figure 5)	(Note 5)	3.3	-	10	-	-	-	pF
			5.0	-	12	-	-	-	

4. Parameter guaranteed by design. t<sub>OSLH</sub> = |t<sub>PLHmax</sub> - t<sub>PLHmin</sub>|; t<sub>OSSL</sub> = |t<sub>PHLmax</sub> - t<sub>PHLmin</sub>|.

5. C<sub>PD</sub> is defined as the value of the internal equivalent capacitance which is derived from dynamic operating current consumption (I<sub>CCD</sub>) at no output loading and operating at 50% duty cycle. (see Figure 5) C<sub>PD</sub> is related to I<sub>CCD</sub> dynamic operating current by the expression:  
I<sub>CCD</sub> = (C<sub>PD</sub>) (V<sub>CC</sub>) (f<sub>IN</sub>) + (I<sub>CCstatic</sub>).

AC Loading and Waveforms

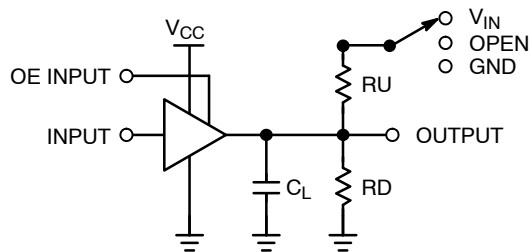

$C_L$  includes load and stray capacitance  
 Input PRR = 1.0 MHz;  $t_W = 500$  ns

Figure 4. AC Test Circuit

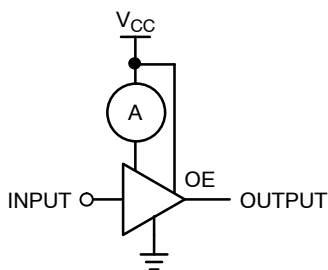

Input = AC Waveform;  $t_r = t_f = 1.8$  ns;  
 PRR = 10 MHz; Duty Cycle = 50%.

Figure 5.  $I_{CCD}$  Test Circuit

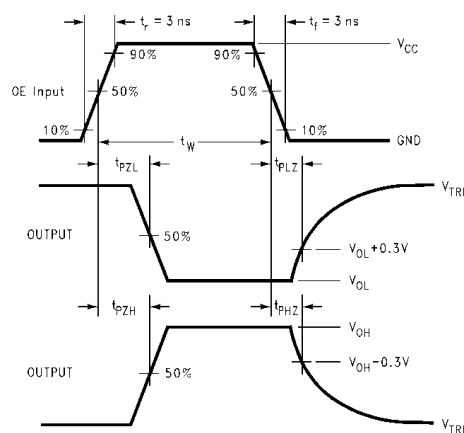
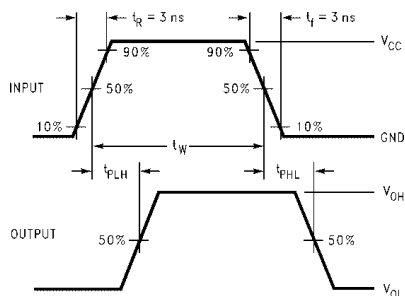

Figure 6. AC Waveforms

ORDERING INFORMATION

Order Number	Top Mark	Package	Shipping <sup>†</sup>
NC7WZ126K8X	WZ26	8-Lead US8, JEDEC MO-187, Variation CA 3.1 mm Wide	3000 / Tape & Reel
NC7WZ126L8X	T6	8-Lead MicroPak, 1.6 mm Wide (Pb-Free)	5000 / Tape & Reel
NC7WZ126L8X-L22185	T6	8-Lead MicroPak, 1.6 mm Wide (Pb-Free)	5000 / Tape & Reel

<sup>†</sup>For information on tape and reel specifications, including part orientation and tape sizes, please refer to our Tape and Reel Packaging Specifications Brochure, BRD8011/D.

6. Pb-Free package per JEDEC J-STD-020B.

**UQFN8 1.6X1.6, 0.5P**  
CASE 523AY  
ISSUE O

DATE 31 AUG 2016



**RECOMMENDED  
LAND PATTERN**

**NOTES:**

- A. PACKAGE CONFORMS TO JEDEC MO-255 VARIATION UAAD.
- B. DIMENSIONS ARE IN MILLIMETERS.
- C. DIMENSIONS AND TOLERANCES PER ASME Y14.5M, 2009.
- D. LAND PATTERN RECOMMENDATION IS EXISTING INDUSTRY LAND PATTERN.

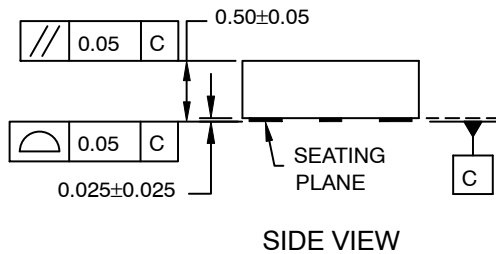

**SIDE VIEW**

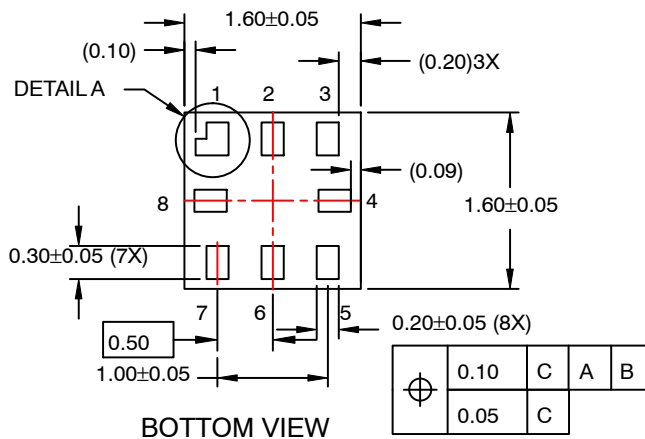

**BOTTOM VIEW**

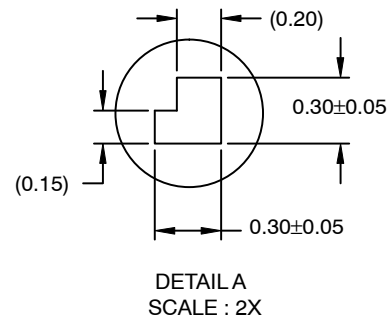

**DETAIL A  
SCALE : 2X**

<b>DOCUMENT NUMBER:</b>	<b>98AON13591G</b>	Electronic versions are uncontrolled except when accessed directly from the Document Repository. Printed versions are uncontrolled except when stamped "CONTROLLED COPY" in red.
<b>DESCRIPTION:</b>	<b>UQFN8 1.6X1.6, 0.5P</b>	<b>PAGE 1 OF 1</b>

ON Semiconductor and **ON** are trademarks of Semiconductor Components Industries, LLC dba ON Semiconductor or its subsidiaries in the United States and/or other countries. ON Semiconductor reserves the right to make changes without further notice to any products herein. ON Semiconductor makes no warranty, representation or guarantee regarding the suitability of its products for any particular purpose, nor does ON Semiconductor assume any liability arising out of the application or use of any product or circuit, and specifically disclaims any and all liability, including without limitation special, consequential or incidental damages. ON Semiconductor does not convey any license under its patent rights nor the rights of others.



US8  
CASE 846AN  
ISSUE O

DATE 31 DEC 2016



**NOTES:**

- A. CONFORMS TO JEDEC REGISTRATION MO-187
- B. DIMENSIONS ARE IN MILLIMETERS.
- C. DIMENSIONS ARE EXCLUSIVE OF BURRS, MOLD FLASH, AND TIE BAR EXTRUSIONS.
- D. DIMENSIONS AND TOLERANCES PER ANSI Y14.5M, 1994.



<b>DOCUMENT NUMBER:</b>	98AON13778G	Electronic versions are uncontrolled except when accessed directly from the Document Repository. Printed versions are uncontrolled except when stamped "CONTROLLED COPY" in red.
<b>DESCRIPTION:</b>	US8	<b>PAGE 1 OF 1</b>

ON Semiconductor and are trademarks of Semiconductor Components Industries, LLC dba ON Semiconductor or its subsidiaries in the United States and/or other countries. ON Semiconductor reserves the right to make changes without further notice to any products herein. ON Semiconductor makes no warranty, representation or guarantee regarding the suitability of its products for any particular purpose, nor does ON Semiconductor assume any liability arising out of the application or use of any product or circuit, and specifically disclaims any and all liability, including without limitation special, consequential or incidental damages. ON Semiconductor does not convey any license under its patent rights nor the rights of others.



**onsemi**, **Onsemi**, and other names, marks, and brands are registered and/or common law trademarks of Semiconductor Components Industries, LLC dba "**onsemi**" or its affiliates and/or subsidiaries in the United States and/or other countries. **onsemi** owns the rights to a number of patents, trademarks, copyrights, trade secrets, and other intellectual property. A listing of **onsemi**'s product/patent coverage may be accessed at [www.onsemi.com/site/pdf/Patent-Marking.pdf](http://www.onsemi.com/site/pdf/Patent-Marking.pdf). **onsemi** reserves the right to make changes at any time to any products or information herein, without notice. The information herein is provided "as-is" and **onsemi** makes no warranty, representation or guarantee regarding the accuracy of the information, product features, availability, functionality, or suitability of its products for any particular purpose, nor does **onsemi** assume any liability arising out of the application or use of any product or circuit, and specifically disclaims any and all liability, including without limitation special, consequential or incidental damages. Buyer is responsible for its products and applications using **onsemi** products, including compliance with all laws, regulations and safety requirements or standards, regardless of any support or applications information provided by **onsemi**. "Typical" parameters which may be provided in **onsemi** data sheets and/or specifications can and do vary in different applications and actual performance may vary over time. All operating parameters, including "Typicals" must be validated for each customer application by customer's technical experts. **onsemi** does not convey any license under any of its intellectual property rights nor the rights of others. **onsemi** products are not designed, intended, or authorized for use as a critical component in life support systems or any FDA Class 3 medical devices or medical devices with a same or similar classification in a foreign jurisdiction or any devices intended for implantation in the human body. Should Buyer purchase or use **onsemi** products for any such unintended or unauthorized application, Buyer shall indemnify and hold **onsemi** and its officers, employees, subsidiaries, affiliates, and distributors harmless against all claims, costs, damages, and expenses, and reasonable attorney fees arising out of, directly or indirectly, any claim of personal injury or death associated with such unintended or unauthorized use, even if such claim alleges that **onsemi** was negligent regarding the design or manufacture of the part. **onsemi** is an Equal Opportunity/Affirmative Action Employer. This literature is subject to all applicable copyright laws and is not for resale in any manner.

## PUBLICATION ORDERING INFORMATION

### LITERATURE FULFILLMENT:

Email Requests to: [orderlit@onsemi.com](mailto:orderlit@onsemi.com)

**onsemi Website:** [www.onsemi.com](http://www.onsemi.com)

### TECHNICAL SUPPORT

**North American Technical Support:**

Voice Mail: 1 800-282-9855 Toll Free USA/Canada

Phone: 011 421 33 790 2910

**Europe, Middle East and Africa Technical Support:**

Phone: 00421 33 790 2910

For additional information, please contact your local Sales Representative