

# NCV8450, NCV8450A

## Self-Protected High Side Driver with Temperature and Current Limit

The NCV8450/A is a fully protected High-Side Smart Discrete device with a typical  $R_{DS(on)}$  of  $1.0\ \Omega$  and an internal current limit of  $0.8\text{ A}$  typical. The device can switch a wide variety of resistive, inductive, and capacitive loads.

### Features

- Short Circuit Protection
- Thermal Shutdown with Automatic Restart
- Overvoltage Protection
- Integrated Clamp for Inductive Switching
- Loss of Ground Protection
- ESD Protection
- Slew Rate Control for Low EMI
- Very Low Standby Current
- NCV Prefix for Automotive and Other Applications Requiring Unique Site and Control Change Requirements; AEC-Q100 Qualified and PPAP Capable
- These Devices are Pb-Free, Halogen Free/BFR Free and are RoHS Compliant

### Typical Applications

- Automotive
- Industrial

### PRODUCT SUMMARY

Symbol	Characteristics	Value	Unit
$V_{IN\_CL}$	Overvoltage Protection	54	V
$V_{D(on)}$	Operation Voltage	4.5 – 45	V
$R_{on}$	On-State Resistance	1.0	$\Omega$



ON Semiconductor®

[www.onsemi.com](http://www.onsemi.com)

### MARKING DIAGRAM



SOT-223  
(TO-261)  
CASE 318E

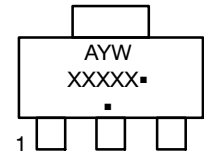

XXXXX = V8450 or 8450A  
A = Assembly Location  
Y = Year  
W = Work Week  
▪ = Pb-Free Package

(Note: Microdot may be in either location)

### ORDERING INFORMATION

See detailed ordering and shipping information in the package dimensions section on page 8 of this data sheet.

# NCV8450, NCV8450A

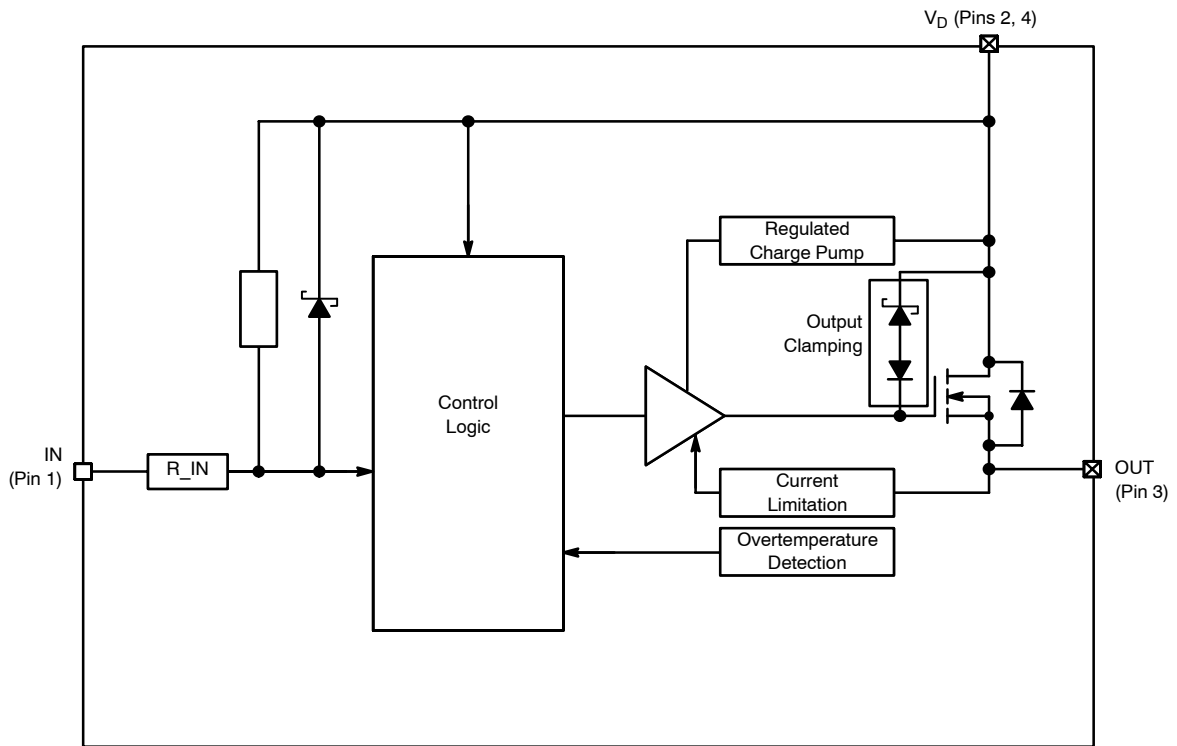

Figure 1. Block Diagram

## PACKAGE PIN DESCRIPTION

Pin #	Symbol	Description
1	IN	Control Input, Active Low
2	$V_D$	Supply Voltage
3	OUT	Output
4	$V_D$	Supply Voltage

# NCV8450, NCV8450A

## MAXIMUM RATINGS

Rating	Symbol	Value		Unit
		Min	Max	
DC Supply Voltage (Note 1)	$V_D$	-16	45	V
Load Dump Protection ( $R_I = 2 \Omega$ , $t_d = 400 \text{ ms}$ , $V_{IN} = 0, 10 \text{ V}$ , $I_L = 150 \text{ mA}$ , $V_{bb} = 13.5 \text{ V}$ )	$V_{\text{LoadDump}}$		85	V
Input Current	$I_{in}$	-15	15	mA
Output Current (Note 1)	$I_{out}$		Internally Limited	A
Total Power Dissipation @ $T_A = 25^\circ\text{C}$ (Note 2) @ $T_A = 25^\circ\text{C}$ (Note 3)	$P_D$		1.13 1.60	W
Electrostatic Discharge (Note 4) (Human Body Model (HBM) 100 pF/1500 $\Omega$ ) Input All other			1 5	kV
Single Pulse Inductive Load Switching Energy (Note 4) ( $V_{DD} = 13.5 \text{ V}$ , $I = 465 \text{ mA}$ , $L = 200 \text{ mH}$ , $T_{J\text{Start}} = 150^\circ\text{C}$ )	$E_{AS}$		29	mJ
Operating Junction Temperature	$T_J$	-40	+150	$^\circ\text{C}$
Storage Temperature	$T_{\text{storage}}$	-55	+150	$^\circ\text{C}$

Stresses exceeding those listed in the Maximum Ratings table may damage the device. If any of these limits are exceeded, device functionality should not be assumed, damage may occur and reliability may be affected.

1. Reverse Output current has to be limited by the load to stay within absolute maximum ratings and thermal performance.
2. Minimum Pad.
3. 1 in square pad size, FR-4, 1 oz Cu.
4. Not subjected to production testing.

## THERMAL RESISTANCE RATINGS

Parameter	Symbol	Max Value	Unit
Thermal Resistance (Note 5) Junction-to-Ambient (Note 2) Junction-to-Ambient (Note 3)	$R_{\theta JA}$ $R_{\theta JA}$	110 78.3	K/W

5. Not subjected to production testing.

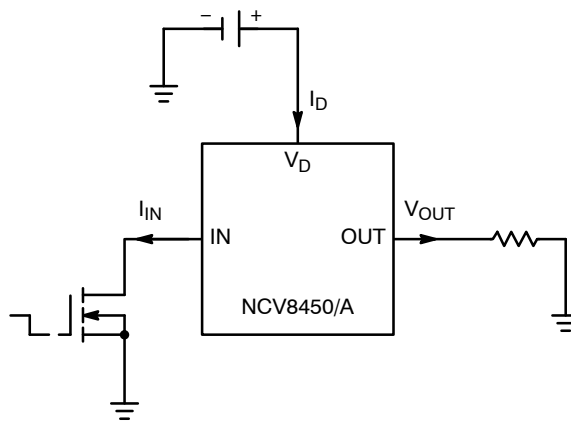

**Figure 2. Applications Test Circuit**

# NCV8450, NCV8450A

## ELECTRICAL CHARACTERISTICS ( $6 \leq V_D \leq 45 \text{ V}$ ; $-40^\circ\text{C} < T_J < 150^\circ\text{C}$ unless otherwise specified)

Rating	Symbol	Conditions	Value			Unit
			Min	Typ	Max	

### OUTPUT CHARACTERISTICS

Operating Supply Voltage	$V_{\text{SUPPLY}}$		4.5	-	45	V
On Resistance (Pin 1 Connected to GND)	$R_{\text{ON}}$	$T_J = 25^\circ\text{C}$ , $I_{\text{OUT}} = 150 \text{ mA}$ , $V_D = 7 \text{ V} - 45 \text{ V}$ $T_J = 150^\circ\text{C}$ , $I_{\text{OUT}} = 150 \text{ mA}$ , $V_D = 7 \text{ V} - 45 \text{ V}$ (Note 6) $T_J = 25^\circ\text{C}$ , $I_{\text{OUT}} = 150 \text{ mA}$ , $V_D = 6 \text{ V}$		1.0 1.4	2 3	$\Omega$
Standby Current (Pin 1 Open)	$I_D$	$V_D \leq 20 \text{ V}$ $V_D > 20 \text{ V}$		0.6	10 100	$\mu\text{A}$

### INPUT CHARACTERISTICS

Input Current – Off State	$I_{\text{IN\_OFF}}$	$V_{\text{OUT}} \leq 0.1 \text{ V}$ , $R_L = 270 \Omega$ , $T_J = 25^\circ\text{C}$ $V_{\text{OUT}} \leq 0.1 \text{ V}$ , $R_L = 270 \Omega$ , $T_J = 150^\circ\text{C}$ (Note 6)	-50 -40			$\mu\text{A}$
Input Current – On State (Pin 1 Grounded)	$I_{\text{IN\_ON}}$			1.5	3	mA
Input Resistance (Note 6)	$R_{\text{IN}}$			1		k $\Omega$

### SWITCHING CHARACTERISTICS

Turn-On Time (Note 7) ( $V_{\text{IN}} = V_D$ to 0 V) to 90% $V_{\text{OUT}}$	$t_{\text{ON}}$	$R_L = 270 \Omega$ (Note 6) $V_D = 13.5 \text{ V}$ , $R_L = 270 \Omega$ , $T_J = 25^\circ\text{C}$		30	125 100	$\mu\text{s}$
Turn-Off Time (Note 7) ( $V_{\text{IN}} = 0 \text{ V}$ to $V_D$ ) to 10% $V_{\text{OUT}}$	$t_{\text{OFF}}$	$R_L = 270 \Omega$ (Note 6) $V_D = 13.5 \text{ V}$ , $R_L = 270 \Omega$ , $T_J = 25^\circ\text{C}$		60	175 150	$\mu\text{s}$
Slew Rate On (Note 7) ( $V_{\text{IN}} = V_D$ to 0V) 10% to 30% $V_{\text{OUT}}$	$dV/dt_{\text{ON}}$	$R_L = 270 \Omega$ (Note 6) $V_D = 13.5 \text{ V}$ , $R_L = 270 \Omega$ , $T_J = 25^\circ\text{C}$		0.7	4 4	V/ $\mu\text{s}$
Slew Rate Off (Note 7) ( $V_{\text{IN}} = 0 \text{ V}$ to $V_D$ ) 70% to 40% $V_{\text{OUT}}$	$dV/dt_{\text{OFF}}$	$R_L = 270 \Omega$ (Note 6) $V_D = 13.5 \text{ V}$ , $R_L = 270 \Omega$ , $T_J = 25^\circ\text{C}$		0.9	4 4	V/ $\mu\text{s}$

### OUTPUT DIODE CHARACTERISTICS (Note 6)

Drain-Source Diode Voltage	$V_F$	$I_{\text{OUT}} = -0.2 \text{ A}$		0.6		V
Continuous Reverse Drain Current	$I_S$	$T_J = 25^\circ\text{C}$			0.2	A

### PROTECTION FUNCTIONS (Note 8)

Temperature Shutdown (Note 6)	$T_{\text{SD}}$		150	175	-	$^\circ\text{C}$
Temperature Shutdown Hysteresis (Note 6)	$T_{\text{SD\_HYST}}$			5		$^\circ\text{C}$
Output Current Limit	$I_{\text{LIM}}$	$T_J = -40^\circ\text{C}$ , $V_D = 13.5 \text{ V}$ , $t_m = 100 \mu\text{s}$ (Note 6) $T_J = 25^\circ\text{C}$ , $V_D = 13.5 \text{ V}$ , $t_m = 100 \mu\text{s}$ $T_J = 150^\circ\text{C}$ , $V_D = 13.5 \text{ V}$ , $t_m = 100 \mu\text{s}$ (Note 6)	0.5	0.8	1.5	A
Output Clamp Voltage (Inductive Load Switch Off) At $V_{\text{OUT}} = V_D - V_{\text{CLAMP}}$	$V_{\text{CLAMP}}$	$I_{\text{OUT}} = 4 \text{ mA}$	45	52		V
Overvoltage Protection	$V_{\text{IN\_CL}}$	$I_{\text{CLAMP}} = 4 \text{ mA}$	50	54		V

6. Not subjected to production testing

7. Only valid with high input slew rates

8. Protection functions are not designed for continuous repetitive operation and are considered outside normal operating range

# NCV8450, NCV8450A

## TYPICAL CHARACTERISTIC CURVES

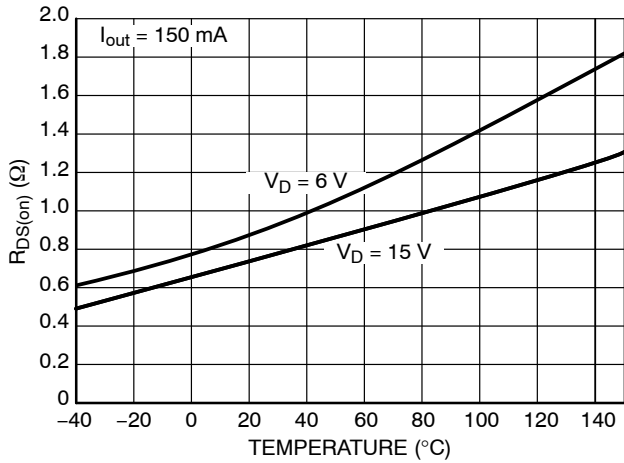

Figure 3.  $R_{DS(on)}$  vs. Temperature

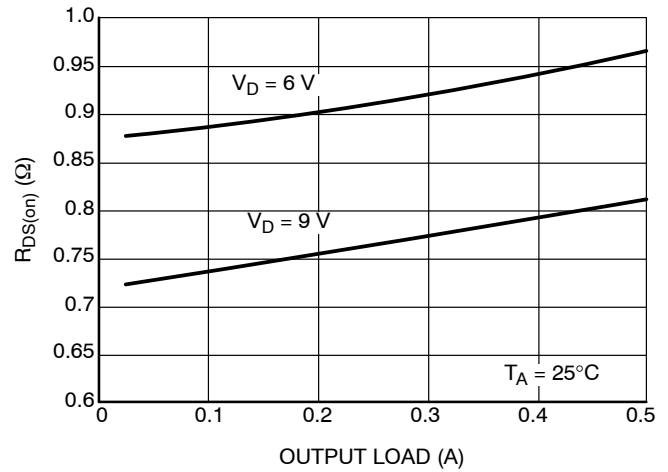

Figure 4.  $R_{DS(on)}$  vs. Output Load

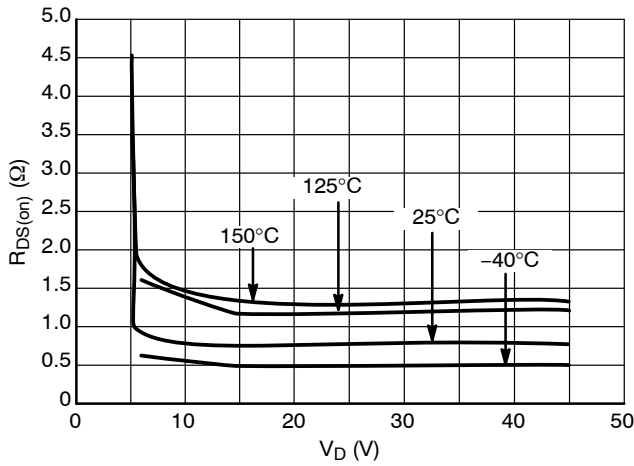

Figure 5.  $R_{DS(on)}$  vs.  $V_D$

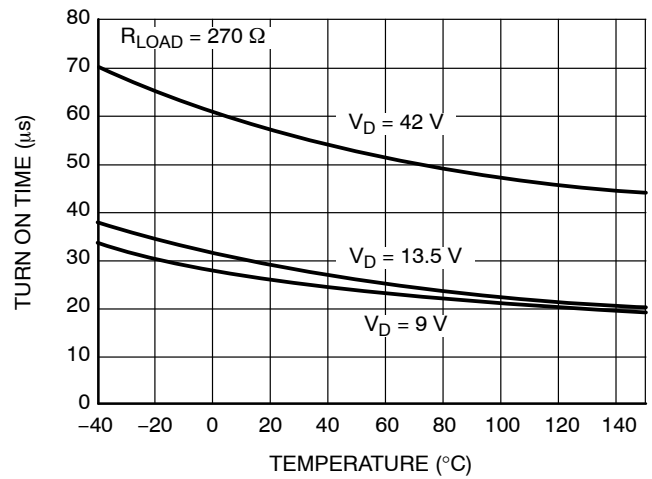

Figure 6. Turn On Time vs. Temperature

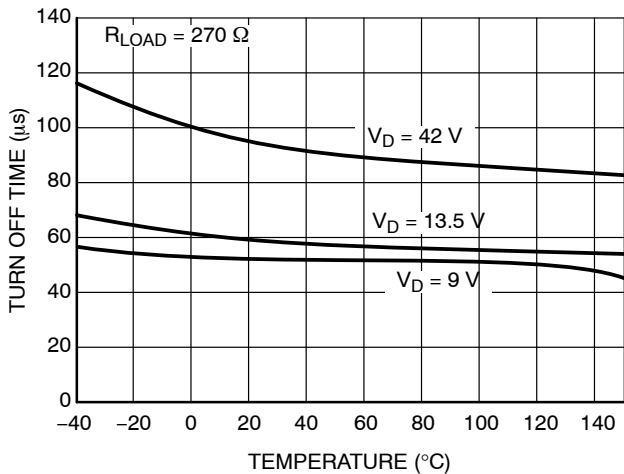

Figure 7. Turn Off Time vs. Temperature

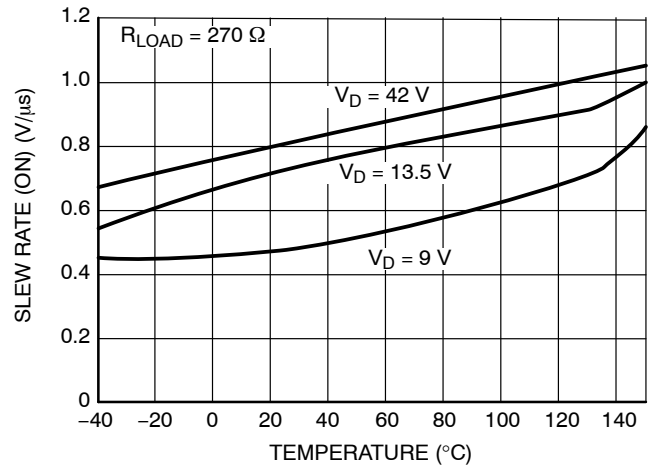

Figure 8. Slew Rate (ON) vs. Temperature

TYPICAL CHARACTERISTIC CURVES

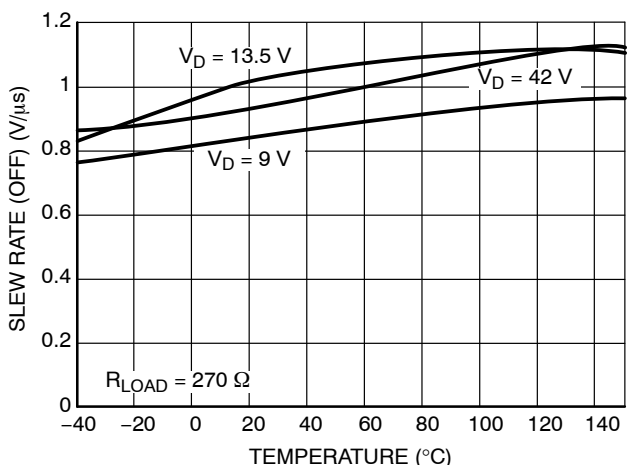

Figure 9. Slew Rate (OFF) vs. Temperature

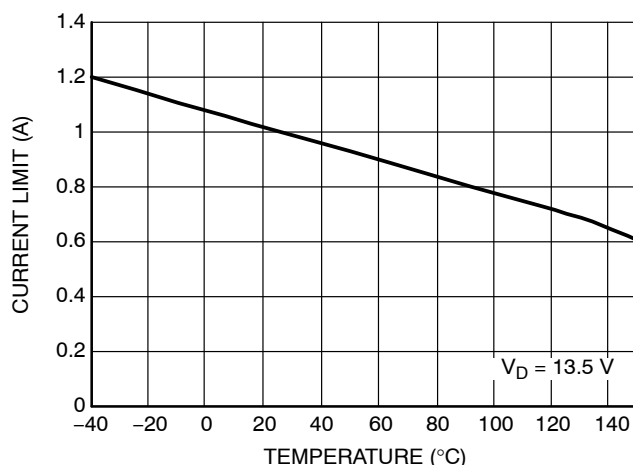

Figure 10. Current Limit vs. Temperature

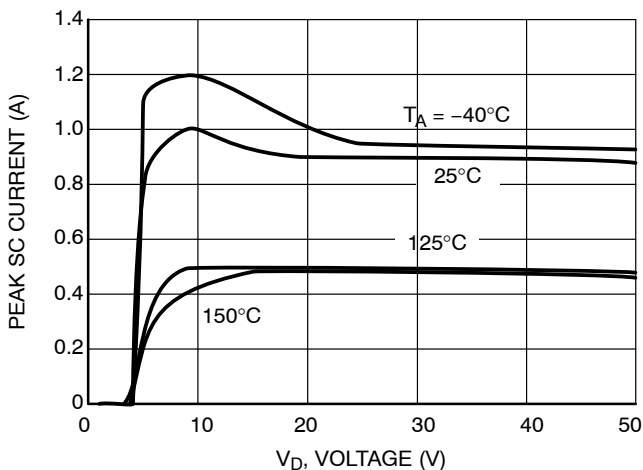

Figure 11. Peak Short Circuit Current vs.  $V_D$  Voltage

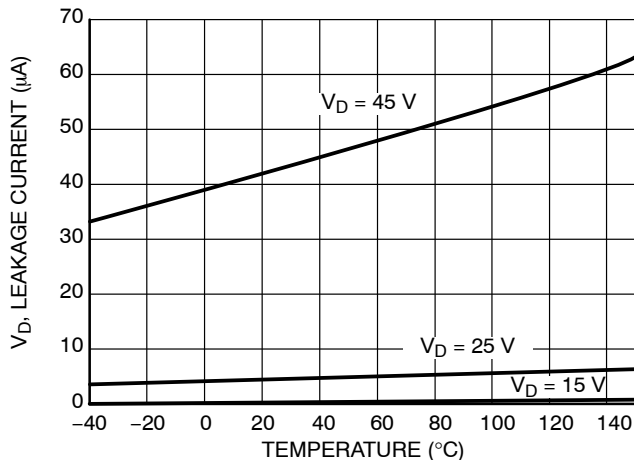

Figure 12.  $V_D$  Leakage Current vs. Temperature Off-State

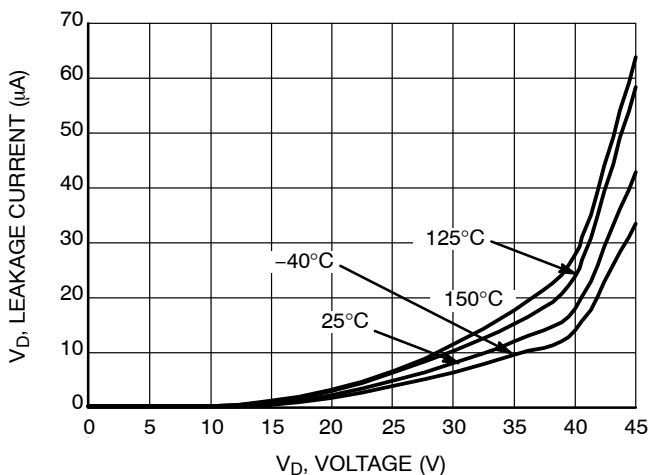

Figure 13.  $V_D$  Leakage Current vs.  $V_D$  Voltage Off-State

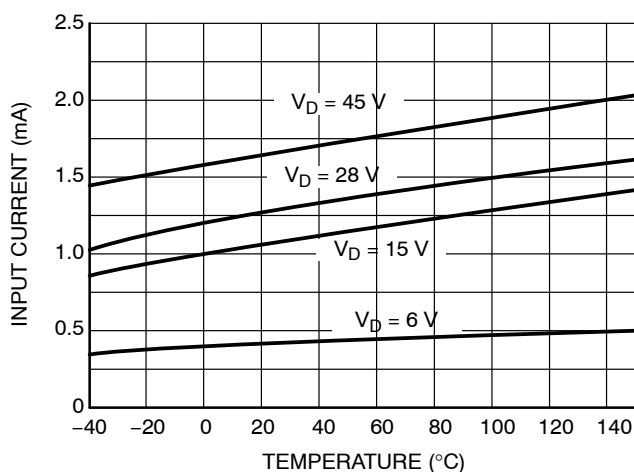

Figure 14. On-State Input Current vs. Temperature

TYPICAL CHARACTERISTIC CURVES

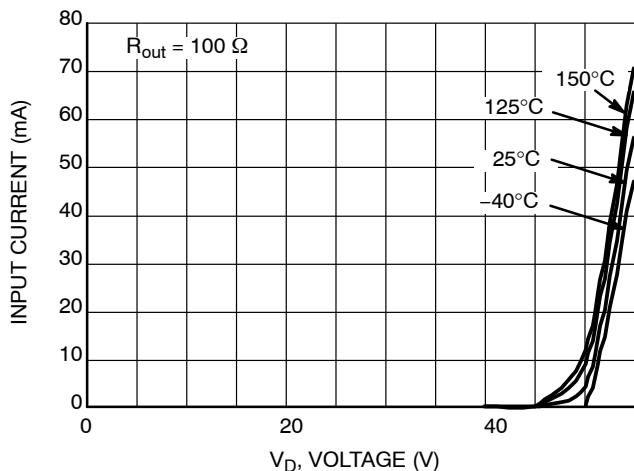

Figure 18. Input Current vs.  $V_D$  Voltage Off-State

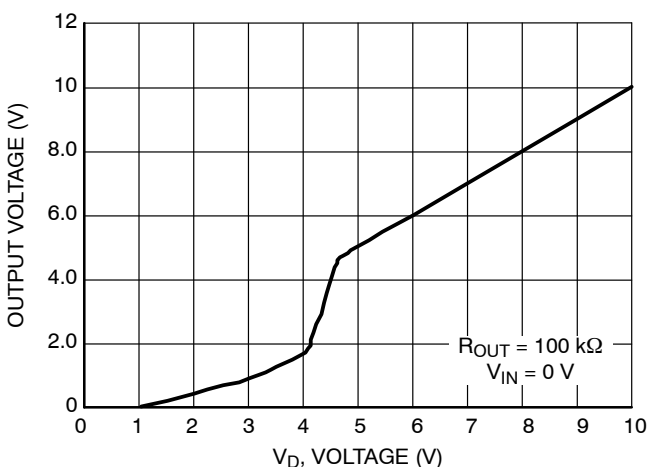

Figure 15. Output Voltage vs.  $V_D$  Voltage

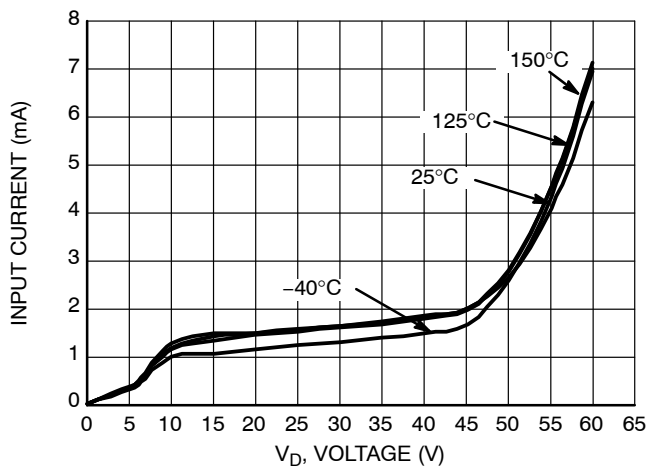

Figure 16. Input Current vs.  $V_D$  Voltage On-State

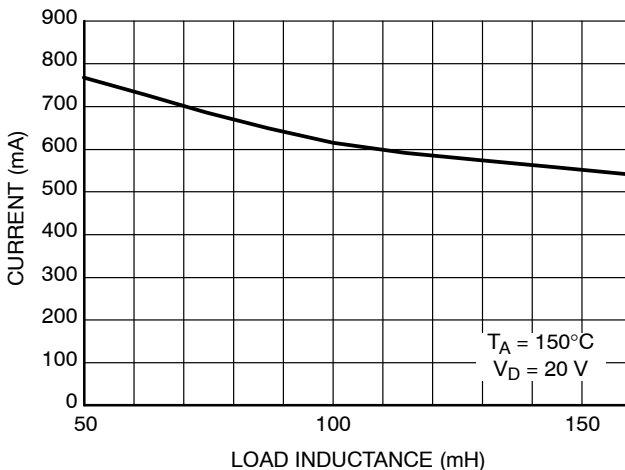

Figure 17. Single Pulse Maximum Switch-off Current vs. Load Inductance

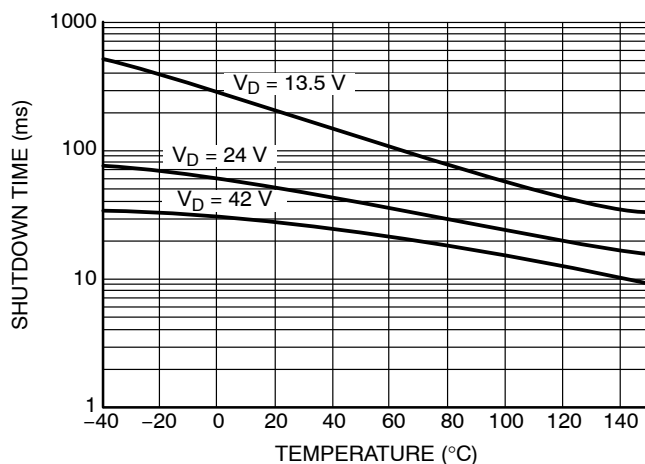

Figure 19. Initial Short-Circuit Shutdown Time vs. Temperature

# NCV8450, NCV8450A

## TYPICAL CHARACTERISTIC CURVES

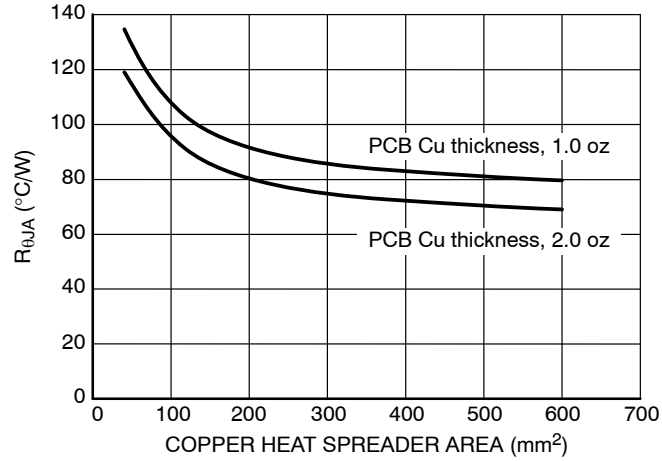

Figure 20. R<sub>θJA</sub> vs. Copper Area

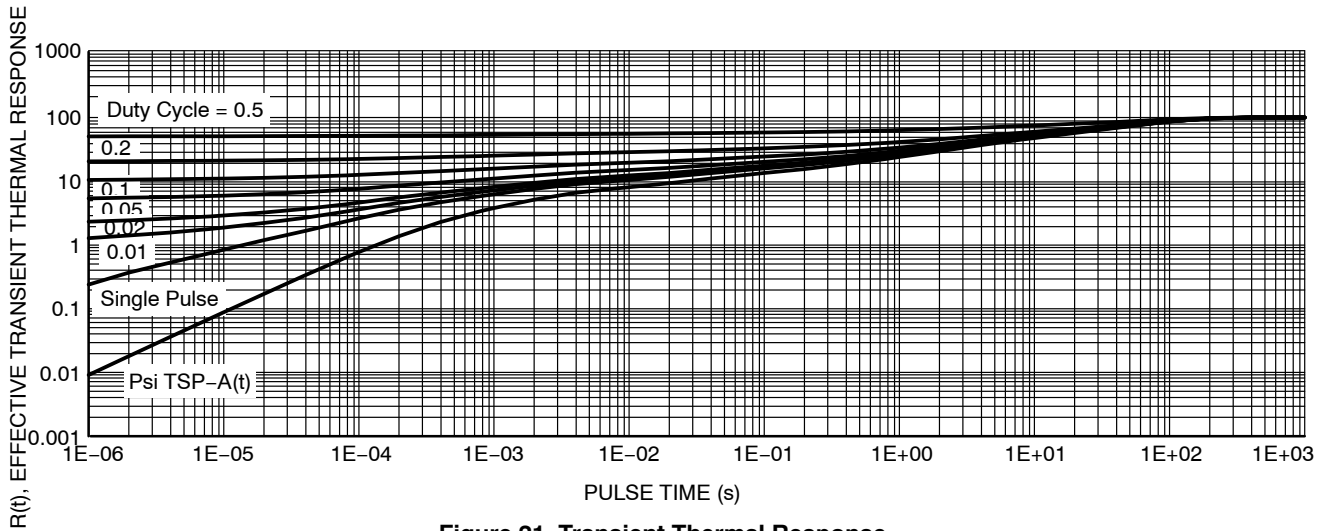

Figure 21. Transient Thermal Response

### ISO PULSE TEST RESULTS

Test Pulse	Test Level	Test Results	Pulse Cycle Time and Generator Impedance
1	200 V	C	500 ms, 10 Ω
2	150 V	C	500 ms, 10 Ω
3a	200 V	C	100 ms, 50 Ω
3b	200 V	C	100 ms, 50 Ω
5	175 V	E(100 V)	400 ms, 2 Ω

### ORDERING INFORMATION

Device	Package	Shipping <sup>†</sup>
NCV8450STT3G	SOT-223 (Pb-Free)	4000 / Tape & Reel
NCV8450ASTT3G	SOT-223 (Pb-Free)	4000 / Tape & Reel

<sup>†</sup>For information on tape and reel specifications, including part orientation and tape sizes, please refer to our Tape and Reel Packaging Specifications Brochure, BRD8011/D.



ON Semiconductor and  are trademarks of Semiconductor Components Industries, LLC dba ON Semiconductor or its subsidiaries in the United States and/or other countries. ON Semiconductor owns the rights to a number of patents, trademarks, copyrights, trade secrets, and other intellectual property. A listing of ON Semiconductor's product/patent coverage may be accessed at [www.onsemi.com/site/pdf/Patent-Marking.pdf](http://www.onsemi.com/site/pdf/Patent-Marking.pdf). ON Semiconductor reserves the right to make changes without further notice to any products herein. ON Semiconductor makes no warranty, representation or guarantee regarding the suitability of its products for any particular purpose, nor does ON Semiconductor assume any liability arising out of the application or use of any product or circuit, and specifically disclaims any and all liability, including without limitation special, consequential or incidental damages. Buyer is responsible for its products and applications using ON Semiconductor products, including compliance with all laws, regulations and safety requirements or standards, regardless of any support or applications information provided by ON Semiconductor. "Typical" parameters which may be provided in ON Semiconductor data sheets and/or specifications can and do vary in different applications and actual performance may vary over time. All operating parameters, including "Typicals" must be validated for each customer application by customer's technical experts. ON Semiconductor does not convey any license under its patent rights nor the rights of others. ON Semiconductor products are not designed, intended, or authorized for use as a critical component in life support systems or any FDA Class 3 medical devices or medical devices with a same or similar classification in a foreign jurisdiction or any devices intended for implantation in the human body. Should Buyer purchase or use ON Semiconductor products for any such unintended or unauthorized application, Buyer shall indemnify and hold ON Semiconductor and its officers, employees, subsidiaries, affiliates, and distributors harmless against all claims, costs, damages, and expenses, and reasonable attorney fees arising out of, directly or indirectly, any claim of personal injury or death associated with such unintended or unauthorized use, even if such claim alleges that ON Semiconductor was negligent regarding the design or manufacture of the part. ON Semiconductor is an Equal Opportunity/Affirmative Action Employer. This literature is subject to all applicable copyright laws and is not for resale in any manner.

## PUBLICATION ORDERING INFORMATION

### LITERATURE FULFILLMENT:

Email Requests to: [orderlit@onsemi.com](mailto:orderlit@onsemi.com)

ON Semiconductor Website: [www.onsemi.com](http://www.onsemi.com)

### TECHNICAL SUPPORT

North American Technical Support:  
Voice Mail: 1 800-282-9855 Toll Free USA/Canada  
Phone: 011 421 33 790 2910

### Europe, Middle East and Africa Technical Support:

Phone: 00421 33 790 2910

For additional information, please contact your local Sales Representative