

Main Product Characteristics

$V_{(BR)DSS}$	-12V
$R_{DS(ON)}$	50m Ω
I_D	-3.5A

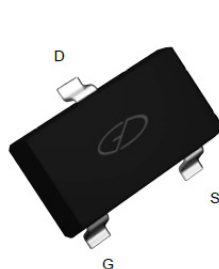

SOT-23

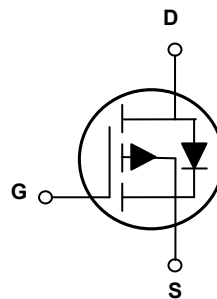

Schematic Diagram

Features and Benefits

- Advanced MOSFET process technology
- Ideal for high efficiency switched mode power supplies
- Low on-resistance with low gate charge
- Fast switching and reverse body recovery



Description

The SSF1341 utilizes the latest techniques to achieve ultra high cell density and low on-resistance. These features make this device extremely efficient and reliable for use in battery protection, load switch, power management and a wide variety of other applications.

Absolute Maximum Ratings ($T_A=25^{\circ}\text{C}$ unless otherwise specified)

Parameter	Symbol	Max.	Unit
Drain-Source Voltage	V_{DS}	-12	V
Gate-Source Voltage	V_{GS}	± 8	V
Drain Current-Continuous ($T_C=25^{\circ}\text{C}$) ¹	I_D	-3.5	A
Drain Current-Continuous ($T_C=70^{\circ}\text{C}$) ¹		-2.6	A
Drain Current-Pulsed ¹	I_{DM}	-14	A
Power Dissipation	P_D	1.25	W
Thermal Resistance, Junction-to-Ambient ²	$R_{\theta JA}$	100	$^{\circ}\text{C}/\text{W}$
Operating Junction Temperature Range	T_J	-55 To +150	$^{\circ}\text{C}$
Storage Temperature Range	T_{STG}	-55 To +150	$^{\circ}\text{C}$

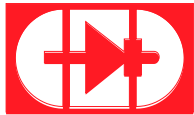
Electrical Characteristics ($T_J=25^\circ\text{C}$ unless otherwise specified)

Parameter	Symbol	Conditions	Min.	Typ.	Max.	Unit
Off Characteristics						
Drain-Source Breakdown Voltage	BV_{DSS}	$V_{GS}=0V, I_D=-250\mu A$	-12	-	-	V
Zero Gate Voltage Drain Current	I_{DSS}	$V_{DS}=-12V, V_{GS}=0V$	-	-	-1	μA
Gate-Source Leakage Current	I_{GSS}	$V_{GS}=\pm 8V, V_{DS}=0V$	-	-	± 100	nA
On Characteristics³						
Gate Threshold Voltage	$V_{GS(th)}$	$V_{GS}=V_{DS}, I_D=-250\mu A$	-0.4	-	-1	V
Drain-Source On-Resistance	$R_{DS(on)}$	$V_{GS}=-4.5V, I_D=-3.5A$	-	41	50	m Ω
		$V_{GS}=-2.5V, I_D=-3A$	-	51	85	m Ω
Forward Transconductance	g_{FS}	$V_{DS}=-5V, I_D=-2.8A$	8	-	-	S
Dynamic and Switching Characteristics⁴						
Input Capacitance	C_{iss}	$V_{DS}=-8V, V_{GS}=0V, F=1MHz$	-	1000	-	pF
Output Capacitance	C_{oss}		-	200	-	
Reverse Transfer Capacitance	C_{rss}		-	150	-	
Turn-On Delay Time	$t_{d(on)}$	$V_{DD}=-10V, I_D=-1A, R_{GEN}=6\Omega, V_{GS}=-4.5V$	-	20	29	nS
Rise Time	t_r		-	19	30	
Turn-Off Delay Time	$t_{d(off)}$		-	39	58	
Fall Time	t_f		-	9	15	
Total Gate Charge	Q_g	$V_{DS}=-8V, I_D=-3.5A, V_{GS}=-4.5V$	-	12	17	nC
Gate-Source Charge	Q_{gs}		-	1.5	-	
Gate-Drain Charge	Q_{gd}		-	3	-	
Drain-Source Diode Characteristics and Maximum Ratings						
Diode Forward Voltage ³	V_{SD}	$V_{GS}=0V, I_S=-1.7A$	-	-0.8	-1.2	V

NOTES:

1. Repetitive rating: Pulsed width limited by maximum junction temperature.
2. Surface Mounted on 1in² FR4 Board, $t \leq 10$ sec.
3. Pulse test: pulse width $\leq 300\mu s$, duty cycle $\leq 2\%$.
4. Guaranteed by design, not subject to production testing.

Typical Electrical and Thermal Characteristic Curves

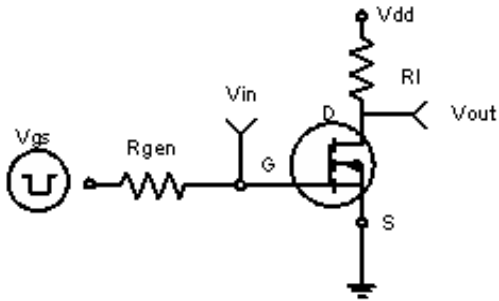

Figure 1. Switching Test Circuit

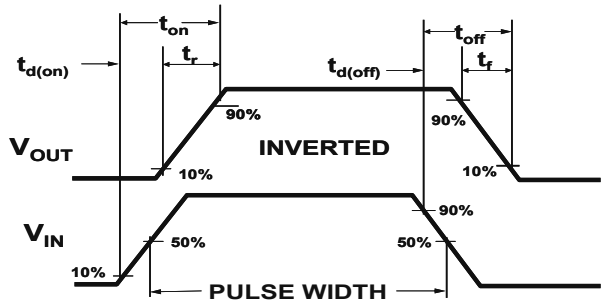

Figure 2. Switching Waveforms

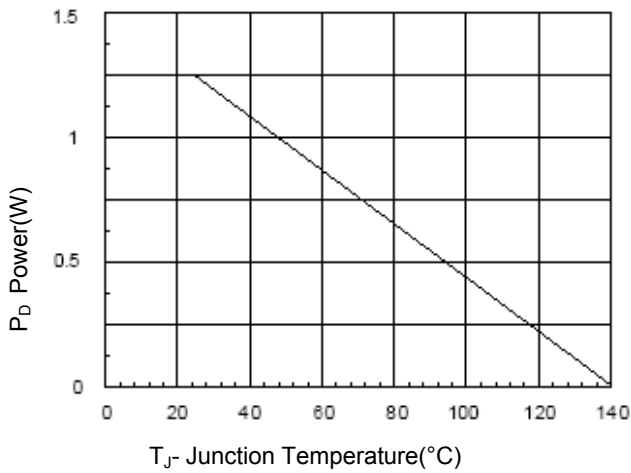

Figure 3. Power Dissipation

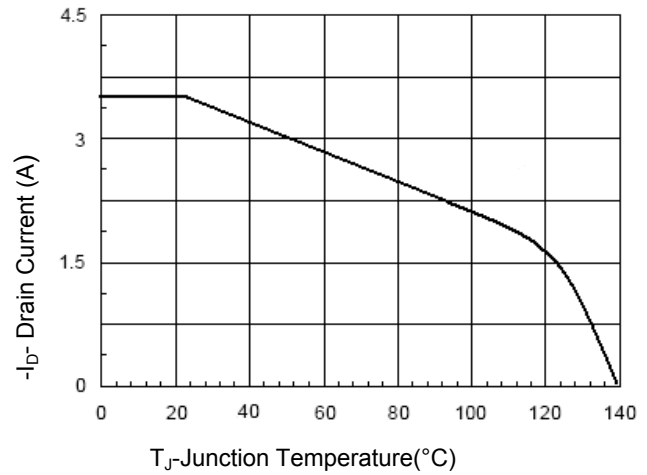

Figure 4. Drain Current vs Junction Temperature

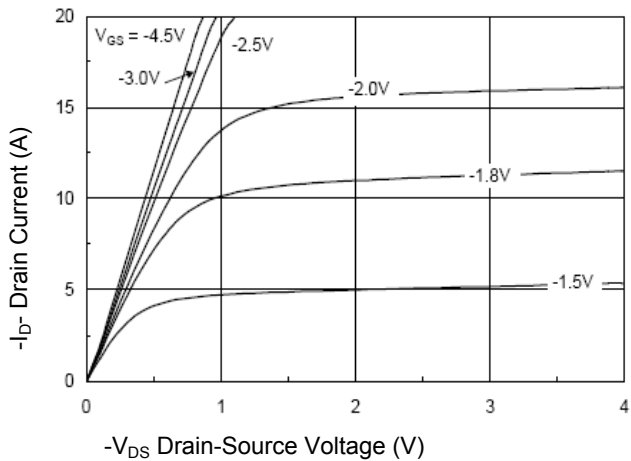

Figure 5. Output Characteristics

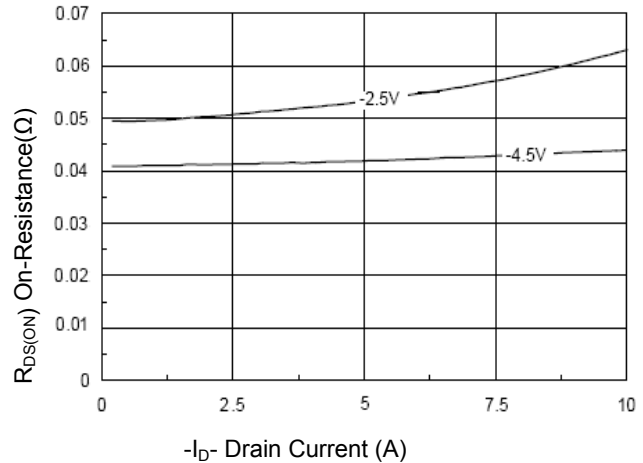

Figure 6. Drain-Source On-Resistance

Typical Electrical and Thermal Characteristic Curves

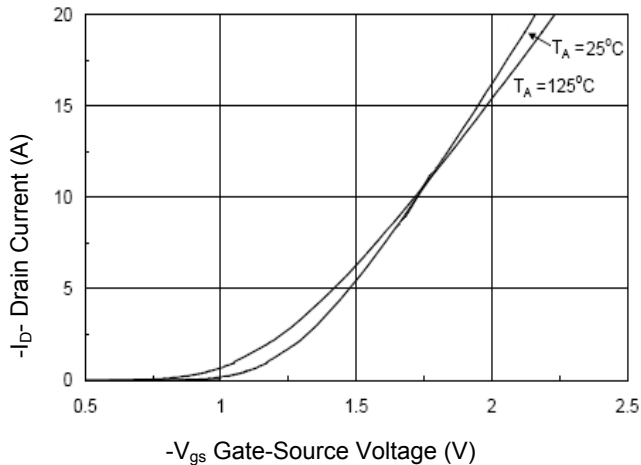

Figure 7. Transfer Characteristics

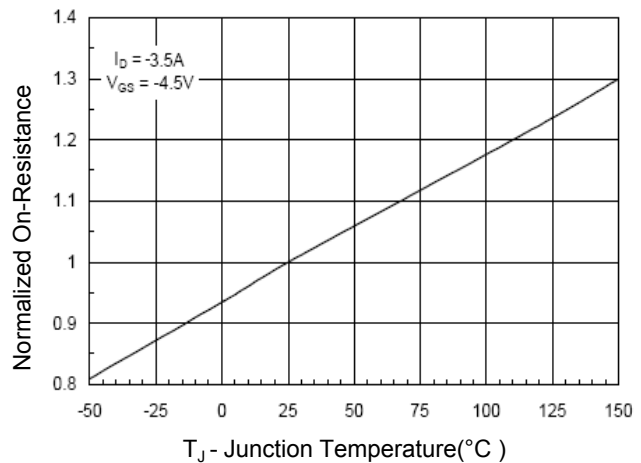

Figure 8. Drain-Source On-Resistance

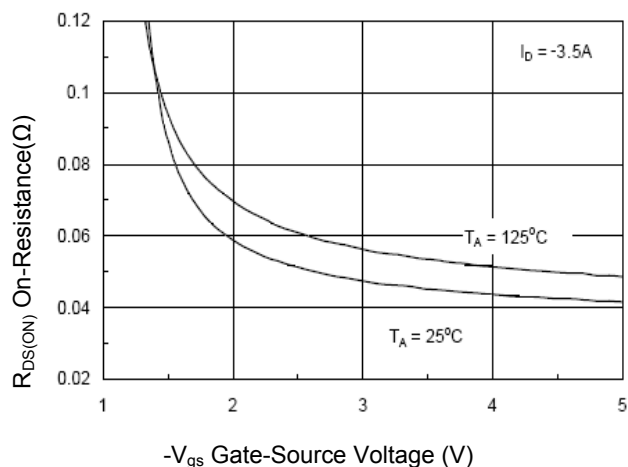

Figure 9. $R_{DS(ON)}$ vs V_{GS}

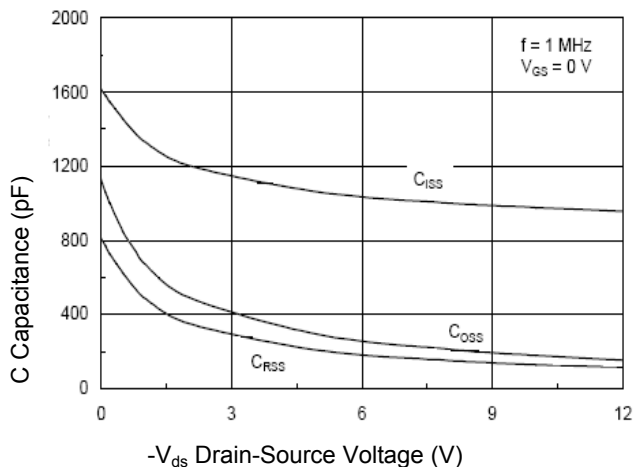

Figure 10. Capacitance vs V_{DS}

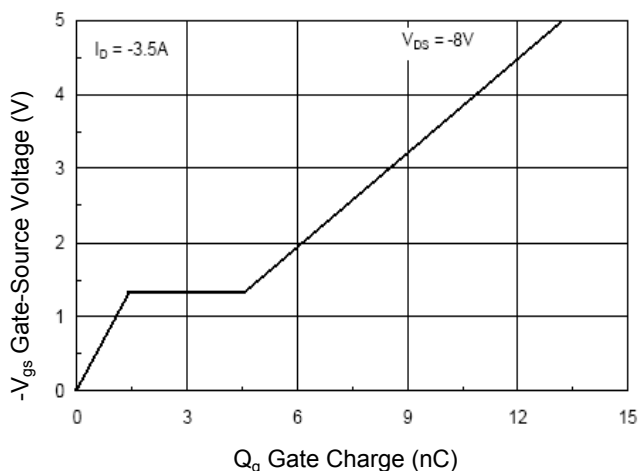

Figure 11. Gate-Source Voltage vs Gate Charge

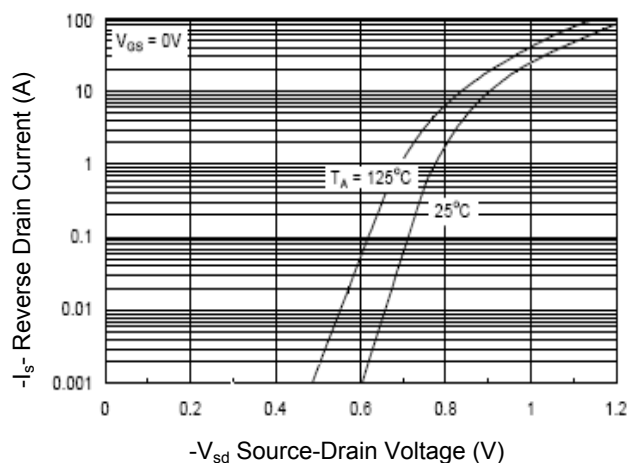

Figure 12. Source- Drain Diode Forward

Typical Electrical and Thermal Characteristic Curves

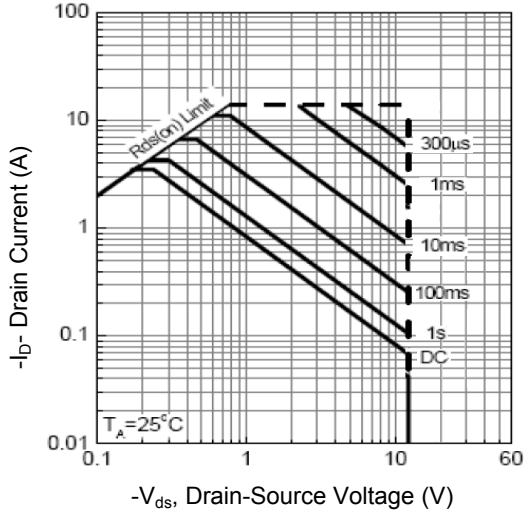

Figure 13. Safe Operation Area

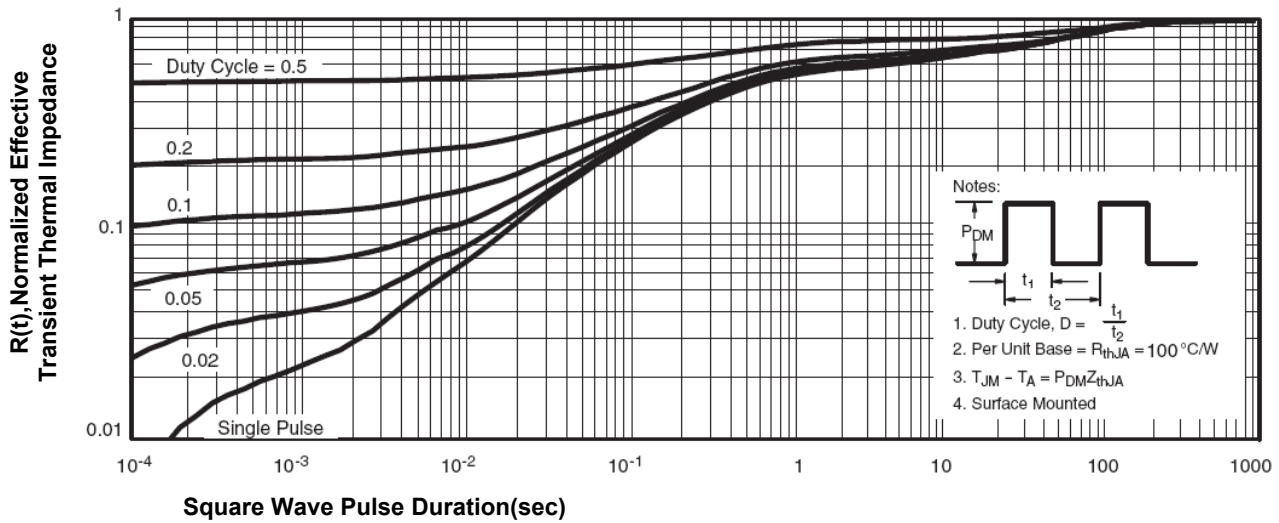
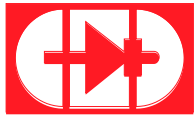
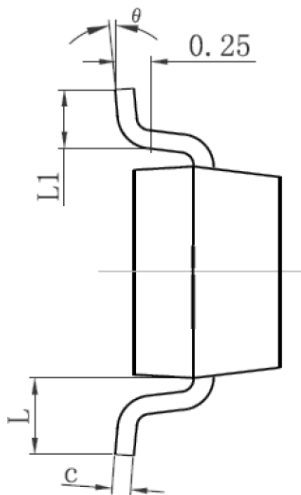
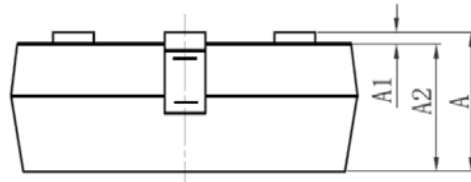
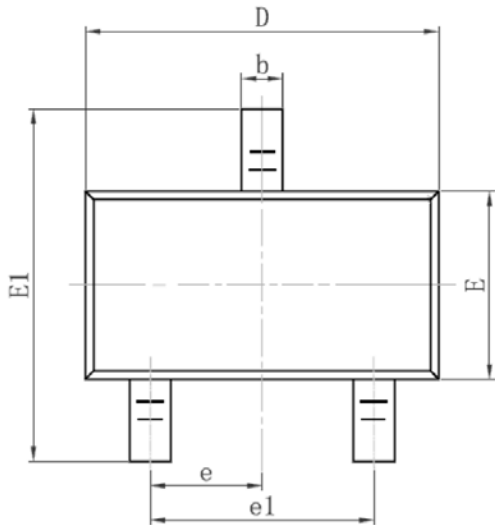

Figure 14. Normalized Maximum Transient Thermal Impedance



Package Outline Dimensions (SOT-23)



Symbol	Dimensions in Millimeters	
	MIN.	MAX.
A	0.900	1.150
A1	0.000	0.100
A2	0.900	1.050
b	0.300	0.500
c	0.080	0.150
D	2.800	3.000
E	1.200	1.400
E1	2.250	2.550
e	0.950TYP	
e1	1.800	2.000
L	0.550REF	
L1	0.300	0.500
θ	0°	8°

NOTES

1. All dimensions are in millimeters.
2. Tolerance $\pm 0.10\text{mm}$ (4 mil) unless otherwise specified
3. Package body sizes exclude mold flash and gate burrs. Mold flash at the non-lead sides should be less than 5 mils.
4. Dimension L is measured in gauge plane.
5. Controlling dimension is millimeter, converted inch dimensions are not necessarily exact.