

---

**ST-LINK/V2 in-circuit debugger/programmer  
for STM8 and STM32**

---

**Introduction**

The ST-LINK/V2 is an in-circuit debugger/programmer for the STM8 and STM32 microcontrollers. The single wire interface module (SWIM) and the JTAG/serial wire debugging (SWD) interfaces facilitate the communication with any STM8 or STM32 microcontroller operating on an application board.

In addition to providing the same functionalities of the ST-LINK/V2, the ST-LINK/V2-ISOL features digital isolation between the PC and the target application board. It also withstands voltages of up to 1000 V<sub>RMS</sub>.

The USB full-speed interface enables communication with a PC and:

- STM8 devices via ST Visual Develop (STVD) or ST Visual Program (STVP) software (available from STMicroelectronics)
- STM32 devices via Atollic<sup>®</sup>, IAR<sup>™</sup>, Keil<sup>®</sup> and TASKING<sup>®</sup> integrated development environments.

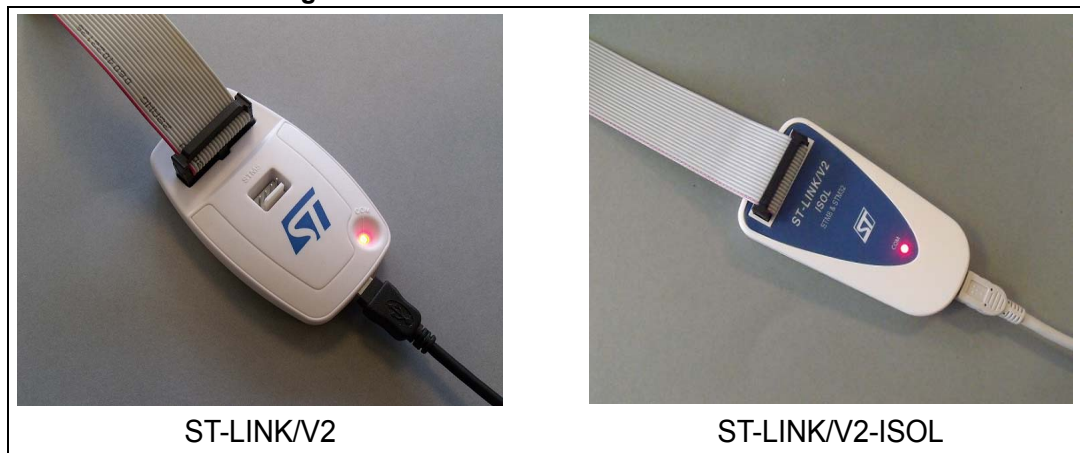
**Figure 1. ST-LINK/V2 and ST-LINK/V2-ISOL**

# Contents

- 1        Features ..... 5**
- 2        Ordering information ..... 5**
- 3        Product contents ..... 6**
- 4        Hardware configuration ..... 8**
  - 4.1    Connection with STM8 ..... 9
    - 4.1.1    Standard ERNI connection with SWIM flat ribbon ..... 9
    - 4.1.2    Low-cost SWIM connection ..... 10
    - 4.1.3    SWIM signals and connections ..... 10
  - 4.2    Connection with STM32 ..... 12
  - 4.3    ST-LINK/V2 status LED ..... 14
- 5        Software configuration ..... 15**
  - 5.1    ST-LINK/V2 firmware upgrade ..... 15
  - 5.2    STM8 application development ..... 15
  - 5.3    STM32 application development and Flash programming ..... 15
- 6        Schematics ..... 16**
- 7        Revision history ..... 18**

## List of tables

Table 1.	List of the order codes . . . . .	5
Table 2.	SWIM flat ribbon connections for ST-LINK/V2 . . . . .	11
Table 3.	SWIM low-cost cable connections for ST-LINK/V2-ISOL . . . . .	11
Table 4.	JTAG/SWD cable connections . . . . .	12
Table 5.	How third-party toolchains support ST-LINK/V2 . . . . .	15
Table 6.	Document revision history . . . . .	18

## List of figures

Figure 1.	ST-LINK/V2 and ST-LINK/V2-ISOL . . . . .	1
Figure 2.	ST-LINK/V2 product contents . . . . .	6
Figure 3.	ST-LINK/V2-ISOL product contents . . . . .	7
Figure 4.	Connectors of the ST-LINK/V2 (on the left) and of the ST-LINK/V2-ISOL (on the right) . . .	8
Figure 5.	ERNI connection . . . . .	9
Figure 6.	Key detail on connectors . . . . .	10
Figure 7.	Low-cost connection . . . . .	10
Figure 8.	Target SWIM connector . . . . .	11
Figure 9.	JTAG and SWD connection . . . . .	13
Figure 10.	JTAG debugging flat ribbon layout . . . . .	13
Figure 11.	SWIM ST-LINK/V2 standard ERNI cable . . . . .	16
Figure 12.	SWIM ST-LINK/V2 low-cost cable . . . . .	17

## 1 Features

- 5 V power supplied by a USB connector
- USB 2.0 full speed compatible interface
- USB standard A to Mini-B cable
- SWIM specific features
  - 1.65 V to 5.5 V application voltage supported on SWIM interface
  - SWIM low-speed and high-speed modes supported
  - SWIM programming-speed rate: 9.7 Kbytes/s in low speed and 12.8 Kbytes/s in high speed
  - SWIM cable for connection to the application via an ERNI standard vertical (ref: 284697 or 214017) or horizontal (ref: 214012) connector
  - SWIM cable for connection to the application via a pin header or a 2.54 mm pitch connector
- JTAG/serial wire debugging (SWD) specific features
  - 1.65 V to 3.6 V application voltage supported on the JTAG/SWD interface and 5 V tolerant inputs
  - JTAG cable for connection to a standard JTAG 20-pin pitch 2.54 mm connector
  - Supports JTAG communication
  - Supports serial wire debug (SWD) and serial wire viewer (SWV) communication
- Direct firmware update feature supported (DFU)
- Status LED, which blinks during communication with the PC
- 1000 V<sub>RMS</sub> high isolation voltage (ST-LINK/V2-ISOL only)
- Operating temperature from 0 to 50 °C

## 2 Ordering information

To order the ST-LINK/V2 refer to [Table 1](#).

**Table 1. List of the order codes**

Order code	ST-LINK description
ST-LINK/V2	In-circuit debugger/programmer
ST-LINK/V2-ISOL	In-circuit debugger/programmer with digital isolation

### 3 Product contents

The cables delivered within the product are shown in [Figure 2](#) and [Figure 3](#). They include (from left to right):

- USB standard A to Mini-B cable (A)
- ST-LINK/V2 debugging and programming (B)
- SWIM low-cost connector (C)
- SWIM flat ribbon with a standard ERNI connector at one end (D)
- JTAG or SWD and SWV flat ribbon with a 20-pin connector (E)

**Figure 2. ST-LINK/V2 product contents**



Figure 3. ST-LINK/V2-ISOL product contents



## 4 Hardware configuration

The ST-LINK/V2 is designed around the STM32F103C8 device, which incorporates the high-performance Arm<sup>®(a)</sup> Cortex<sup>®</sup>-M3 core. It is available in a TQFP48 package.

As shown in [Figure 4](#), the ST-LINK/V2 provides two connectors:

- an STM32 connector for the JTAG/SWD and SWV interface
- an STM8 connector for the SWIM interface

The ST-LINK/V2-ISOL provides one connector for the STM8 SWIM, STM32 JTAG/SWD and SWV interfaces.

**Figure 4. Connectors of the ST-LINK/V2 (on the left) and of the ST-LINK/V2-ISOL (on the right)**



1. A = STM32 JTAG and SWD target connector
2. B = STM8 SWIM target connector
3. C = STM8 SWIM, STM32 JTAG and SWD target connector
4. D = Communication activity LED

arm

a. Arm is a registered trademark of Arm Limited (or its subsidiaries) in the US and/or elsewhere.



## 4.1 Connection with STM8

For development of applications based on STM8 microcontrollers, the ST-LINK/V2 can be connected to the target board by two different cables, depending on the connector available on the application board.

These cables are:

- SWIM flat ribbon with a standard ERNI connector at one end
- SWIM cable with two 4-pin, 2.54 mm connector or SWIM separate-wires cable

### 4.1.1 Standard ERNI connection with SWIM flat ribbon

*Figure 5* shows how to connect the ST-LINK/V2 if a standard ERNI 4-pin SWIM connector is present on the application board.

**Figure 5. ERNI connection**

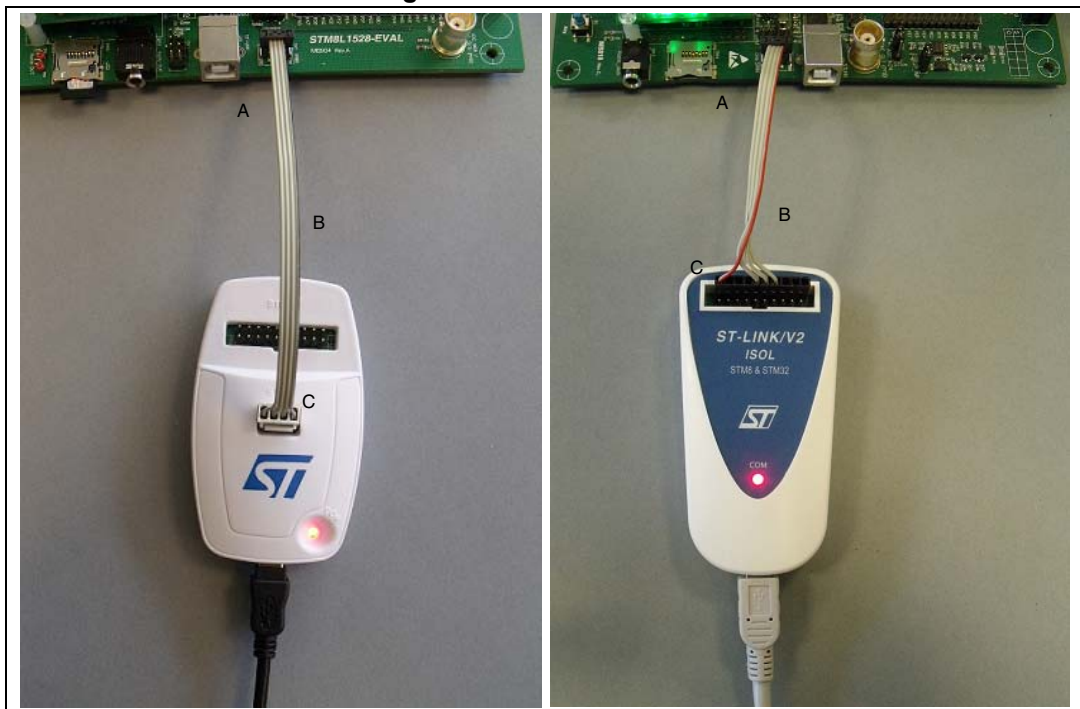

1. A = Target application board with ERNI connector
2. B = Wire cable with ERNI connector at one end
3. C = STM8 SWIM target connector
4. See [Figure 11](#)

*Figure 6* shows that pin 16 is missing on the ST-LINK/V2-ISOL target connector. This missing pin is used as a safety key on the cable connector, to guarantee connection of the SWIM cable in the correct position on the target connector even pins, used for both SWIM and JTAG cables.

Figure 6. Key detail on connectors

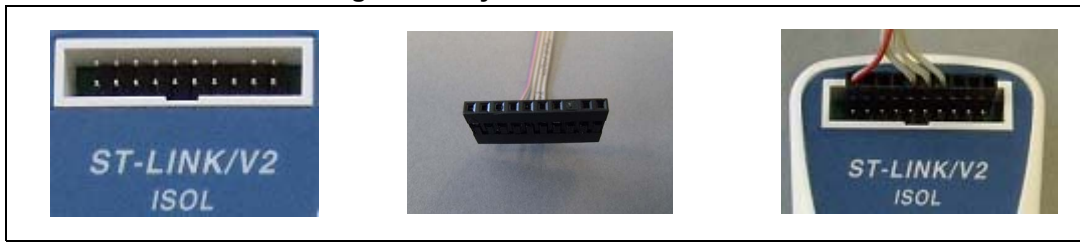

### 4.1.2 Low-cost SWIM connection

Figure 7 shows how to connect the ST-LINK/V2 if a 4-pin, 2.54 mm, low-cost SWIM connector is present on the application board.

Figure 7. Low-cost connection

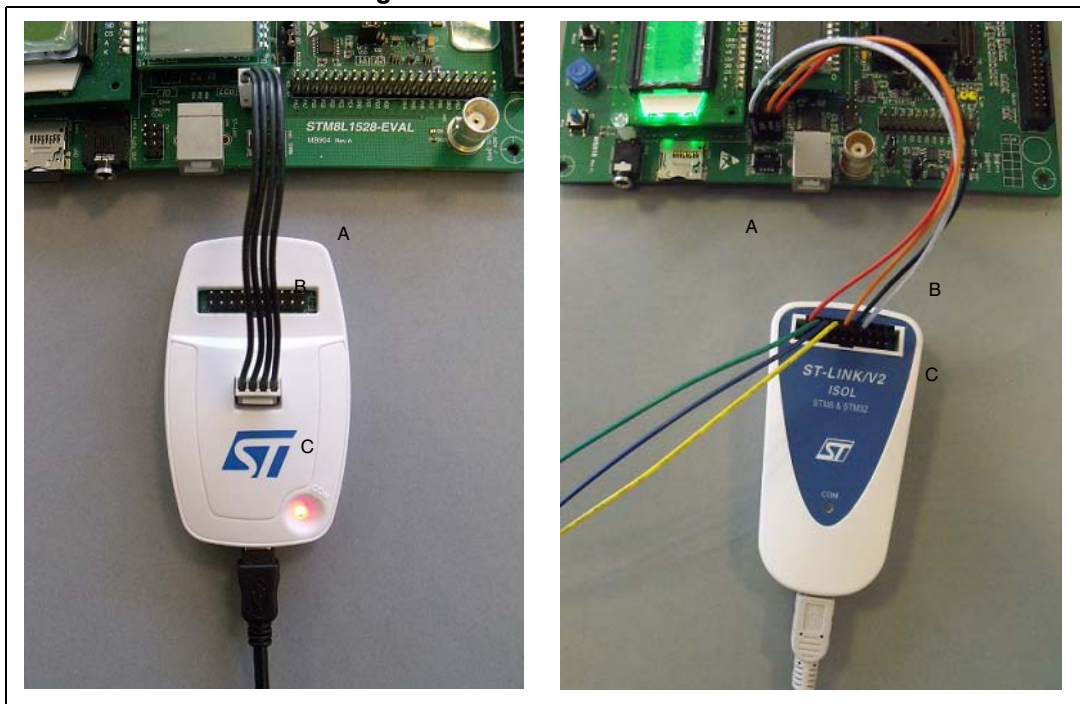

- 1. A = Target application board with 4-pin, 2.54 mm, low-cost connector
- 2. B = Wire cable with a 4-pin connector or separate-wires cable
- 3. C = STM8 SWIM target connector
- 4. See [Figure 12](#)

### 4.1.3 SWIM signals and connections

Table 2 summarizes the signal names, functions, and target connection signals using the wire cable with a 4-pin connector.

**Table 2. SWIM flat ribbon connections for ST-LINK/V2**

Pin no.	Name	Function	Target connection
1	VDD	Target VCC <sup>(1)</sup>	MCU VCC
2	DATA	SWIM	MCU SWIM pin
3	GND	GROUND	GND
4	RESET	RESET	MCU RESET pin

1. The power supply from the application board is connected to the ST-LINK/V2 debugging and programming board to ensure signal compatibility between both boards.

**Figure 8. Target SWIM connector**

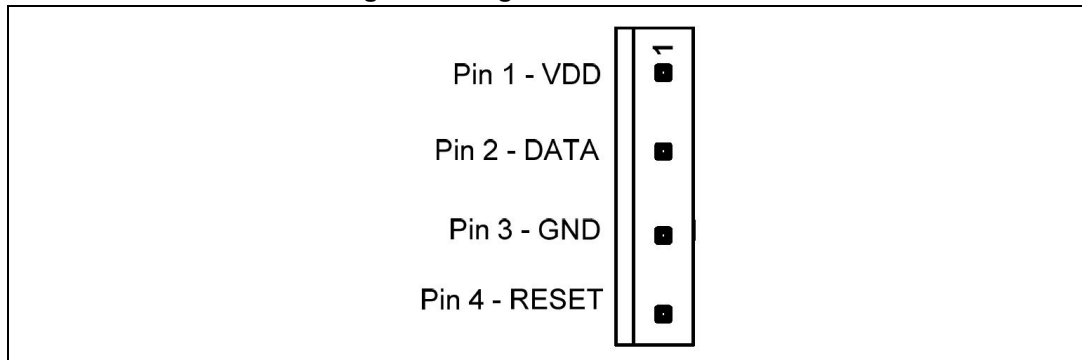

**Table 3** summarizes the signal names, functions, and target connection signals using the separate-wires cable.

As the SWIM separate-wires cable has independent connectors for all pins on one side, it is possible to connect the ST-LINK/V2-ISOL to an application board without a standard SWIM connector. On this flat ribbon, all signals are referenced by a specific color and a label to ease the connection on target.

**Table 3. SWIM low-cost cable connections for ST-LINK/V2-ISOL**

Color	Cable pin name	Function	Target connection
Red	TVCC	Target VCC <sup>(1)</sup>	MCU VCC
Green	UART-RX	Unused	Reserved <sup>(2)</sup> (not connected on the target board)
Blue	UART-TX		
Yellow	BOOT0		
Orange	SWIM	SWIM	MCU SWIM pin
Black	GND	GROUND	GND
White	SWIM-RST	RESET	MCU RESET pin

1. The power supply from the application board is connected to the ST-LINK/V2 debugging and programming board to ensure signal compatibility between both boards.

2. BOOT0, UART-TX and UART-RX are reserved for future developments.

TVCC, SWIM, GND and SWIM-RST can be connected to a low-cost 2.54 mm pitch connector or to pin headers available on the target board.

## 4.2 Connection with STM32

For development of applications based on STM32 microcontrollers the ST-LINK/V2 needs to be connected to the application using the standard 20-pin JTAG flat ribbon provided.

[Table 4](#) summarizes the signals names, functions, and target connection signals of the standard 20-pin JTAG flat ribbon.

**Table 4. JTAG/SWD cable connections**

Pin no.	ST-LINK/V2 connector (CN3)	ST-LINK/V2 function	Target connection (JTAG)	Target connection (SWD)
1	VAPP	Target VCC	MCU VDD <sup>(1)</sup>	MCU VDD <sup>(1)</sup>
2				
3	TRST	JTAG TRST	JNTRST	GND <sup>(2)</sup>
4	GND <sup>(3)</sup>	GND <sup>(3)</sup>	GND <sup>(3)(4)</sup>	GND <sup>(3)(4)</sup>
5	TDI	JTAG TDO	JTDI	GND <sup>(2)</sup>
6	GND <sup>(3)</sup>	GND <sup>(3)</sup>	GND <sup>(3)(4)</sup>	GND <sup>(3)(4)</sup>
7	TMS_SWDIO	JTAG TMS, SW IO	JTMS	SWDIO
8	GND <sup>(3)</sup>	GND <sup>(3)</sup>	GND <sup>(3)(4)</sup>	GND <sup>(3)(4)</sup>
9	TCK_SWCLK	JTAG TCK, SW CLK	JTCK	SWCLK
10	GND <sup>(5)</sup>	GND <sup>(5)</sup>	GND <sup>(4)(5)</sup>	GND <sup>(4)(5)</sup>
11	Not connected	Not connected	Not connected	Not connected
12	GND	GND	GND <sup>(4)</sup>	GND <sup>(4)</sup>
13	TDO_SWO	JTAG TDI, SWO	JTDO	TRACESWO <sup>(6)</sup>
14	GND <sup>(5)</sup>	GND <sup>(5)</sup>	GND <sup>(4)(5)</sup>	GND <sup>(4)(5)</sup>
15	NRST	NRST	NRST	NRST
16	GND <sup>(3)</sup>	GND <sup>(3)</sup>	GND <sup>(3)(4)</sup>	GND <sup>(3)(4)</sup>
17	Not connected	Not connected	Not connected	Not connected
18	GND	GND	GND <sup>(4)</sup>	GND <sup>(4)</sup>
19	VDD <sup>(3)</sup>	VDD (3.3 V) <sup>(3)</sup>	Not connected	Not connected
20	GND	GND	GND <sup>(4)</sup>	GND <sup>(4)</sup>

1. The power supply from the application board is connected to the ST-LINK/V2 debugging and programming board to ensure signal compatibility between the boards.
2. Connect to GND for noise reduction on the ribbon.
3. Available on ST-LINK/V2 only, not connected on ST-LINK/V2-ISOL.
4. At least one of this pin must be connected to the ground for correct behavior (connecting all of them is recommended).
5. GND on ST-LINK/V2, used by SWIM on ST-LINK/V2-ISOL (see [Table 3](#)).
6. Optional: for Serial Wire Viewer (SWV) trace.

Figure 9 shows how to connect the ST-LINK/V2 to a target using the JTAG cable.

Figure 9. JTAG and SWD connection

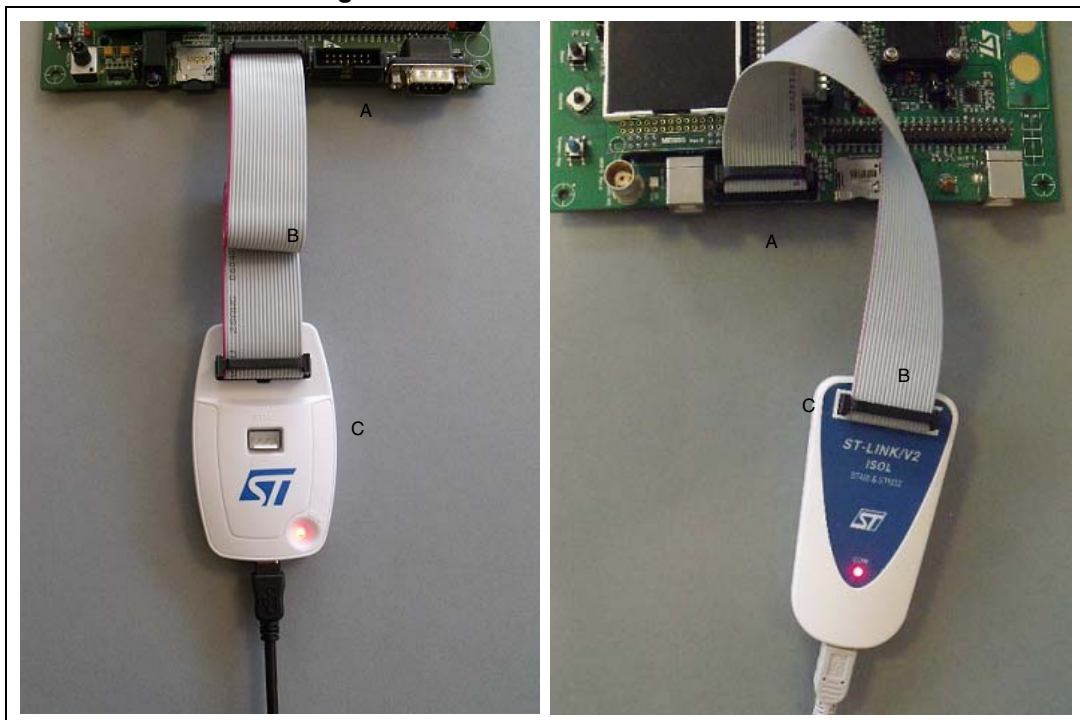

1. A = Target application board with JTAG connector
2. B = JTAG/SWD 20-wire flat cable
3. C= STM32 JTAG and SWD target connector

The reference of the connector needed on the target application board is:  
 2x10C header wrapping 2x40C H3/9.5 (pitch 2.54) - HED20 SCOTT PHSD80.

Figure 10. JTAG debugging flat ribbon layout

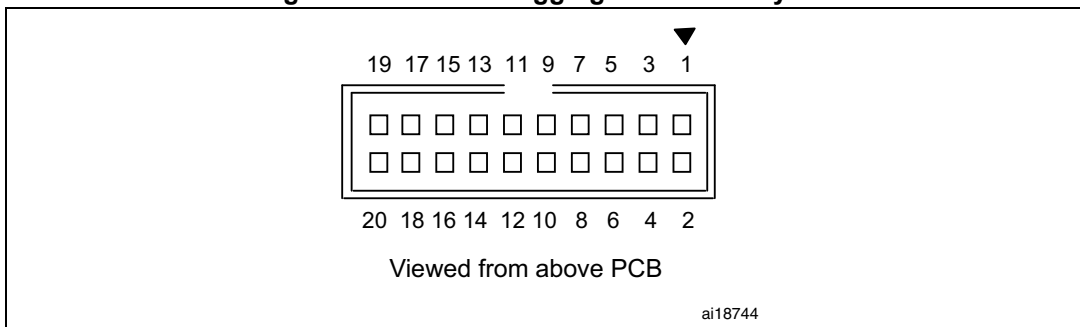

**Note:** For low cost applications or when the standard 20-pin 2.54mm-pitch connector footprint is too big, it is possible to implement the Tag-Connect solution to save cost and space on the application board. The Tag-Connect adapter and cable provide a simple and reliable means of connecting ST-LINK/V2 or ST-LINK/V2-ISOL to the PCB without requiring a mating component on the application PCB.

*For more details on this solution and application-PCB-footprint information, visit [www.tag-connect.com](http://www.tag-connect.com).*

*The references of components compatible with JTAG and SWD interfaces are:*

- a) TC2050-ARM2010 adapter (20-pin- to 10-pin-interface board)*
- b) TC2050-IDC or TC2050-IDC-NL (No Legs) (10-pin cable)*
- c) TC2050-CLIP retaining clip for use with TC2050-IDC-NL (optional)*

### 4.3 ST-LINK/V2 status LED

The LED labeled 'COM' on top of the ST-LINK/V2 shows the ST-LINK/V2 status (whatever the connection type). In detail:

- LED is blinking RED: the first USB enumeration with the PC is taking place
- LED is RED: communication between the PC and ST-LINK/V2 is established (end of enumeration)
- LED is blinking GREEN / RED: data being exchanged between the target and the PC
- LED is GREEN: the last communication has been successful
- LED is ORANGE: ST-LINK/V2 communication with the target has failed.

## 5 Software configuration

### 5.1 ST-LINK/V2 firmware upgrade

The ST-LINK/V2 embeds a firmware upgrade mechanism for *in-situ* upgrade through the USB port. As the firmware can evolve during the life of the ST-LINK/V2 product (new functionality, bug fixes, support for new microcontroller families ...), it is recommended to periodically visit the dedicated pages on [www.st.com](http://www.st.com) to stay up-to-date with the latest firmware version.

### 5.2 STM8 application development

Refer to ST toolset Pack24 with Patch 1 or more recent, which includes ST Visual Develop (STVD) and ST Visual Programmer (STVP).

### 5.3 STM32 application development and Flash programming

Third-party toolchains, Atollic® TrueSTUDIO®, IAR™ EWARM, Keil® MDK-ARM™, and TASKING® VX-toolset support ST-LINK/V2 according to the versions given in [Table 5](#) or in the most recent version available.

**Table 5. How third-party toolchains support ST-LINK/V2**

Third party	Toolchain	Version
Atollic®	TrueSTUDIO®	2.1
IAR™	EWARM	6.20
Keil®	MDK-ARM™	4.20
TASKING®	VX-toolset for Arm® Cortex®-M	4.0.1

The ST-LINK/V2 requires a dedicated USB driver. If the toolset installed it automatically, the file *stlink\_winusb.inf* is installed in <WINDIR>/inf (where <WINDIR> is typically C:/Windows).

If the toolset setup does not install it automatically, the driver can be found on [www.st.com](http://www.st.com):

1. Connect to [www.st.com](http://www.st.com).
2. In the search tab, part number field, look for **ST-LINK/V2**.
3. Click on the **Generic Part Number** column hyperlink to ST-LINK/V2.
4. In the **Design support** tab, **SW drivers** section, click on the icon to download *st-link\_v2\_usbdriver.zip*.
5. Unzip and run *ST-Link\_V2\_USBdriver.exe*.

For more information on third-party tools, visit the following websites:

- [www.atollic.com](http://www.atollic.com)
- [www.iar.com](http://www.iar.com)
- [www.keil.com](http://www.keil.com)
- [www.tasking.com](http://www.tasking.com)

# 6 Schematics

Figure 11. SWIM ST-LINK/V2 standard ERNI cable

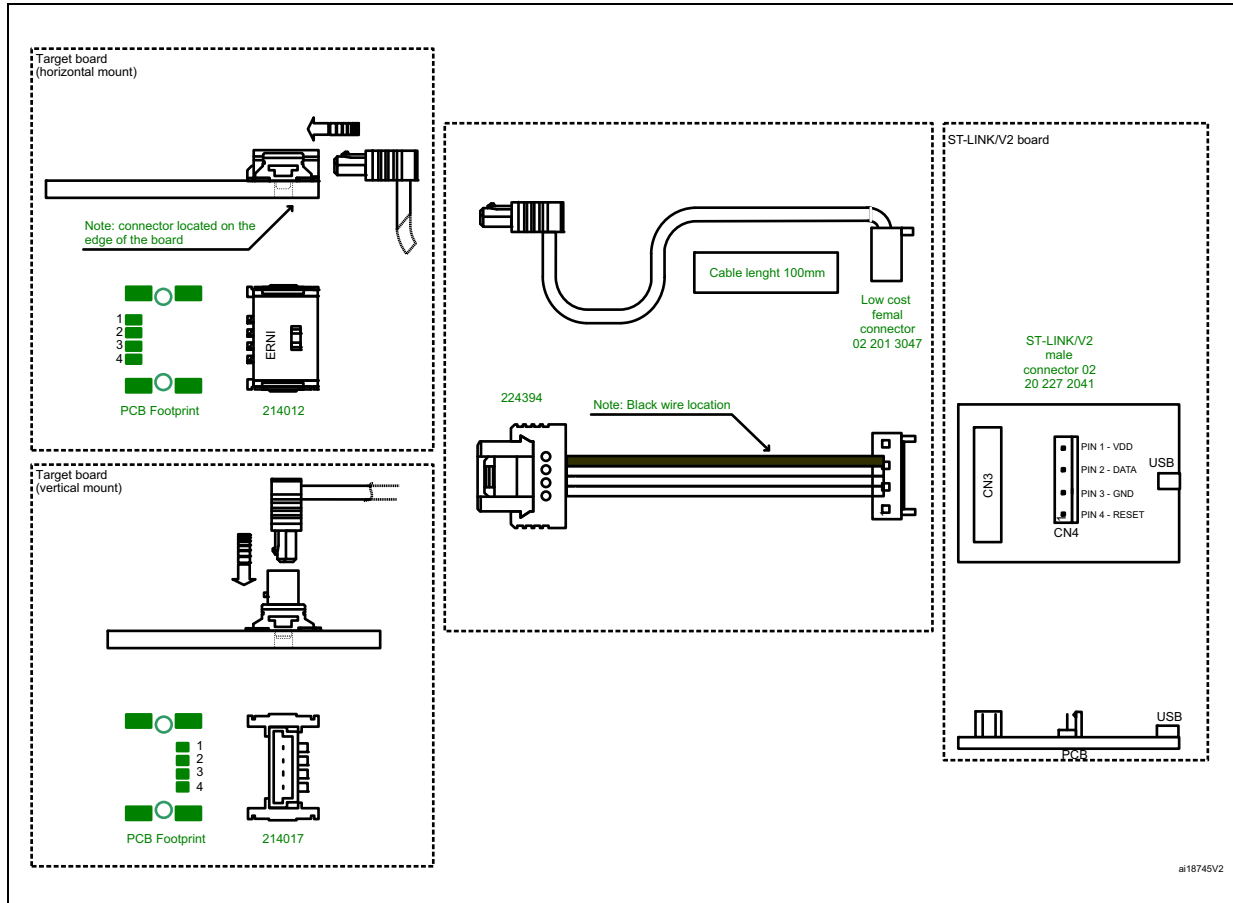

- Legend for pin descriptions:  
 VDD = Target voltage sense  
 DATA = SWIM DATA line between target and debug tool  
 GND = Ground voltage  
 RESET = Target system reset



Figure 12. SWIM ST-LINK/V2 low-cost cable

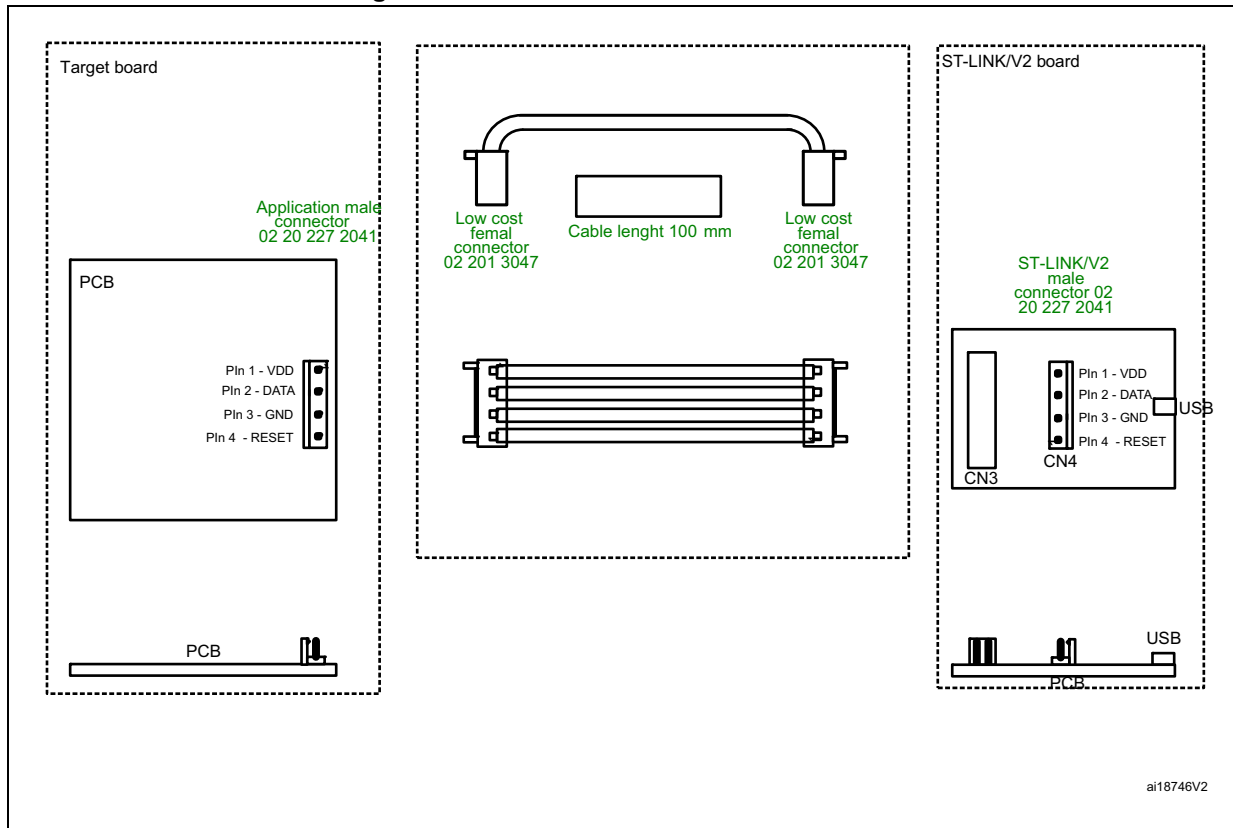

- Legend for pin descriptions:  
 VDD = Target voltage sense  
 DATA = SWIM DATA line between target and debug tool  
 GND = Ground voltage  
 RESET = Target system reset

## 7 Revision history

**Table 6. Document revision history**

Date	Revision	Changes
22-Apr-2011	1	Initial release.
03-Jun-2011	2	<p><a href="#">Table 2: SWIM flat ribbon connections for ST-LINK/V2</a>: added footnote <a href="#">1</a> to the function “Target VCC”.</p> <p><a href="#">Table 4: JTAG/SWD cable connections</a>: added footnote to the function “Target VCC”.</p> <p><a href="#">Table 5: How third-party toolchains support ST-LINK/V2</a>: updated the “Versions” of IAR and Keil.</p>
19-Aug-2011	3	Added USB driver details to <a href="#">Section 5.3</a> .
11-May-2012	4	Added SWD and SWV to JTAG connection features. Modified <a href="#">Table 4: JTAG/SWD cable connections</a> .
13-Sep-2012	5	<p>Added ST-LINK/V2-ISOL order code.</p> <p>Updated <a href="#">Section 4.1: STM8 application development on page 15</a>.</p> <p>Added Note <a href="#">6</a> in <a href="#">Table 4</a>.</p> <p>Added Note “For low cost applications...” before <a href="#">Section 3.3: ST-LINK/V2 status LEDs on page 14</a>.</p>
18-Oct-2012	6	Added <a href="#">Section 5.1: ST-LINK/V2 firmware upgrade on page 15</a> .
25-Mar-2016	7	Updated $V_{RMS}$ value in <a href="#">Introduction</a> and in <a href="#">Features</a> .
18-Oct-2018	8	Updated <a href="#">Table 4: JTAG/SWD cable connections</a> and its footnotes. Minor text edits across the whole document.

**IMPORTANT NOTICE – PLEASE READ CAREFULLY**

STMicroelectronics NV and its subsidiaries ("ST") reserve the right to make changes, corrections, enhancements, modifications, and improvements to ST products and/or to this document at any time without notice. Purchasers should obtain the latest relevant information on ST products before placing orders. ST products are sold pursuant to ST's terms and conditions of sale in place at the time of order acknowledgement.

Purchasers are solely responsible for the choice, selection, and use of ST products and ST assumes no liability for application assistance or the design of Purchasers' products.

No license, express or implied, to any intellectual property right is granted by ST herein.

Resale of ST products with provisions different from the information set forth herein shall void any warranty granted by ST for such product.

ST and the ST logo are trademarks of ST. All other product or service names are the property of their respective owners.

Information in this document supersedes and replaces information previously supplied in any prior versions of this document.

© 2018 STMicroelectronics – All rights reserved