

## LMH6622 Dual Wideband, Low Noise, 160 MHz, Operational Amplifiers

### 1 Features

- $V_S = \pm 6\text{ V}$ ,  $T_A = 25^\circ\text{C}$ , Typical Values Unless Specified
- Bandwidth ( $A_V = +2$ ) 160 MHz
- Supply Voltage Range  $\pm 2.5\text{ V}$  to  $\pm 6\text{ V}$ ;  $+5\text{ V}$  to  $+12\text{ V}$
- Slew Rate  $85\text{ V}/\mu\text{s}$
- Supply Current  $4.3\text{ mA}/\text{amp}$
- Input Common Mode Voltage  $-4.75\text{ V}$  to  $+5.7\text{ V}$
- Output Voltage Swing ( $R_L = 100\ \Omega$ )  $\pm 4.6\text{ V}$
- Input Voltage Noise  $1.6\text{ nV}/\sqrt{\text{Hz}}$
- Input Current Noise  $1.5\text{ pA}/\sqrt{\text{Hz}}$
- Linear Output Current  $90\text{ mA}$
- Excellent Harmonic Distortion  $90\text{ dBc}$

### 2 Applications

- xDSL Receiver
- Low Noise Instrumentation Front End
- Ultrasound Preamp
- Active Filters
- Cellphone Basestation

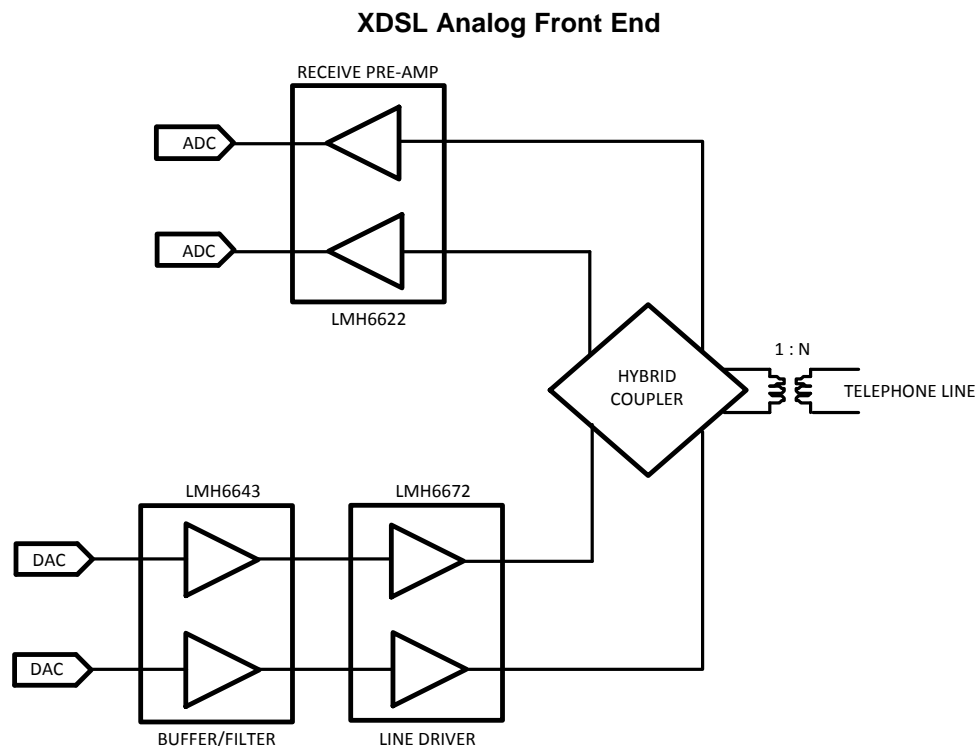
### 3 Description

The LMH6622 is a dual high speed voltage feedback operational amplifier specifically optimized for low noise. A voltage noise specification of  $1.6\text{ nV}/\sqrt{\text{Hz}}$ , a current noise specification  $1.5\text{ pA}/\sqrt{\text{Hz}}$ , a bandwidth of 160 MHz, and a harmonic distortion specification that exceeds 90 dBc combine to make the LMH6622 an ideal choice for the receive channel amplifier in ADSL, VDSL, or other xDSL designs. The LMH6622 operates from  $\pm 2.5\text{ V}$  to  $\pm 6\text{ V}$  in dual supply mode and from  $+5\text{ V}$  to  $+12\text{ V}$  in single supply configuration. The LMH6622 is stable for  $A_V \geq 2$  or  $A_V \leq -1$ . The fabrication of the LMH6622 on TI's advanced VIP10 process enables excellent (160 MHz) bandwidth at a current consumption of only  $4.3\text{ mA}/\text{amplifier}$ . Packages for this dual amplifier are the 8-lead SOIC and the 8-lead VSSOP.

#### Device Information<sup>(1)</sup>

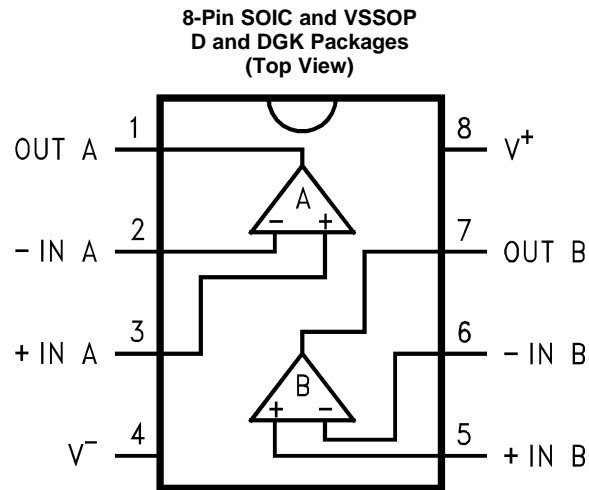
PART NUMBER	PACKAGE	BODY SIZE (NOM)
LMH6622	SOIC (8)	4.90 mm x 3.91 mm
LMH6622	VSSOP (8)	3.00 mm x 3.00 mm

(1) For all available packages, see the orderable addendum at the end of the datasheet.





## 5 Pin Configuration and Functions



**Pin Functions**

PIN		I/O	DESCRIPTION
NAME	NO.		
OUT A	1	O	ChA Output
-IN A	2	I	ChA Inverting Input
+IN A	3	I	ChA Non-inverting Input
V-	4	I	V- Supply Pin
+IN B	5	I	ChB Non-inverting Input
-IN B	6	I	ChB Inverting Input
OUT B	7	I	ChB Output
V+	8	I	V+ Supply Pin

## 6 Specifications

### 6.1 Absolute Maximum Ratings<sup>(1)(2)</sup>

	MIN	MAX	UNIT
V <sub>IN</sub> Differential		±1.2	V
Supply Voltage (V <sup>+</sup> – V <sup>-</sup> )		13.2	V
Voltage at Input Pins		V <sup>+</sup> +0.5, V <sup>-</sup> -0.5	V
<b>SOLDERING INFORMATION</b>			
Infrared or Convection (20 sec)		235	°C
Wave Soldering (10 sec)		260	°C
Junction Temperature <sup>(3)</sup>		+150	°C

- (1) Absolute Maximum Ratings indicate limits beyond which damage to the device may occur. Operating Ratings indicate conditions for which the device is intended to be functional, but specific performance is not ensured. For ensured specifications and the test conditions, see the Electrical Characteristics.
- (2) If Military/Aerospace specified devices are required, please contact the Texas Instruments Sales Office/Distributors for availability and specifications.
- (3) The maximum power dissipation is a function of T<sub>J(MAX)</sub>, R<sub>θJA</sub> and T<sub>A</sub>. The maximum allowable power dissipation at any ambient temperature is P<sub>D</sub> = (T<sub>J(MAX)</sub> – T<sub>A</sub>)/R<sub>θJA</sub>. All numbers apply for packages soldered directly onto a PC board.

### 6.2 Handling Ratings

	MIN	MAX	UNIT
T <sub>stg</sub> Storage temperature range	-65°	+150	°C
V <sub>(ESD)</sub> Electrostatic discharge	Human body model (HBM), per ANSI/ESDA/JEDEC JS-001, all pins <sup>(1)</sup>	2000 <sup>(2)</sup>	V
	Charged device model (CDM), per JEDEC specification JESD22-C101, all pins <sup>(3)</sup>	200 <sup>(2)</sup>	

- (1) JEDEC document JEP155 states that 2000-V HBM allows safe manufacturing with a standard ESD control process.
- (2) Human body model, 1.5 kΩ in series with 100 pF. Machine model, 0 Ω in series with 200 pF.
- (3) JEDEC document JEP157 states that 200-V CDM allows safe manufacturing with a standard ESD control process.

### 6.3 Recommended Operating Conditions<sup>(1)</sup>

	MIN	MAX	UNIT
Supply Voltage (V <sup>+</sup> – V <sup>-</sup> )	±2.25	±6	V
Temperature Range <sup>(2)(3)</sup>	-40	+85	°C

- (1) Absolute Maximum Ratings indicate limits beyond which damage to the device may occur. Operating Ratings indicate conditions for which the device is intended to be functional, but specific performance is not ensured. For ensured specifications and the test conditions, see the Electrical Characteristics.
- (2) Applies to both single-supply and split-supply operation. Continuous short circuit operation at elevated ambient temperature can result in exceeding the maximum allowed junction temperature of 150°C.
- (3) The maximum power dissipation is a function of T<sub>J(MAX)</sub>, R<sub>θJA</sub> and T<sub>A</sub>. The maximum allowable power dissipation at any ambient temperature is P<sub>D</sub> = (T<sub>J(MAX)</sub> – T<sub>A</sub>)/R<sub>θJA</sub>. All numbers apply for packages soldered directly onto a PC board.

### 6.4 Thermal Information

THERMAL METRIC <sup>(1)</sup>	LMH6622	LMH6622	UNIT
	Package D	Package DGK	
	8 PINS	8 PINS	
R <sub>θJA</sub> Junction-to-ambient thermal resistance <sup>(2)</sup>	166°	211°	°C/W

- (1) For more information about traditional and new thermal metrics, see the *IC Package Thermal Metrics* application report, [SPRA953](#).
- (2) The maximum power dissipation is a function of T<sub>J(MAX)</sub>, R<sub>θJA</sub> and T<sub>A</sub>. The maximum allowable power dissipation at any ambient temperature is P<sub>D</sub> = (T<sub>J(MAX)</sub> – T<sub>A</sub>)/R<sub>θJA</sub>. All numbers apply for packages soldered directly onto a PC board.

## 6.5 ±6 V Electrical Characteristics

Unless otherwise specified,  $T_J = 25^\circ\text{C}$ ,  $V^+ = 6\text{ V}$ ,  $V^- = -6\text{ V}$ ,  $V_{\text{CM}} = 0\text{ V}$ ,  $A_V = +2$ ,  $R_F = 500\ \Omega$ ,  $R_L = 100\ \Omega$ . Some limits apply at the temperature extremes as noted in the table.

PARAMETER	TEST CONDITIONS	TEMPERATURE EXTREMES			ROOM TEMPERATURE			UNIT
		MIN <sup>(1)</sup>	TYP <sup>(2)</sup>	MAX <sup>(1)</sup>	MIN <sup>(1)</sup>	TYP <sup>(2)</sup>	MAX <sup>(1)</sup>	
<b>DYNAMIC PERFORMANCE</b>								
$f_{\text{CL}}$	-3dB BW	$V_O = 200\text{ mV}_{\text{PP}}$					160	MHz
$\text{BW}_{0.1\text{dB}}$	0.1dB Gain Flatness	$V_O = 20\text{ mV}_{\text{PP}}$					30	MHz
SR	Slew Rate <sup>(3)</sup>	$V_O = 2\text{ V}_{\text{PP}}$					85	V/ $\mu\text{s}$
TS	Settling Time	$V_O = 2\text{ V}_{\text{PP}}$ to $\pm 0.1\%$					40	ns
		$V_O = 2\text{ V}_{\text{PP}}$ to $\pm 1.0\%$					35	
Tr	Rise Time	$V_O = 0.2\text{ V}$ Step, 10% to 90%					2.3	ns
Tf	Fall Time	$V_O = 0.2\text{ V}$ Step, 10% to 90%					2.3	ns
<b>DISTORTION and NOISE RESPONSE</b>								
$e_n$	Input Referred Voltage Noise	$f = 100\text{ kHz}$					1.6	nV/ $\sqrt{\text{Hz}}$
$i_n$	Input Referred Current Noise	$f = 100\text{ kHz}$					1.5	pA/ $\sqrt{\text{Hz}}$
DG	Differential Gain	$R_L = 150\ \Omega$ , $R_F = 470\ \Omega$ , NTSC					0.03%	
DP	Differential Phase	$R_L = 150\ \Omega$ , $R_F = 470\ \Omega$ , NTSC					0.03	deg
HD2	2 <sup>nd</sup> Harmonic Distortion	$f_c = 1\text{ MHz}$ , $V_O = 2\text{ V}_{\text{PP}}$ , $R_L = 100\ \Omega$					-90	dBc
		$f_c = 1\text{ MHz}$ , $V_O = 2\text{ V}_{\text{PP}}$ , $R_L = 500\ \Omega$					-100	
HD3	3 <sup>rd</sup> Harmonic Distortion	$f_c = 1\text{ MHz}$ , $V_O = 2\text{ V}_{\text{PP}}$ , $R_L = 100\ \Omega$					-94	dBc
		$f_c = 1\text{ MHz}$ , $V_O = 2\text{ V}_{\text{PP}}$ , $R_L = 500\ \Omega$					-100	
MTPR	Upstream	$V_O = 0.6\text{ V}_{\text{RMS}}$ , 26 kHz to 132 kHz (see Figure 33)					-78	dBc
	Downstream	$V_O = 0.6\text{ V}_{\text{RMS}}$ , 144 kHz to 1.1 MHz (see Figure 33)					-70	
<b>INPUT CHARACTERISTICS</b>								
$V_{\text{OS}}$	Input Offset Voltage	$V_{\text{CM}} = 0\text{ V}$	-2	+2	-1.2	+0.2	+1.2	mV
TC $V_{\text{OS}}$	Input Offset Average Drift	$V_{\text{CM}} = 0\text{ V}$ <sup>(4)</sup>					-2.5	$\mu\text{V}/^\circ\text{C}$
$I_{\text{OS}}$	Input Offset Current	$V_{\text{CM}} = 0\text{ V}$	-1.5	1.5	-1	-0.04	1	$\mu\text{A}$
$I_B$	Input Bias Current	$V_{\text{CM}} = 0\text{ V}$		15		4.7	10	$\mu\text{A}$
$R_{\text{IN}}$	Input Resistance	Common Mode					17	M $\Omega$
		Differential Mode					12	k $\Omega$
$C_{\text{IN}}$	Input Capacitance	Common Mode					0.9	pF
		Differential Mode					1.0	pF
CMVR	Input Common Mode Voltage Range	CMRR $\geq 60\text{ dB}$					-4.75	-4.5
							5.5	+5.7
CMRR	Common-Mode Rejection Ratio	Input Referred, $V_{\text{CM}} = -4.2\text{ V}$ to $+5.2\text{ V}$	75				80	100

(1) All limits are specified by testing or statistical analysis.

(2) Typical values represent the most likely parametric norm.

(3) Slew rate is the slowest of the rising and falling slew rates.

(4) Offset voltage average drift is determined by dividing the change in  $V_{\text{OS}}$  at temperature extremes into the total temperature change.

## ±6 V Electrical Characteristics (continued)

Unless otherwise specified,  $T_J = 25^\circ\text{C}$ ,  $V^+ = 6\text{ V}$ ,  $V^- = -6\text{ V}$ ,  $V_{\text{CM}} = 0\text{ V}$ ,  $A_V = +2$ ,  $R_F = 500\ \Omega$ ,  $R_L = 100\ \Omega$ . Some limits apply at the temperature extremes as noted in the table.

PARAMETER	TEST CONDITIONS	TEMPERATURE EXTREMES			ROOM TEMPERATURE			UNIT		
		MIN <sup>(1)</sup>	TYP <sup>(2)</sup>	MAX <sup>(1)</sup>	MIN <sup>(1)</sup>	TYP <sup>(2)</sup>	MAX <sup>(1)</sup>			
<b>TRANSFER CHARACTERISTICS</b>										
$A_{\text{VOL}}$	Large Signal Voltage Gain	$V_O = 4\text{ V}_{\text{PP}}$	70			74	83		dB	
$X_t$	Crosstalk	$f = 1\text{ MHz}$				-75			dB	
<b>OUTPUT CHARACTERISTICS</b>										
$V_O$	Output Swing	No Load, Positive Swing	4.6			4.8	5.2		V	
		No Load, Negative Swing					-5.0			-4.6
		$R_L = 100\ \Omega$ , Positive Swing	3.8			4.0	4.6			
		$R_L = 100\ \Omega$ , Negative Swing					-4.6			-4
$R_O$	Output Impedance	$f = 1\text{ MHz}$				0.08			$\Omega$	
$I_{\text{SC}}$	Output Short Circuit Current	Sourcing to Ground $\Delta V_{\text{IN}} = 200\text{ mV}^{(5)}, (6)$				100	135		mA	
		Sinking to Ground $\Delta V_{\text{IN}} = -200\text{ mV}^{(5)}, (6)$				100	130			
$I_{\text{OUT}}$	Output Current	Sourcing, $V_O = +4.3\text{ V}$ Sinking, $V_O = -4.3\text{ V}$				90			mA	
<b>POWER SUPPLY</b>										
+PSRR	Positive Power Supply Rejection Ratio	Input Referred, $V_S = +5\text{ V to } +6\text{ V}$	74			80	95		dB	
-PSRR	Negative Power Supply Rejection Ratio	Input Referred, $V_S = -5\text{ V to } -6\text{ V}$	69			75	90			
$I_S$	Supply Current (per amplifier)	No Load				6.5	4.3	6	mA	

(5) Applies to both single-supply and split-supply operation. Continuous short circuit operation at elevated ambient temperature can result in exceeding the maximum allowed junction temperature of  $150^\circ\text{C}$ .

(6) Short circuit test is a momentary test. Output short circuit duration is infinite for  $V_S \leq \pm 2.5\text{ V}$ , at room temperature and below. For  $V_S > \pm 2.5\text{ V}$ , allowable short circuit duration is 1.5ms.

## 6.6 ±2.5 V Electrical Characteristics

Unless otherwise specified,  $T_J = 25^\circ\text{C}$ ,  $V^+ = 2.5\text{ V}$ ,  $V^- = -2.5\text{ V}$ ,  $V_{\text{CM}} = 0\text{ V}$ ,  $A_V = +2$ ,  $R_F = 500\ \Omega$ ,  $R_L = 100\ \Omega$ . Some limits apply at the temperature extremes as noted in the table.

PARAMETER	TEST CONDITIONS	TEMPERATURE EXTREMES			ROOM TEMPERATURE			UNIT	
		MIN <sup>(1)</sup>	TYP <sup>(2)</sup>	MAX <sup>(1)</sup>	MIN <sup>(1)</sup>	TYP <sup>(2)</sup>	MAX <sup>(1)</sup>		
<b>DYNAMIC PERFORMANCE</b>									
$f_{\text{CL}}$	-3 dB BW	$V_O = 200\text{ mV}_{\text{PP}}$				150			MHz
$\text{BW}_{0.1\text{dB}}$	0.1dB Gain Flatness	$V_O = 200\text{ mV}_{\text{PP}}$				20			MHz
SR	Slew Rate <sup>(3)</sup>	$V_O = 2\text{ V}_{\text{PP}}$				80			V/ $\mu\text{s}$
$T_S$	Settling Time	$V_O = 2\text{ V}_{\text{PP}}$ to $\pm 0.1\%$				45			ns
		$V_O = 2\text{ V}_{\text{PP}}$ to $\pm 1.0\%$				40			
$T_r$	Rise Time	$V_O = 0.2\text{ V Step}$ , 10% to 90%				2.5			ns
$T_f$	Fall Time	$V_O = 0.2\text{ V Step}$ , 10% to 90%				2.5			ns

(1) All limits are specified by testing or statistical analysis.

(2) Typical values represent the most likely parametric norm.

(3) Slew rate is the slowest of the rising and falling slew rates.

## ±2.5 V Electrical Characteristics (continued)

Unless otherwise specified,  $T_J = 25^\circ\text{C}$ ,  $V_+ = 2.5\text{ V}$ ,  $V_- = -2.5\text{ V}$ ,  $V_{CM} = 0\text{ V}$ ,  $A_V = +2$ ,  $R_F = 500\ \Omega$ ,  $R_L = 100\ \Omega$ . Some limits apply at the temperature extremes as noted in the table.

PARAMETER		TEST CONDITIONS	TEMPERATURE EXTREMES			ROOM TEMPERATURE			UNIT
			MIN <sup>(1)</sup>	TYP <sup>(2)</sup>	MAX <sup>(1)</sup>	MIN <sup>(1)</sup>	TYP <sup>(2)</sup>	MAX <sup>(1)</sup>	
<b>DISTORTION and NOISE RESPONSE</b>									
$e_n$	Input Referred Voltage Noise	$f = 100\text{ kHz}$					1.7		$\text{nV}/\sqrt{\text{Hz}}$
$i_n$	Input Referred Current Noise	$f = 100\text{ kHz}$					1.5		$\text{pA}/\sqrt{\text{Hz}}$
HD2	2 <sup>nd</sup> Harmonic Distortion	$f_c = 1\text{ MHz}$ , $V_O = 2V_{PP}$ , $R_L = 100\ \Omega$					-88		dBc
		$f_c = 1\text{ MHz}$ , $V_O = 2V_{PP}$ , $R_L = 500\ \Omega$					-98		
HD3	3 <sup>rd</sup> Harmonic Distortion	$f_c = 1\text{ MHz}$ , $V_O = 2V_{PP}$ , $R_L = 100\ \Omega$					-92		dBc
		$f_c = 1\text{ MHz}$ , $V_O = 2V_{PP}$ , $R_L = 500\ \Omega$					-100		
MTPR	Upstream	$V_O = 0.4V_{RMS}$ , 26kHz to 132kHz (see <a href="#">Figure 33</a> )					-76		dBc
	Downstream	$V_O = 0.4V_{RMS}$ , 144 kHz to 1.1 MHz (see <a href="#">Figure 33</a> )					-68		
<b>INPUT CHARACTERISTICS</b>									
$V_{OS}$	Input Offset Voltage	$V_{CM} = 0\text{ V}$	-2.3		+2.3	-1.5	+0.3	+1.5	mV
TC $V_{OS}$	Input Offset Average Drift	$V_{CM} = 0\text{ V}$ <sup>(4)</sup>					-2.5		$\mu\text{V}/^\circ\text{C}$
$I_{OS}$	Input Offset Current	$V_{CM} = 0\text{ V}$	-2.5		2.5	-1.5	+0.01	1.5	$\mu\text{A}$
$I_B$	Input Bias Current	$V_{CM} = 0\text{ V}$			15		4.6	10	$\mu\text{A}$
$R_{IN}$	Input Resistance	Common Mode					17		M $\Omega$
		Differential Mode					12		k $\Omega$
$C_{IN}$	Input Capacitance	Common Mode					0.9		pF
		Differential Mode					1.0		pF
CMVR	Input Common Mode Voltage Range	CMRR $\geq 60\text{dB}$					-1.25	-1	V
						2	+2.2		
CMRR	Common Mode Rejection Ratio	Input Referred, $V_{CM} = -0.7\text{ V}$ to $+1.7\text{ V}$	75			80	100		dB
<b>TRANSFER CHARACTERISTICS</b>									
$A_{VOL}$	Large Signal Voltage Gain	$V_O = 1V_{PP}$				74	82		dB
$X_t$	Crosstalk	$f = 1\text{ MHz}$					-75		dB

(4) Offset voltage average drift is determined by dividing the change in  $V_{OS}$  at temperature extremes into the total temperature change.

### ±2.5 V Electrical Characteristics (continued)

Unless otherwise specified,  $T_J = 25^\circ\text{C}$ ,  $V_+ = 2.5\text{ V}$ ,  $V_- = -2.5\text{ V}$ ,  $V_{CM} = 0\text{ V}$ ,  $A_V = +2$ ,  $R_F = 500\ \Omega$ ,  $R_L = 100\ \Omega$ . Some limits apply at the temperature extremes as noted in the table.

PARAMETER		TEST CONDITIONS	TEMPERATURE EXTREMES			ROOM TEMPERATURE			UNIT
			MIN <sup>(1)</sup>	TYP <sup>(2)</sup>	MAX <sup>(1)</sup>	MIN <sup>(1)</sup>	TYP <sup>(2)</sup>	MAX <sup>(1)</sup>	
<b>OUTPUT CHARACTERISTICS</b>									
$V_O$	Output Swing	No Load, Positive Swing	1.2			1.4	1.7		V
		No Load, Negative Swing	-1			-1.5	-1.2		
		$R_L = 100\ \Omega$ , Positive Swing	1			1.2	1.5		
		$R_L = 100\ \Omega$ , Negative Swing	-0.9			-1.4	-1.1		
$R_O$	Output Impedance	$f = 1\text{ MHz}$				0.1		$\Omega$	
$I_{SC}$	Output Short Circuit Current	Sourcing to Ground $\Delta V_{IN} = 200\text{ mV}^{(5)(6)}$				100	137		mA
		Sinking to Ground $\Delta V_{IN} = -200\text{ mV}^{(5)(6)}$				100	134		
$I_{OUT}$	Output Current	Sourcing, $V_O = +0.8\text{ V}$ Sinking, $V_O = -0.8\text{ V}$				90		mA	
<b>POWER SUPPLY</b>									
+PSRR	Positive Power Supply Rejection Ratio	Input Referred, $V_S = +2.5\text{ V to }+3\text{ V}$	72			78	93		dB
-PSRR	Negative Power Supply Rejection Ratio	Input Referred, $V_S = -2.5\text{ V to }-3\text{ V}$	70			75	88		dB
$I_S$	Supply Current (per amplifier)	No Load	6.4			4.1	5.8		mA

- (5) Applies to both single-supply and split-supply operation. Continuous short circuit operation at elevated ambient temperature can result in exceeding the maximum allowed junction temperature of  $150^\circ\text{C}$ .
- (6) Short circuit test is a momentary test. Output short circuit duration is infinite for  $V_S \leq \pm 2.5\text{ V}$ , at room temperature and below. For  $V_S > \pm 2.5\text{ V}$ , allowable short circuit duration is 1.5ms.



### 6.7 Typical Performance Characteristics

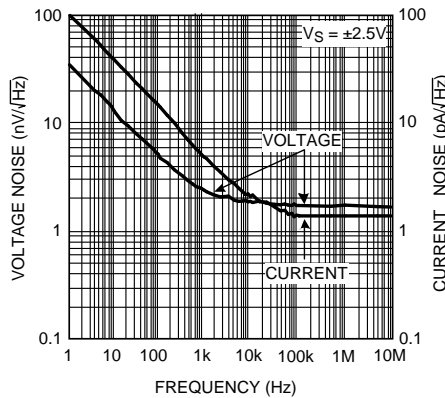


Figure 1. Current and Voltage Noise vs. Frequency

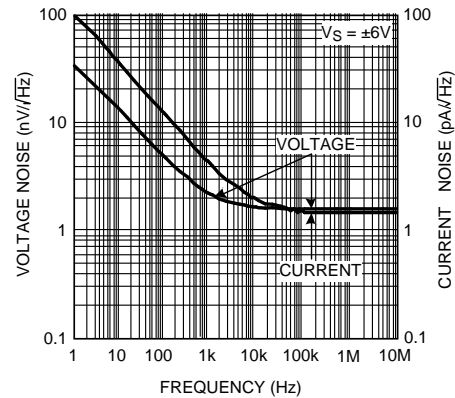


Figure 2. Current and Voltage Noise vs. Frequency

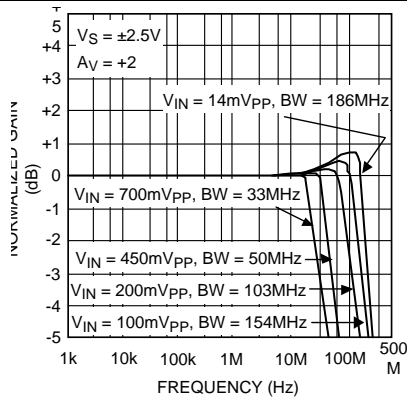


Figure 3. Frequency Response vs. Input Signal Level

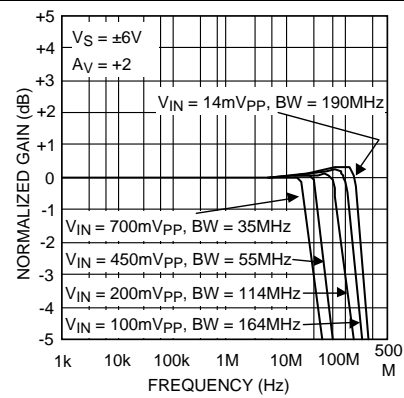


Figure 4. Frequency Response vs. Input Signal Level

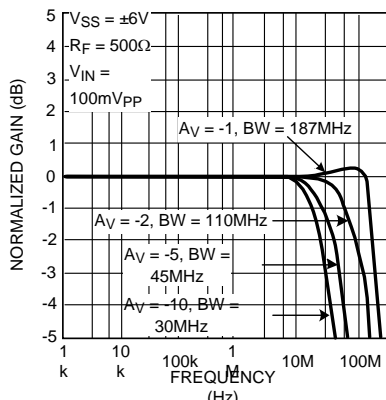


Figure 5. Inverting Amplifier Frequency Response

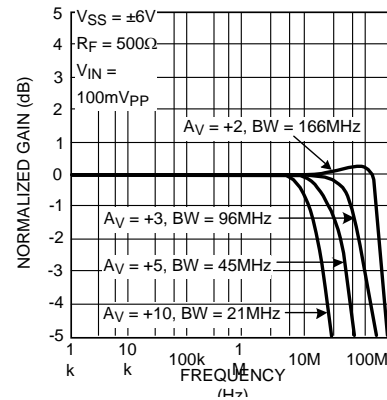


Figure 6. Non-Inverting Amplifier Frequency Response

Typical Performance Characteristics (continued)

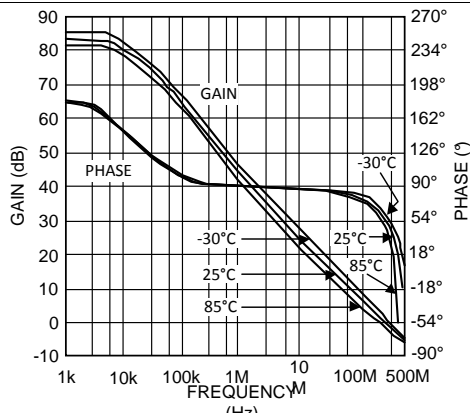


Figure 7. Open Loop Gain and Phase Response

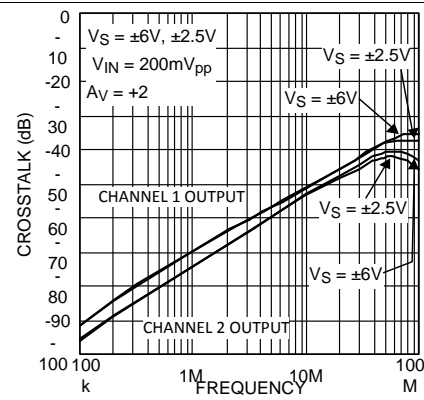


Figure 8. Crosstalk vs. Frequency

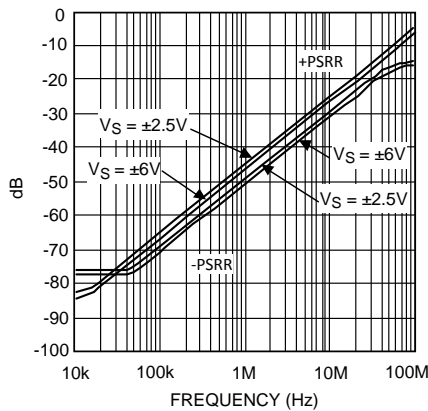


Figure 9. PSRR vs. Frequency

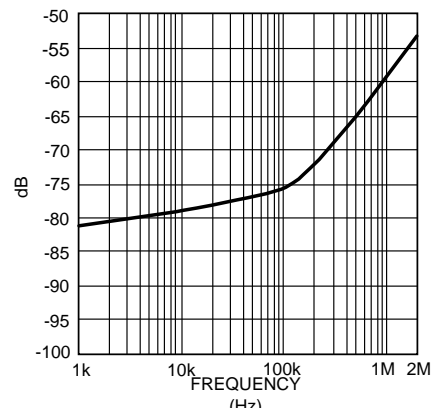


Figure 10. CMRR vs. Frequency

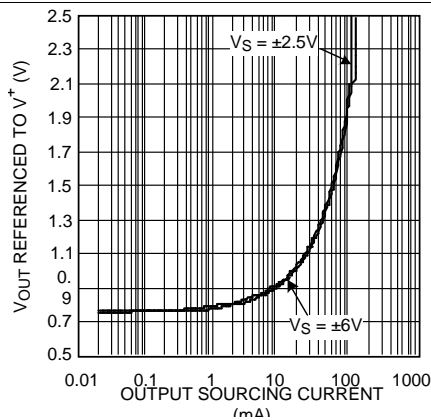


Figure 11. Positive Output Swing vs. Source Current

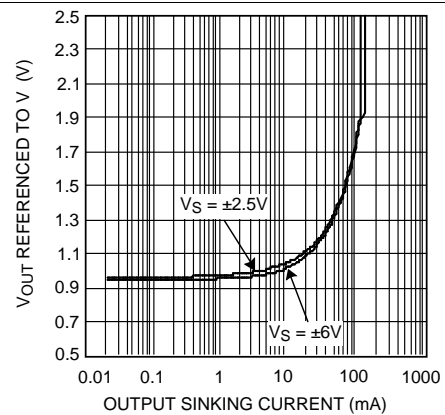


Figure 12. Negative Output Swing vs. Sink Current

Typical Performance Characteristics (continued)

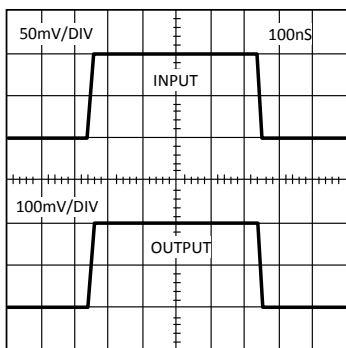


Figure 13. Non-Inverting Small Signal Pulse Response  
 $V_S = \pm 2.5\text{ V}$ ,  $R_L = 100\ \Omega$ ,  $A_V = +2$ ,  $R_F = 500\ \Omega$

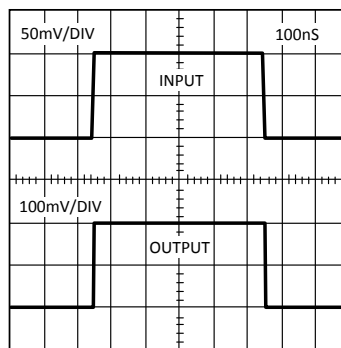


Figure 14. Non-Inverting Small Signal Pulse Response  
 $V_S = \pm 6\text{ V}$ ,  $R_L = 100\ \Omega$ ,  $A_V = +2$ ,  $R_F = 500\ \Omega$

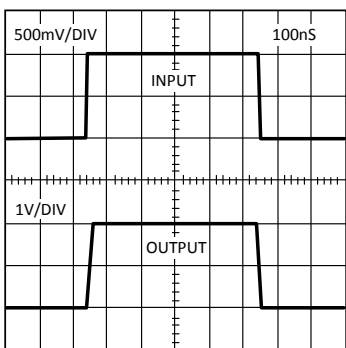


Figure 15. Non-Inverting Large Signal Pulse Response  
 $V_S = \pm 2.5\text{ V}$ ,  $R_L = 100\ \Omega$ ,  $A_V = +2$ ,  $R_F = 500\ \Omega$

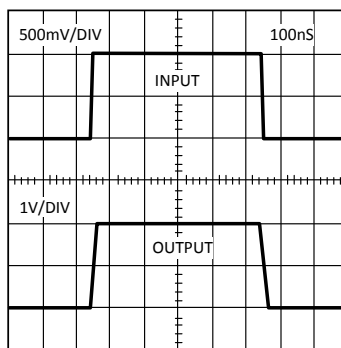


Figure 16. Non-Inverting Large Signal Pulse Response  
 $V_S = \pm 6\text{ V}$ ,  $R_L = 100\ \Omega$ ,  $A_V = +2$ ,  $R_F = 500\ \Omega$

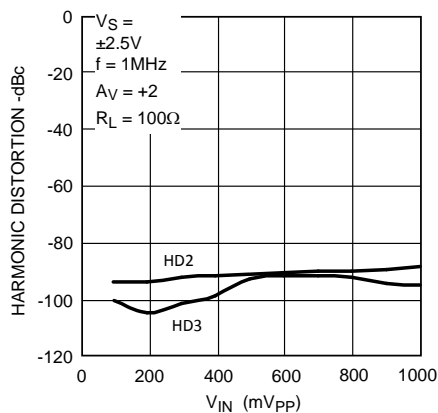


Figure 17. Harmonic Distortion vs. Input Signal Level

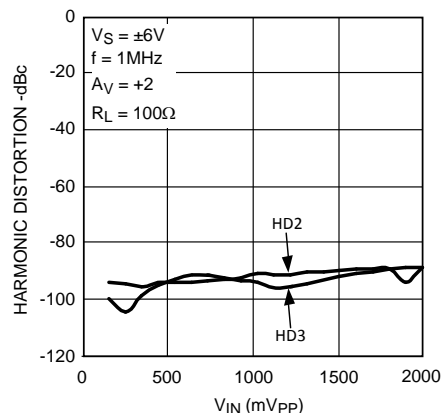


Figure 18. Harmonic Distortion vs. Input Signal Level

Typical Performance Characteristics (continued)

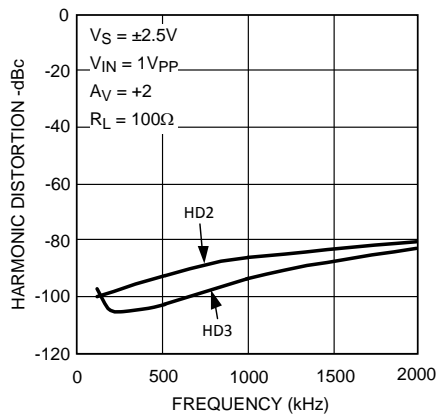


Figure 19. Harmonic Distortion vs. Frequency

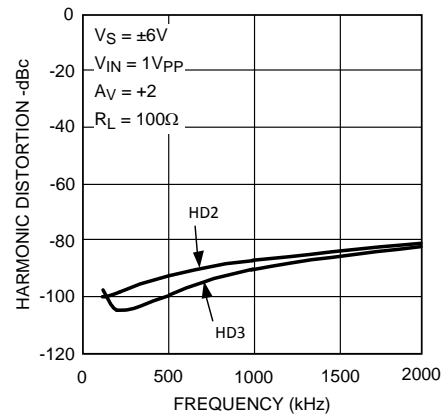


Figure 20. Harmonic Distortion vs. Frequency

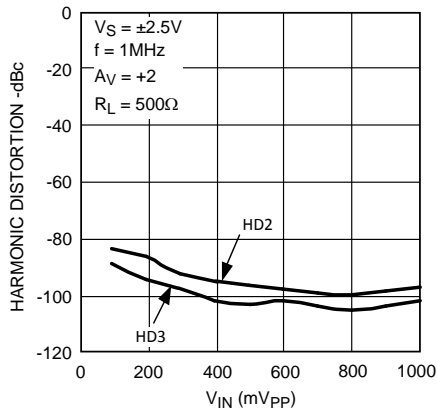


Figure 21. Harmonic Distortion vs. Input Signal Level

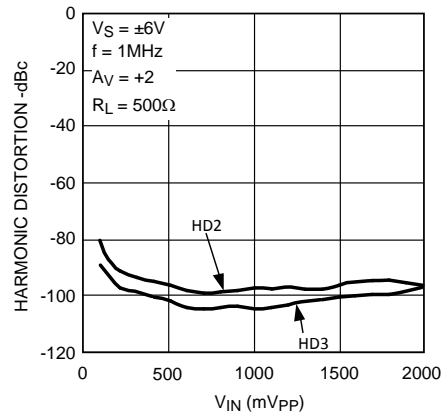


Figure 22. Harmonic Distortion vs. input Signal Level

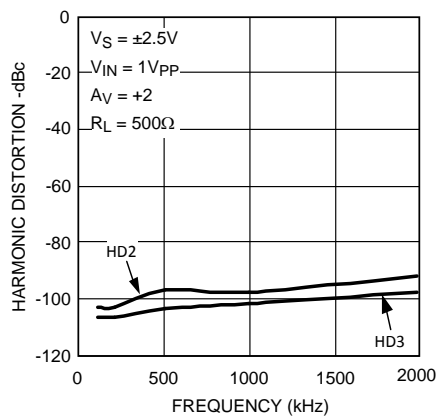


Figure 23. Harmonic Distortion vs. Input Frequency

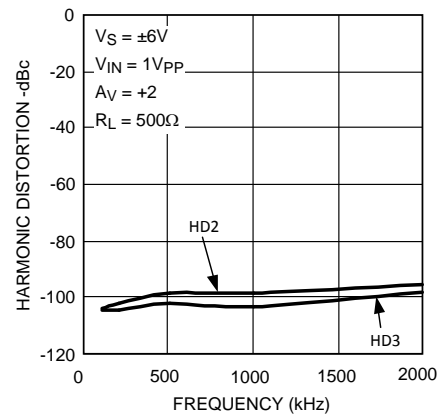


Figure 24. Harmonic Distortion vs. Input Frequency

Typical Performance Characteristics (continued)

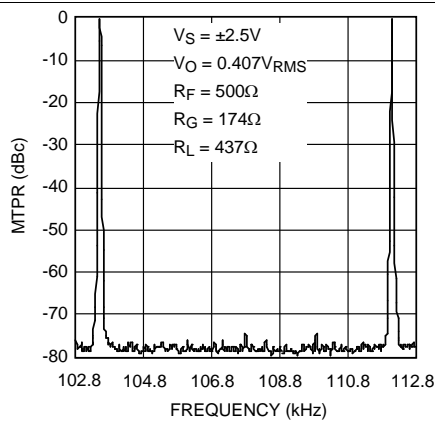


Figure 25. Full Rate ADSL (DMT) Upstream MTPR @  $V_S = \pm 2.5\text{ V}$

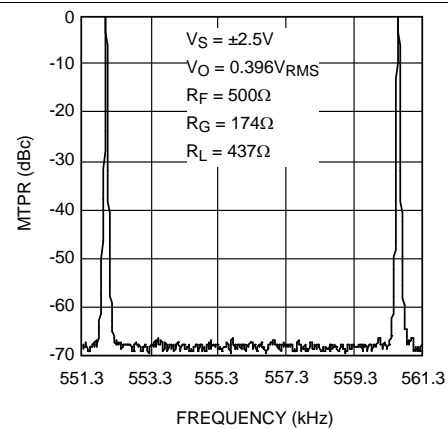


Figure 26. Full Rate ADSL (DMT) Downstream MTPR @  $V_S = \pm 2.5\text{ V}$

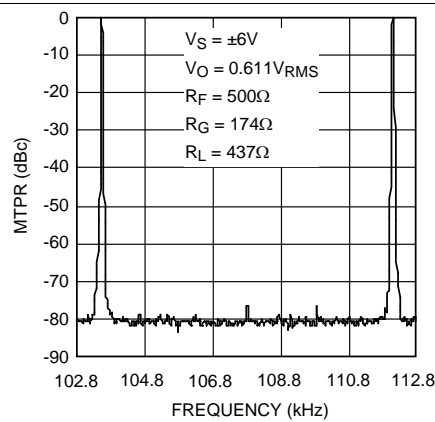


Figure 27. Full Rate ADSL (DMT) Upstream MTPR @  $V_S = \pm 6\text{ V}$

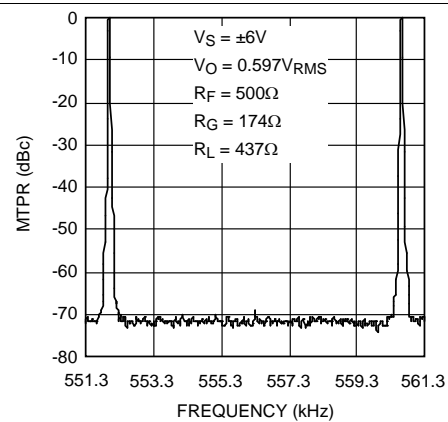
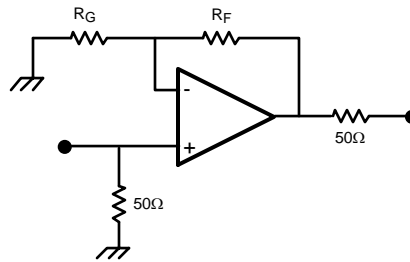


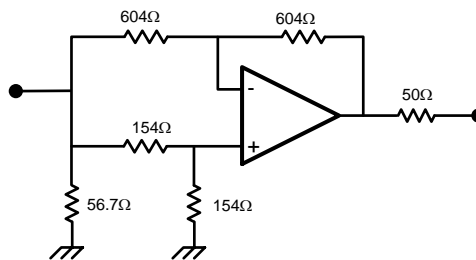
Figure 28. Full Rate ADSL (DMT) Downstream MTPR @  $V_S = \pm 6\text{ V}$

## 7 Parameter Measurement Information

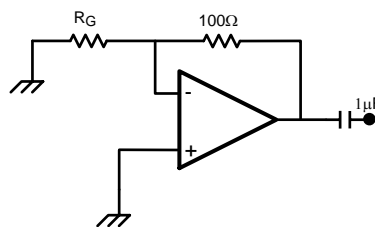
### 7.1 Test Circuits



**Figure 29. Non-Inverting Amplifier**

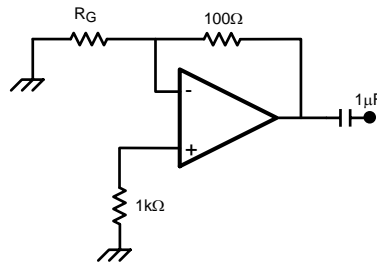


**Figure 30. CMRR**

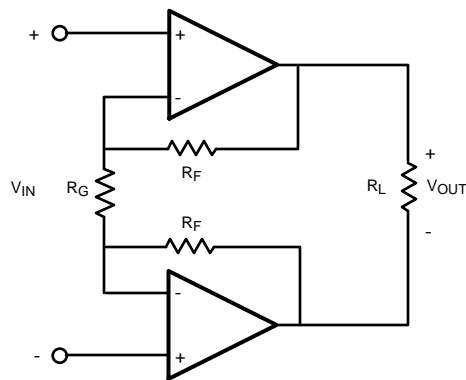


**Figure 31. Voltage Noise**  
 $R_G = 1\ \Omega$  for  $f \leq 100\ \text{kHz}$ ,  $R_G = 20\ \Omega$  for  $f > 100\ \text{kHz}$

Test Circuits (continued)



**Figure 32. Current Noise**  
 $R_G = 1 \Omega$  for  $f \leq 100 \text{ kHz}$ ,  $R_G = 20 \Omega$  for  $f > 100 \text{ kHz}$



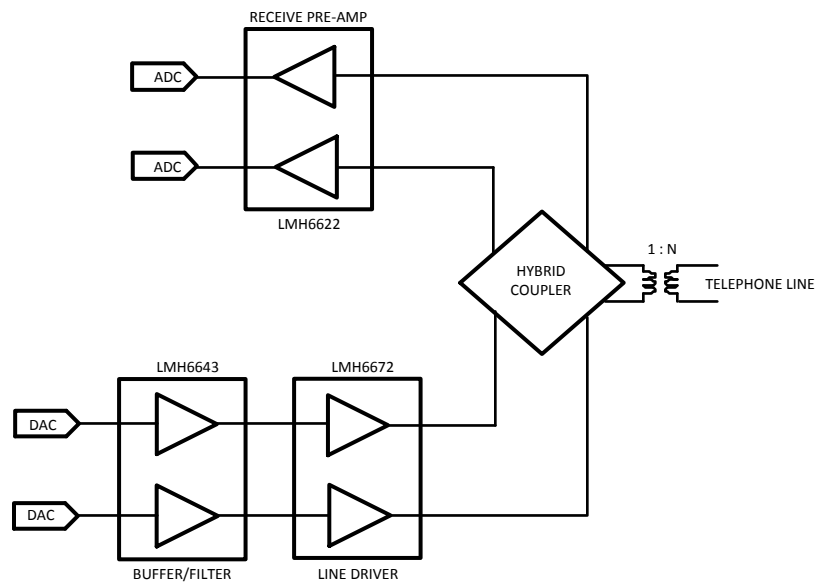
**Figure 33. Multitone Power Ratio,  $R_F = 500 \Omega$ ,  $R_G = 174 \Omega$ ,  $R_L = 437 \Omega$**

## 8 Detailed Description

### 8.1 Overview

The LMH6622 is a dual high speed voltage operational amplifier specifically optimized for low noise. The LMH6622 operates from  $\pm 2.5$  V to  $\pm 6$  V in dual supply mode and from +5 V to +12 V in single supply configuration.

### 8.2 Functional Block Diagram



**Figure 34. xDSL Analog Front End**

### 8.3 Feature Description

- 4.5 V to 12 V supply range
- Large linear output current of 90 mA
- Excellent harmonic distortion of 90 dBc

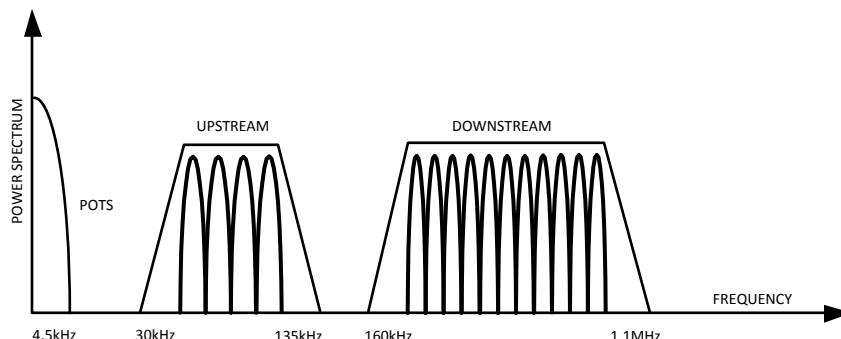
### 8.4 Device Functional Modes

- Single or dual supplies
- Traditional voltage feedback topology for maximum flexibility



## 9 Application and Implementation

### 9.1 DSL Receive Channel Applications



**Figure 35. ADSL Signal Description**

The LMH6622 is a dual, wideband operational amplifier designed for use as a DSL line receiver. In the receive band of a Customer Premises Equipment (CPE) ADSL modem it is possible that as many as 255 Discrete Multi-Tone (DMT) QAM signals will be present, each with its own carrier frequency, modulation, and signal level. The ADSL standard requires a line referred noise power density of -140 dBm/Hz within the CPE receive band of 100 KHz to 1.1 MHz. The CPE driver output signal will leak into the receive path because of full duplex operation and the imperfections of the hybrid coupler circuit. The DSL analog front end must incorporate a receiver pre-amp which is both low noise and highly linear for ADSL-standard operation. The LMH6622 is designed for the twin performance parameters of low noise and high linearity.



## DSL Receive Channel Applications (continued)

Therefore,

$$V_1 = \frac{1}{2}V_A \quad \text{and} \quad V_2 = -\frac{1}{4}V_A - \frac{1}{2}V_{T1} \quad (5)$$

And then,

$$V_{OUT} = -R_F \left[ \frac{V_A}{2R_1} - \frac{V_A}{4R_2} - \frac{V_{T1}}{2R_2} \right] \quad (6)$$

Setting  $R_1 = 2R_2$  to cancel unwanted driver signal in the receive path, then we have

$$V_{OUT} = \frac{R_F}{2R_2} V_{T1} \quad (7)$$

We can also find that,

$$V_{TN} = \frac{1}{2}V_S \quad \text{and} \quad V_{T1} = \frac{1}{N}V_{TN} = \frac{1}{2N}V_S \quad (8)$$

And then

$$V_{OUT} = \frac{R_F}{4NR_2} V_S \quad (9)$$

In conclusion, the peak-to-peak voltage to the ADC would be,

$$2 V_{OUT} = \frac{R_F}{2NR_2} V_S \quad (10)$$

## 9.2 Receive Channel Noise Calculation

The circuit of [Figure 36](#) also has the characteristic that it cancels noise power from the drive channel.

The noise gain of the receive pre-amp is found to be:

$$A_n = 1 + \frac{R_F}{R_1/R_2} \quad (11)$$

Noise power at each of the output of LMH6622:

$$e_o^2 = A_n^2 [V_n^2 + i_{non-inv}^2 R_+^2 + 4kT R_+] + i_{inv}^2 R_F^2 + 4kT R_F A_n$$

where

- $V_n$  is the Input referred voltage noise
  - $i_n$  is the Input referred current noise
  - $i_{non-inv}$  is the Input referred non-inverting current noise
  - $i_{inv}$  is the Input referred inverting current noise
  - $k$  is the Boltzmann's constant,  $K = 1.38 \times 10^{-23}$
  - $T$  is the Resistor temperature in k
  - $R_+$  is the source resistance at the non-inverting input to balance offset voltage, typically very small for this inverting summing applications
- (12)

For a voltage feedback amplifier,

$$i_{inv} = i_{non-inv} = i_n \quad (13)$$

Therefore, total output noise from the differential pre-amp is:

$$e_{TotalOutput}^2 = 2 e_o^2 \quad (14)$$

The factor '2' appears here because of differential output.

### 9.3 Differential Analog-to-Digital Driver

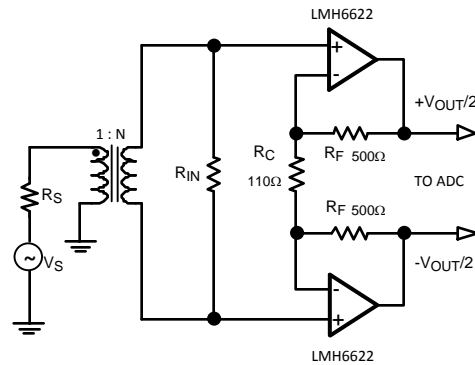


Figure 37. Circuit for Differential A/D Driver

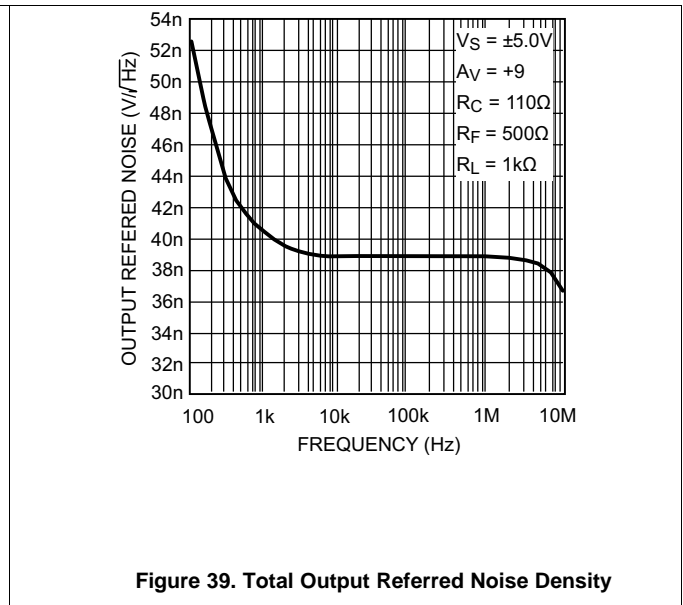
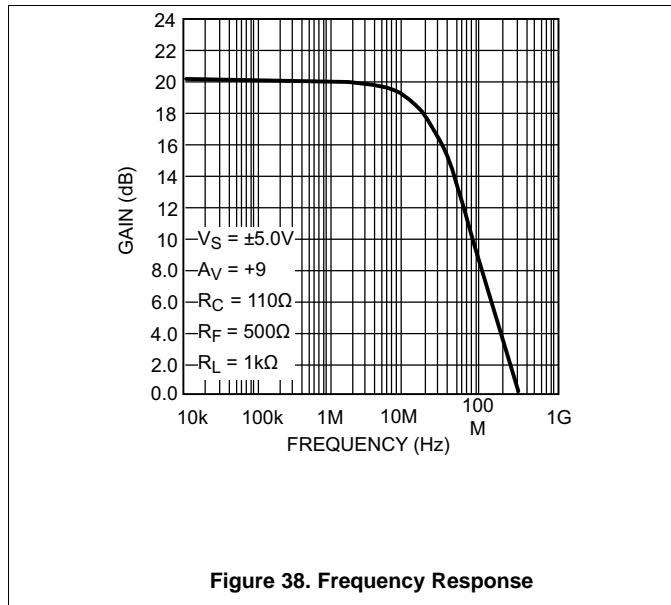
The LMH6622 is a low noise, low distortion high speed operational amplifier. The LMH6622 comes in either SOIC-8 or VSSOP-8 packages. Because two channels are available in each package the LMH6622 can be used as a high dynamic range differential amplifier for the purpose of driving a high speed analog-to-digital converter. Driving a 1 kΩ load, the differential amplifier of Figure 37 provides 20 dB gain, a flat frequency response up to 6 MHz, and harmonic distortion that is lower than 80 dBc. This circuit makes use of a transformer to convert a single-ended signal to a differential signal. The input resistor  $R_{IN}$  is chosen by the following equation,

$$R_{IN} = \frac{1}{N^2} R_S \tag{15}$$

The gain of this differential amplifier can be adjusted by  $R_C$  and  $R_F$ ,

$$A_V = 2 \frac{R_F}{R_C} \tag{16}$$

See Figure 38 and Figure 39 below for plots related to the discussion of Figure 37.



## 9.4 Typical Application

See [Figure 40](#) for application circuit.

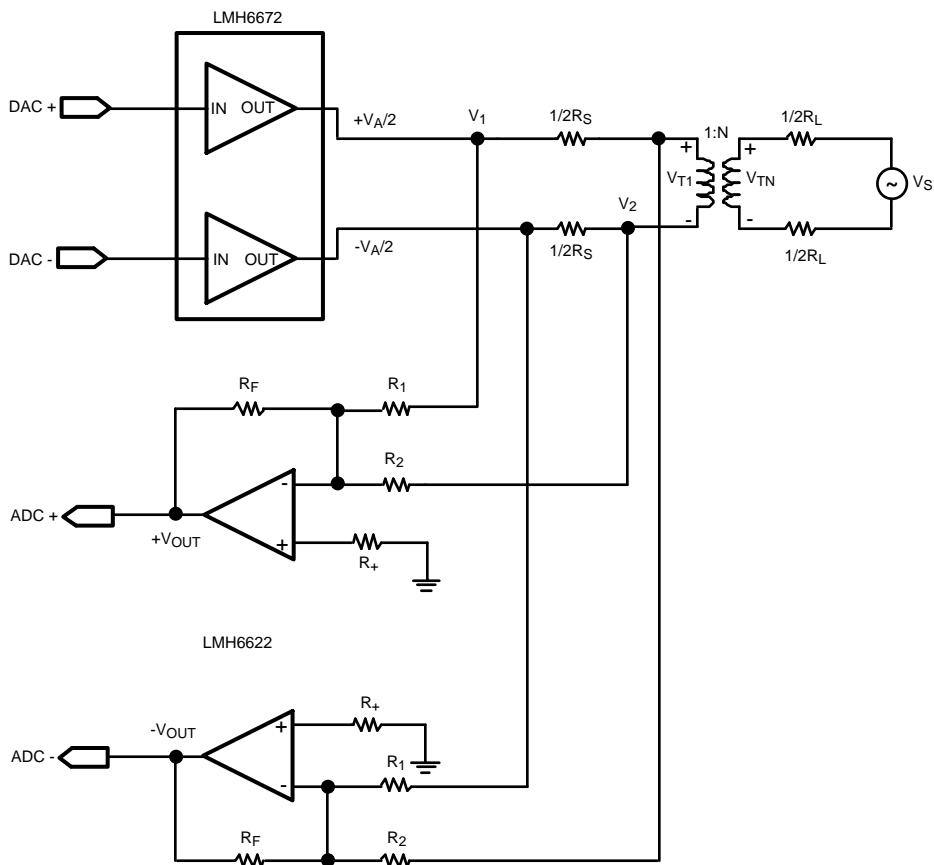


Figure 40. ADSL Receive Applications Circuit

### 9.4.1 Design Requirements

All normal precautions / considerations with Op Amps apply

### 9.4.2 Detailed Design Procedure

- Use power supply decoupling capacitors close to supply pins
- Beware of junction temperature rise at elevated ambient temperature and / or heavy output(s) load current especially at higher supply voltages
- Ground plane near sensitive input pins can be removed to minimize parasitic capacitance

### 9.4.3 Application Curves

See [Figure 38](#) and [Figure 39](#).

## 10 Power Supply Recommendations

### 10.1 Driving Capacitive Load

Capacitive Loads decrease the phase margin of all op amps. The output impedance of a feedback amplifier becomes inductive at high frequencies, creating a resonant circuit when the load is capacitive. This can lead to overshoot, ringing and oscillation. To eliminate oscillation or reduce ringing, an isolation resistor can be placed between the load and the output. In general, the bigger the isolation resistor, the more damped the pulse response becomes. For initial evaluation, a 50  $\Omega$  isolation resistor is recommended.

## 11 Layout

### 11.1 Layout Guidelines

#### 11.1.1 Circuit Layout Considerations

Texas Instruments suggests the copper patterns on the evaluation boards listed below as a guide for high frequency layout. These boards are also useful as an aid in device testing and characterization. As is the case with all high-speed amplifiers, accepted-practice  $R_F$  design technique on the PCB layout is mandatory. Generally, a good high frequency layout exhibits a separation of power supply and ground traces from the inverting input and output pins. Parasitic capacitances between these nodes and ground will cause frequency response peaking and possible circuit oscillations (see [SNOA367](#), Application Note OA-15, for more information). High quality chip capacitors with values in the range of 1000 pF to 0.1  $\mu$ F should be used for power supply bypassing. One terminal of each chip capacitor is connected to the ground plane and the other terminal is connected to a point that is as close as possible to each supply pin as allowed by the manufacturer's design rules. In addition, a tantalum capacitor with a value between 4.7  $\mu$ F and 10  $\mu$ F should be connected in parallel with the chip capacitor. Signal lines connecting the feedback and gain resistors should be as short as possible to minimize inductance and microstrip line effect. Input and output termination resistors should be placed as close as possible to the input/output pins. Traces greater than 1 inch in length should be impedance matched to the corresponding load termination.

Symmetry between the positive and negative paths in the layout of differential circuitry should be maintained so as to minimize the imbalance of amplitude and phase of the differential signal.

DEVICE	PACKAGE	EVALUATION BOARD P/N
LMH6622MA	SOIC-8	LMH730036
LMH6622MM	VSSOP-8	LMH730123

Component value selection is another important parameter in working with high speed/high performance amplifiers. Choosing external resistors that are large in value compared to the value of other critical components will affect the closed loop behavior of the stage because of the interaction of these resistors with parasitic capacitances. These parasitic capacitors could either be inherent to the device or be a by-product of the board layout and component placement. Moreover, a large resistor will also add more thermal noise to the signal path. Either way, keeping the resistor values low will diminish this interaction. On the other hand, choosing very low value resistors could load down nodes and will contribute to higher overall power dissipation and worse distortion.

## 11.2 Layout Examples

### 11.2.1 SOIC Layout Example

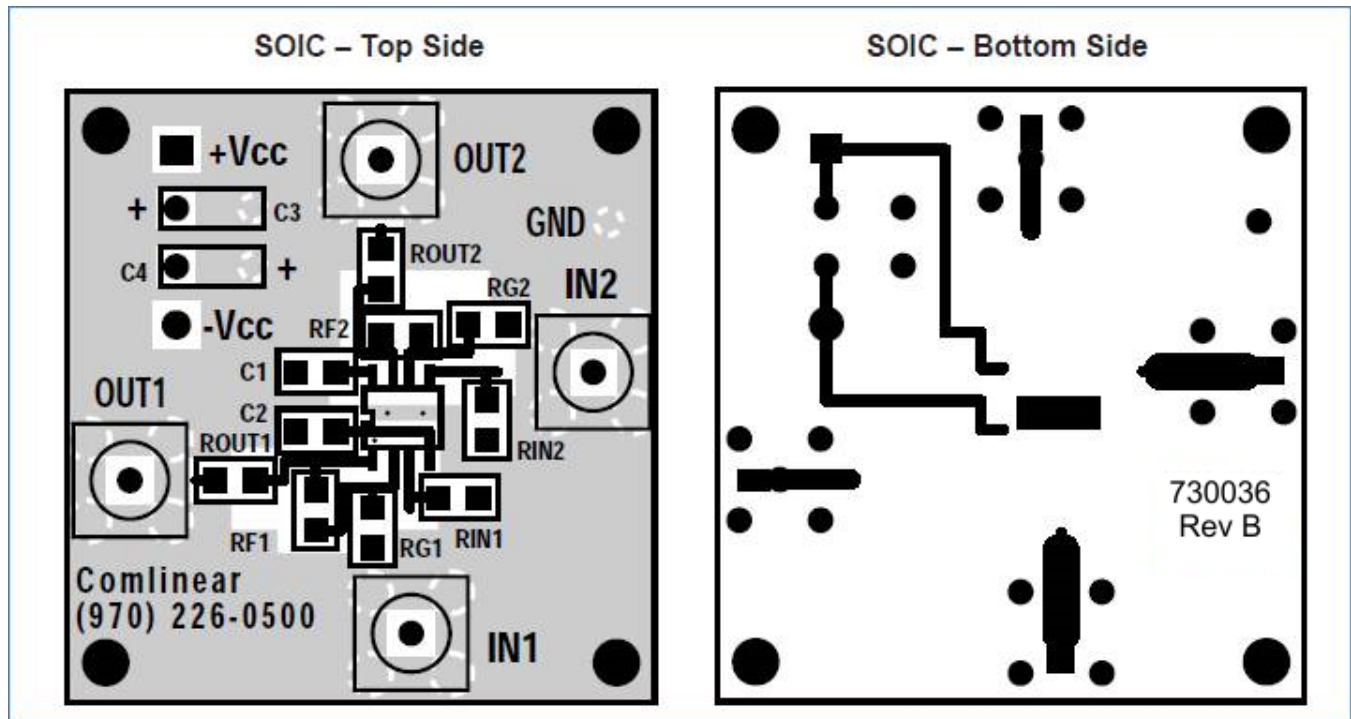
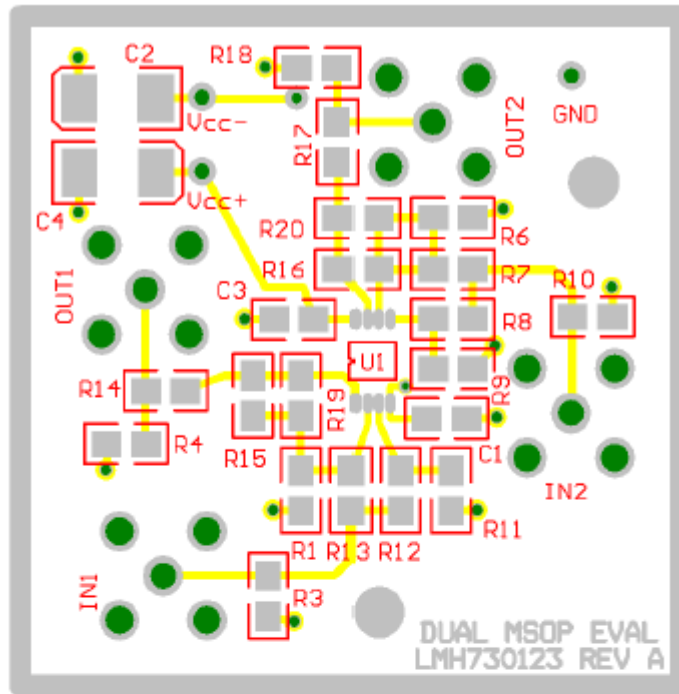


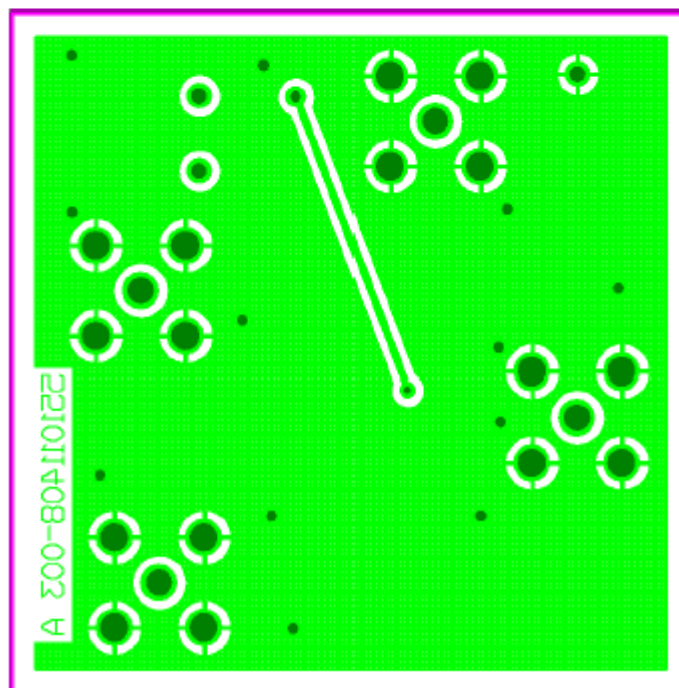
Figure 41. LMH6622 Layout Example - SOIC

Layout Examples (continued)

11.2.2 VSSOP Layout Example



Top Layer (2x scale)



Bottom Layer (Top View, 2x scale)

Figure 42. LMH6622 Layout Example - VSSOP



## 12 Device and Documentation Support

### 12.1 Trademarks

All trademarks are the property of their respective owners.

### 12.2 Electrostatic Discharge Caution



These devices have limited built-in ESD protection. The leads should be shorted together or the device placed in conductive foam during storage or handling to prevent electrostatic damage to the MOS gates.

### 12.3 Glossary

[SLYZ022](#) — *TI Glossary*.

This glossary lists and explains terms, acronyms, and definitions.

## 13 Mechanical, Packaging, and Orderable Information

The following pages include mechanical, packaging, and orderable information. This information is the most current data available for the designated devices. This data is subject to change without notice and revision of this document. For browser-based versions of this data sheet, refer to the left-hand navigation.

**PACKAGING INFORMATION**

Orderable Device	Status (1)	Package Type	Package Drawing	Pins	Package Qty	Eco Plan (2)	Lead finish/ Ball material (6)	MSL Peak Temp (3)	Op Temp (°C)	Device Marking (4/5)	Samples
LMH6622MA/NOPB	ACTIVE	SOIC	D	8	95	RoHS & Green	SN	Level-1-260C-UNLIM	-40 to 85	LMH66 22MA	<a href="#">Samples</a>
LMH6622MAX/NOPB	ACTIVE	SOIC	D	8	2500	RoHS & Green	SN	Level-1-260C-UNLIM	-40 to 85	LMH66 22MA	<a href="#">Samples</a>
LMH6622MM/NOPB	ACTIVE	VSSOP	DGK	8	1000	RoHS & Green	SN	Level-1-260C-UNLIM	-40 to 85	A80A	<a href="#">Samples</a>
LMH6622MMX/NOPB	ACTIVE	VSSOP	DGK	8	3500	RoHS & Green	SN	Level-1-260C-UNLIM	-40 to 85	A80A	<a href="#">Samples</a>

(1) The marketing status values are defined as follows:

**ACTIVE:** Product device recommended for new designs.

**LIFEBUY:** TI has announced that the device will be discontinued, and a lifetime-buy period is in effect.

**NRND:** Not recommended for new designs. Device is in production to support existing customers, but TI does not recommend using this part in a new design.

**PREVIEW:** Device has been announced but is not in production. Samples may or may not be available.

**OBSELETE:** TI has discontinued the production of the device.

(2) **RoHS:** TI defines "RoHS" to mean semiconductor products that are compliant with the current EU RoHS requirements for all 10 RoHS substances, including the requirement that RoHS substance do not exceed 0.1% by weight in homogeneous materials. Where designed to be soldered at high temperatures, "RoHS" products are suitable for use in specified lead-free processes. TI may reference these types of products as "Pb-Free".

**RoHS Exempt:** TI defines "RoHS Exempt" to mean products that contain lead but are compliant with EU RoHS pursuant to a specific EU RoHS exemption.

**Green:** TI defines "Green" to mean the content of Chlorine (Cl) and Bromine (Br) based flame retardants meet JS709B low halogen requirements of <=1000ppm threshold. Antimony trioxide based flame retardants must also meet the <=1000ppm threshold requirement.

(3) MSL, Peak Temp. - The Moisture Sensitivity Level rating according to the JEDEC industry standard classifications, and peak solder temperature.

(4) There may be additional marking, which relates to the logo, the lot trace code information, or the environmental category on the device.

(5) Multiple Device Markings will be inside parentheses. Only one Device Marking contained in parentheses and separated by a "-" will appear on a device. If a line is indented then it is a continuation of the previous line and the two combined represent the entire Device Marking for that device.

(6) Lead finish/Ball material - Orderable Devices may have multiple material finish options. Finish options are separated by a vertical ruled line. Lead finish/Ball material values may wrap to two lines if the finish value exceeds the maximum column width.

**Important Information and Disclaimer:**The information provided on this page represents TI's knowledge and belief as of the date that it is provided. TI bases its knowledge and belief on information provided by third parties, and makes no representation or warranty as to the accuracy of such information. Efforts are underway to better integrate information from third parties. TI has taken and

continues to take reasonable steps to provide representative and accurate information but may not have conducted destructive testing or chemical analysis on incoming materials and chemicals. TI and TI suppliers consider certain information to be proprietary, and thus CAS numbers and other limited information may not be available for release.

In no event shall TI's liability arising out of such information exceed the total purchase price of the TI part(s) at issue in this document sold by TI to Customer on an annual basis.

**TAPE AND REEL INFORMATION**

**QUADRANT ASSIGNMENTS FOR PIN 1 ORIENTATION IN TAPE**


\*All dimensions are nominal

Device	Package Type	Package Drawing	Pins	SPQ	Reel Diameter (mm)	Reel Width W1 (mm)	A0 (mm)	B0 (mm)	K0 (mm)	P1 (mm)	W (mm)	Pin1 Quadrant
LMH6622MAX/NOPB	SOIC	D	8	2500	330.0	12.4	6.5	5.4	2.0	8.0	12.0	Q1
LMH6622MM/NOPB	VSSOP	DGK	8	1000	178.0	12.4	5.3	3.4	1.4	8.0	12.0	Q1
LMH6622MMX/NOPB	VSSOP	DGK	8	3500	330.0	12.4	5.3	3.4	1.4	8.0	12.0	Q1

**TAPE AND REEL BOX DIMENSIONS**


\*All dimensions are nominal

Device	Package Type	Package Drawing	Pins	SPQ	Length (mm)	Width (mm)	Height (mm)
LMH6622MAX/NOPB	SOIC	D	8	2500	367.0	367.0	35.0
LMH6622MM/NOPB	VSSOP	DGK	8	1000	208.0	191.0	35.0
LMH6622MMX/NOPB	VSSOP	DGK	8	3500	367.0	367.0	35.0

**TUBE**


\*All dimensions are nominal

Device	Package Name	Package Type	Pins	SPQ	L (mm)	W (mm)	T (μm)	B (mm)
LMH6622MA/NOPB	D	SOIC	8	95	495	8	4064	3.05



D0008A

# PACKAGE OUTLINE

SOIC - 1.75 mm max height

SMALL OUTLINE INTEGRATED CIRCUIT



4214825/C 02/2019

NOTES:

1. Linear dimensions are in inches [millimeters]. Dimensions in parenthesis are for reference only. Controlling dimensions are in inches. Dimensioning and tolerancing per ASME Y14.5M.
2. This drawing is subject to change without notice.
3. This dimension does not include mold flash, protrusions, or gate burrs. Mold flash, protrusions, or gate burrs shall not exceed .006 [0.15] per side.
4. This dimension does not include interlead flash.
5. Reference JEDEC registration MS-012, variation AA.

# EXAMPLE BOARD LAYOUT

D0008A

SOIC - 1.75 mm max height

SMALL OUTLINE INTEGRATED CIRCUIT



LAND PATTERN EXAMPLE  
EXPOSED METAL SHOWN  
SCALE:8X



SOLDER MASK DETAILS

4214825/C 02/2019

NOTES: (continued)

- 6. Publication IPC-7351 may have alternate designs.
- 7. Solder mask tolerances between and around signal pads can vary based on board fabrication site.



# EXAMPLE STENCIL DESIGN

D0008A

SOIC - 1.75 mm max height

SMALL OUTLINE INTEGRATED CIRCUIT



SOLDER PASTE EXAMPLE  
BASED ON .005 INCH [0.125 MM] THICK STENCIL  
SCALE:8X

4214825/C 02/2019

NOTES: (continued)

8. Laser cutting apertures with trapezoidal walls and rounded corners may offer better paste release. IPC-7525 may have alternate design recommendations.
9. Board assembly site may have different recommendations for stencil design.

DGK (S-PDSO-G8)

PLASTIC SMALL-OUTLINE PACKAGE



- NOTES:
- A. All linear dimensions are in millimeters.
  - B. This drawing is subject to change without notice.
  - C. Body length does not include mold flash, protrusions, or gate burrs. Mold flash, protrusions, or gate burrs shall not exceed 0.15 per end.
  - D. Body width does not include interlead flash. Interlead flash shall not exceed 0.50 per side.
  - E. Falls within JEDEC MO-187 variation AA, except interlead flash.



- NOTES:
- A. All linear dimensions are in millimeters.
  - B. This drawing is subject to change without notice.
  - C. Publication IPC-7351 is recommended for alternate designs.
  - D. Laser cutting apertures with trapezoidal walls and also rounding corners will offer better paste release. Customers should contact their board assembly site for stencil design recommendations. Refer to IPC-7525 for other stencil recommendations.
  - E. Customers should contact their board fabrication site for solder mask tolerances between and around signal pads.

## IMPORTANT NOTICE AND DISCLAIMER

TI PROVIDES TECHNICAL AND RELIABILITY DATA (INCLUDING DATA SHEETS), DESIGN RESOURCES (INCLUDING REFERENCE DESIGNS), APPLICATION OR OTHER DESIGN ADVICE, WEB TOOLS, SAFETY INFORMATION, AND OTHER RESOURCES "AS IS" AND WITH ALL FAULTS, AND DISCLAIMS ALL WARRANTIES, EXPRESS AND IMPLIED, INCLUDING WITHOUT LIMITATION ANY IMPLIED WARRANTIES OF MERCHANTABILITY, FITNESS FOR A PARTICULAR PURPOSE OR NON-INFRINGEMENT OF THIRD PARTY INTELLECTUAL PROPERTY RIGHTS.

These resources are intended for skilled developers designing with TI products. You are solely responsible for (1) selecting the appropriate TI products for your application, (2) designing, validating and testing your application, and (3) ensuring your application meets applicable standards, and any other safety, security, regulatory or other requirements.

These resources are subject to change without notice. TI grants you permission to use these resources only for development of an application that uses the TI products described in the resource. Other reproduction and display of these resources is prohibited. No license is granted to any other TI intellectual property right or to any third party intellectual property right. TI disclaims responsibility for, and you will fully indemnify TI and its representatives against, any claims, damages, costs, losses, and liabilities arising out of your use of these resources.

TI's products are provided subject to [TI's Terms of Sale](#) or other applicable terms available either on [ti.com](http://ti.com) or provided in conjunction with such TI products. TI's provision of these resources does not expand or otherwise alter TI's applicable warranties or warranty disclaimers for TI products.

TI objects to and rejects any additional or different terms you may have proposed.

Mailing Address: Texas Instruments, Post Office Box 655303, Dallas, Texas 75265  
Copyright © 2022, Texas Instruments Incorporated