



Thin-Film Balun

For 2300-2690MHz

TFSZ06052460-3310A2X

0.65x0.5mm [EIA 0202]*

* Dimensions Code JIS[EIA]

Thin-Film Balun

Conformity to RoHS Directive

For 2300-2690MHz

TFSZ06052460-3310A2X

SHAPES AND DIMENSIONS

[Top view]

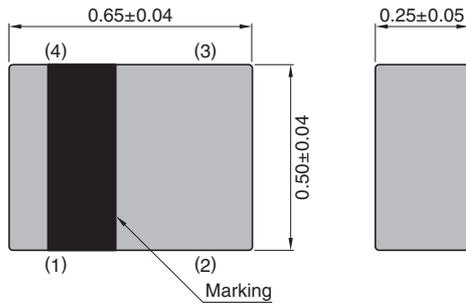

[Bottom view]

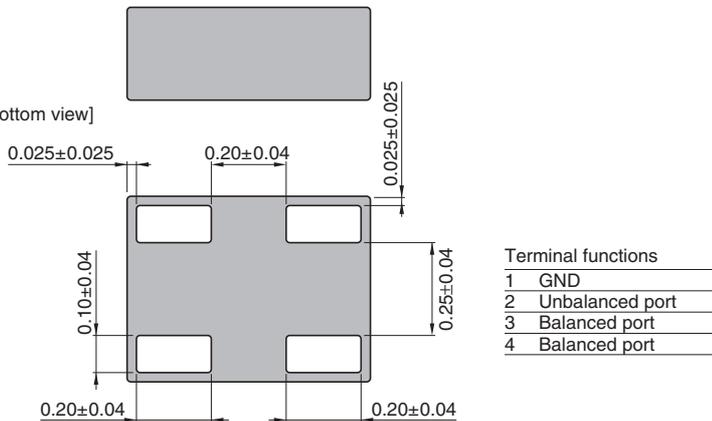

Terminal functions	
1	GND
2	Unbalanced port
3	Balanced port
4	Balanced port

Dimensions in mm

RECOMMENDED LAND PATTERN

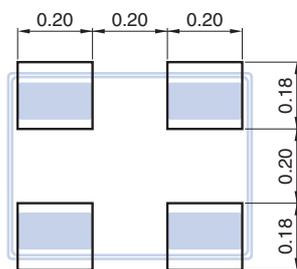

Dimensions in mm

Line width be designed to match 50Ω characteristic impedance depending on PCB material and thickness.

○ RoHS Directive Compliant Product: See the following for more details. <https://product.tdk.com/info/en/environment/rohs/index.html>

- All specifications are subject to change without notice.
- Before using these products, be sure to request the delivery specifications.

TFSZ06052460-3310A2X

ELECTRICAL CHARACTERISTICS

Item	Frequency Range (MHz)	Min.	Typ.	Max.
Unbalanced Port Characteristic Impedance (Ω)			50 (Nominal)	
Balanced Port Characteristic Impedance (Ω)			100 (Nominal)	
Return Loss at Unbalanced Port (dB)	2300 to 2690	10	—	—
Phase Balance (deg.)	2300 to 2690	170	—	190
Amplitude Balance (dB)	2300 to 2690	-2.5	—	2.5
Insertion Loss (dB)	2300 to 2690	—	—	0.55
	2300 to 2690	—	—	0.65 (-40 to +85°C)

· Ta: +25°C

TEMPERATURE RANGE

Operating temperature (°C)	Storage temperature (°C)
-40 to +85	-40 to +85

MSL

Moisture Sensitivity Level (MSL)
1

TFSZ06052460-3310A2X

FREQUENCY CHARACTERISTICS

INSERTION LOSS

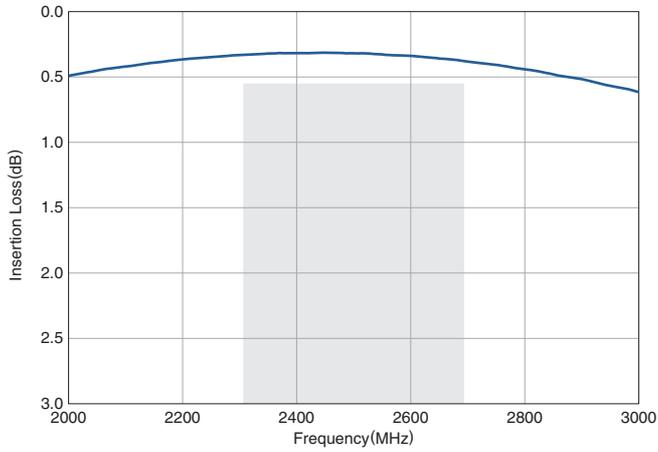

PHASE BALANCE

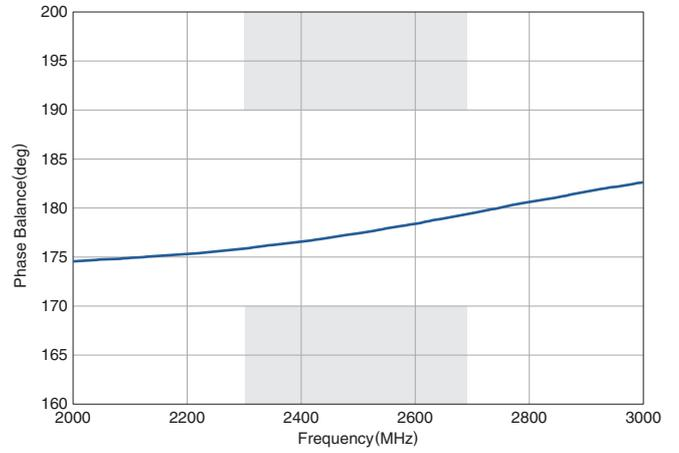

RETURN LOSS

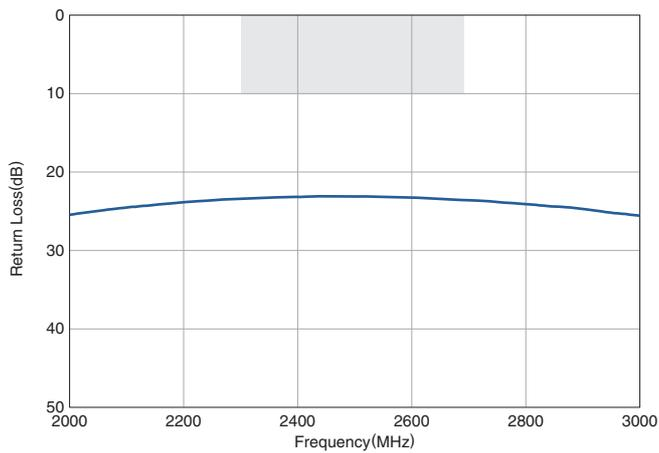

AMPLITUDE BALANCE

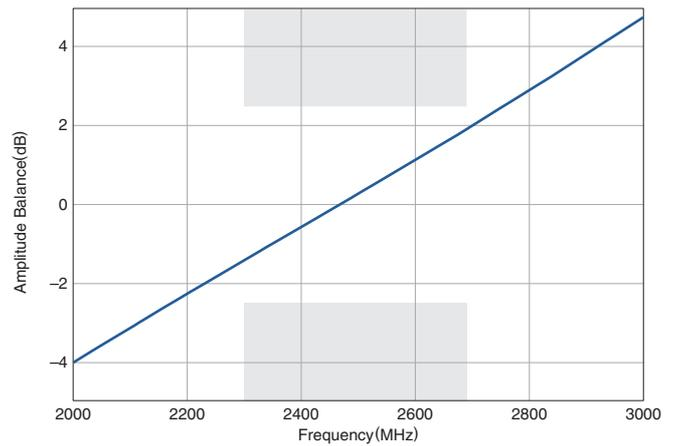

- All specifications are subject to change without notice.
- Before using these products, be sure to request the delivery specifications.

TFSZ06052460-3310A2X

PACKAGING STYLE

REEL DIMENSIONS

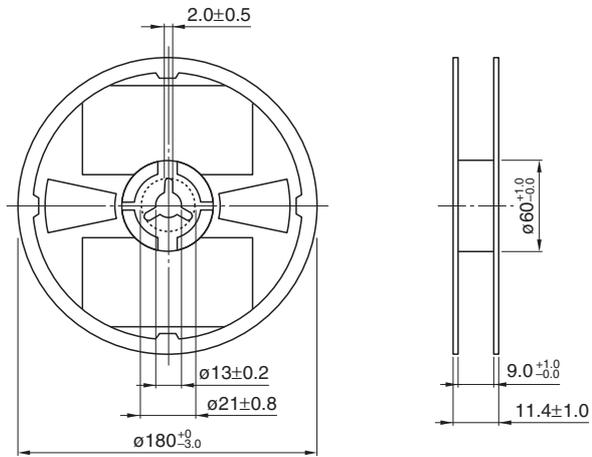

Dimensions in mm

TAPE DIMENSIONS

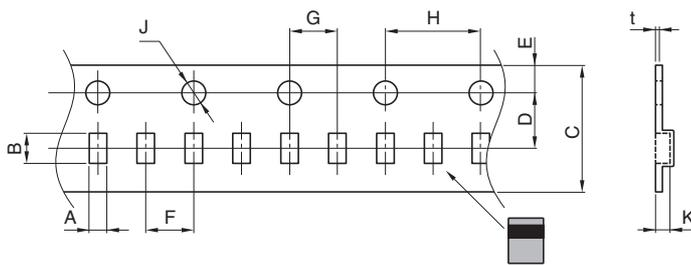

Dimensions in mm

A	B	C	D	E	F	G	H	J	K	t
0.63±0.03	0.81±0.03	8.0±0.2	3.5±0.05	1.75±0.1	2.0±0.05	2.0±0.05	4.0±0.1	1.5+0.1/-0	0.34±0.03	0.20±0.05

PACKAGE QUANTITY

Standard package quantity
(pieces/reel)

10,000

- All specifications are subject to change without notice.
- Before using these products, be sure to request the delivery specifications.

TFSZ06052460-3310A2X

RECOMMENDED REFLOW PROFILE

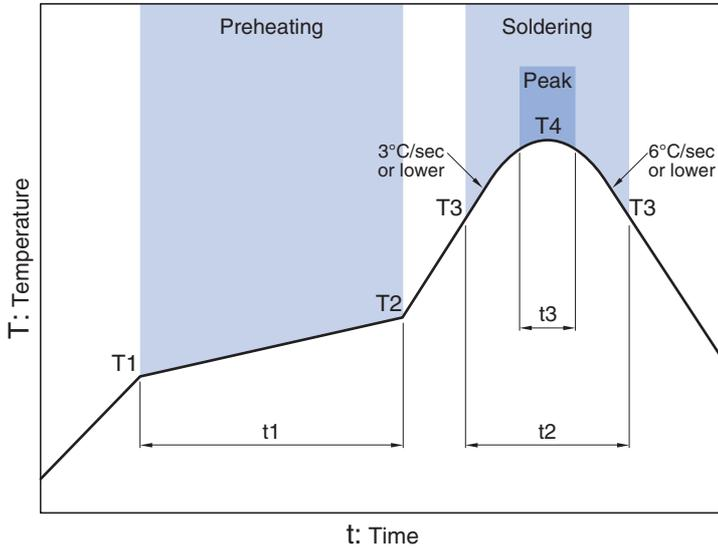

Preheating			Soldering			
Temp.	Time		Critical zone (T3 to T4)		Peak	
T1	T2	t1	Temp.	Time	Temp.	Time
T1	T2	t1	T3	t2	T4	t3*
150°C	200°C	60 to 120sec	217°C	60 to 120sec	240 to 260°C	30sec max.

* t3 : Time within 5°C of actual peak temperature
The maximum number of reflow is 3.

REMINDERS FOR USING THESE PRODUCTS

Before using these products, be sure to request the delivery specifications.

SAFETY REMINDERS

Please pay sufficient attention to the warnings for safe designing when using these products.

REMINDERS

The products listed on this catalog are intended for use in general electronic equipment (AV equipment, telecommunications equipment, home appliances, amusement equipment, computer equipment, personal equipment, office equipment, measurement equipment, industrial robots) under a normal operation and use condition.

The products are not designed or warranted to meet the requirements of the applications listed below, whose performance and/or quality require a more stringent level of safety or reliability, or whose failure, malfunction or trouble could cause serious damage to society, person or property.

Please understand that we are not responsible for any damage or liability caused by use of the products in any of the applications below or for any other use exceeding the range or conditions set forth in this catalog.

- | | |
|---|--|
| (1) Aerospace/Aviation equipment | (8) Public information-processing equipment |
| (2) Transportation equipment (cars, electric trains, ships, etc.) | (9) Military equipment |
| (3) Medical equipment | (10) Electric heating apparatus, burning equipment |
| (4) Power-generation control equipment | (11) Disaster prevention/crime prevention equipment |
| (5) Atomic energy-related equipment | (12) Safety equipment |
| (6) Seabed equipment | (13) Other applications that are not considered general-purpose applications |
| (7) Transportation control equipment | |

When using this product in general-purpose applications, you are kindly requested to take into consideration securing protection circuit/equipment or providing backup circuits, etc., to ensure higher safety.