



# GBJ25A thru GBJ25M

Glass Passivated Single-Phase Bridge Rectifiers  
Reverse Voltage 50 to 1000 Volts Forward Current 25.0 Amperes

## Features

- ◆ Thin Single In-Line package
- ◆ Ideal for printed circuit boards
- ◆ Glass passivated chip junction
- ◆ High surge current capability
- ◆ High case dielectric strength of 2500  $V_{RMS}$
- ◆ Plastic package has Underwriters Laboratory Flammability Classification 94V-0

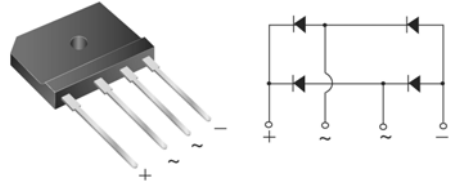

## Mechanical Data

- ◆ Case: GBJ(5S)  
Epoxy meets UL-94V-0 Flammability rating
- ◆ Terminals: Plated leads solderable per MIL-STD-750, Method 2026
- ◆ High temperature soldering guaranteed:  
260°C/10 seconds, 0.375 (9.5mm) lead length, 5lbs.(2.3kg) tension
- ◆ Polarity: As marked on body
- ◆ Mounting Torque: 10 cm-kg (8.8 inches-lbs) max.
- ◆ Recommended Torque: 5.7cm-kg (5 inches-lbs)

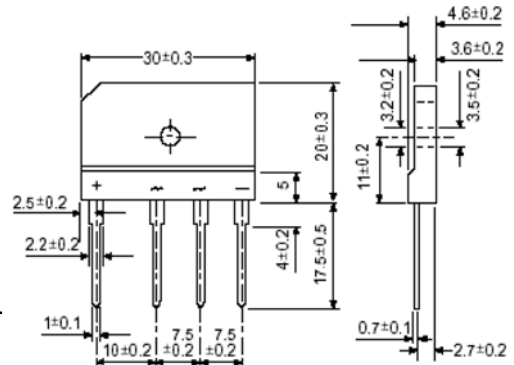

## Typical Applications

General purpose use in ac-to-dc bridge full wave rectification for Switching Power Supply, Home Appliances, Office Equipment, Industrial Automation applications

## Maximum Ratings and Electrical Characteristics

Rating at 25°C ambient temperature unless otherwise specified.

Parameter	Symbols	GBJ25A	GBJ25B	GBJ25D	GBJ25G	GBJ25J	GBJ25K	GBJ25M	Units
Maximum repetitive peak reverse voltage	$V_{RRM}$	50	100	200	400	600	800	1000	Volts
Maximum RMS voltage	$V_{RMS}$	35	70	140	280	420	560	700	Volts
Maximum DC blocking voltage	$V_{DC}$	50	100	200	400	600	800	1000	Volts
Maximum average forward rectified output current at $T_C=98^\circ\text{C}$ $T_A=25^\circ\text{C}$	$I_{F(AV)}$				25 <sup>(1)</sup> 3.5 <sup>(2)</sup>				Amps
Peak forward surge current, 8.3ms single half sine-wave superimposed on rated load (JEDEC Method)	$I_{FSM}$				350				Amps
Rating for fusing (t<8.3ms)	$I^2t$				500				A <sup>2</sup> sec
Maximum instantaneous forward voltage drop per leg at 12.5A	$V_F$				1.0				Volt
Maximum DC reverse current at rated DC blocking voltage per leg $T_A=25^\circ\text{C}$ $T_A=125^\circ\text{C}$	$I_R$				5 250				$\mu\text{A}$
Typical thermal resistance per leg	$R_{\theta JA}$ $R_{\theta JC}$				22 <sup>(2)</sup> 1.0 <sup>(1)</sup>				$^\circ\text{C}/\text{W}$
Dielectric strength (Terminals to case, AC 1 minute)	$V_{ISO}$				2500				Volts
Operating junction and storage temperature range	$T_J, T_{STG}$				-55 to +150				$^\circ\text{C}$

- Notes:**
1. Unit case mounted on 26.5x26.5x0.15cm thick Al plate heatsink
  2. Units mounted on P.C.B. without heatsink
  3. Recommended mounting position is to bolt down on heatsink with silicone thermal compound for maximum heat transfer with #6 screw

## RATINGS AND CHARACTERISTIC CURVES

( $T_A = 25^\circ\text{C}$  unless otherwise noted)

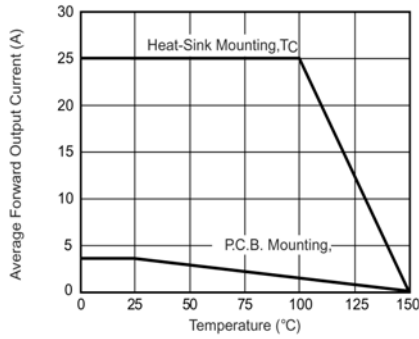

Figure 1. Derating Curve Output Rectified Current

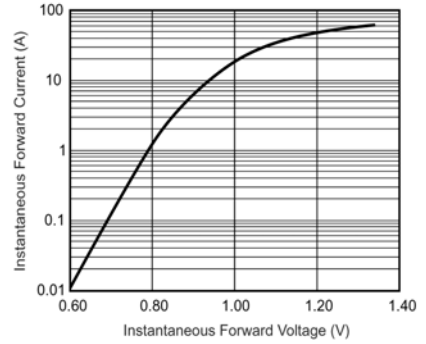

Figure 3. Typical Forward Characteristics Per Leg

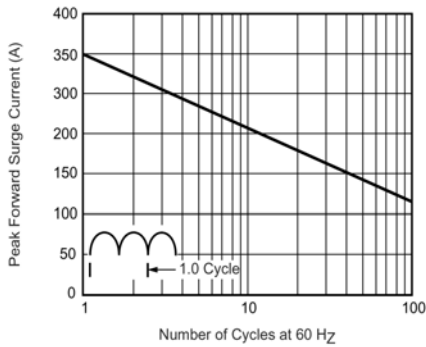

Figure 2. Maximum Non-Repetitive Peak Forward Surge Current Per Leg

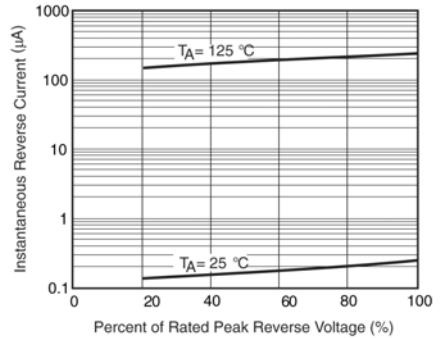

Figure 4. Typical Reverse Characteristics Per Leg

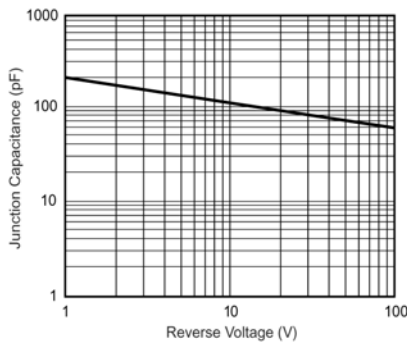

Figure 5. Typical Junction Capacitance Per Leg

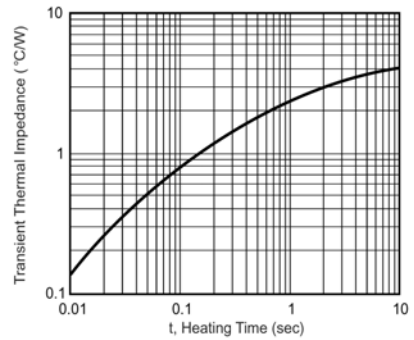

Figure 6. Typical Transient Thermal Impedance