

PWM CONTROL BOOST / FLYBACK SWITCHING REGULATOR IC

■GENERAL DESCRIPTION

NJU7600 is a high speed low voltage operation switching regulator control IC. It features a totem pole driver that can directly drive an external MOS-FET.

Internal soft-start function, Dead time control and timer latch function are included, requiring no external components. All parameters can be optimized by additional external components for design flexibility.

■PACKAGE OUTLINE



NJU7600M



NJU7600RB1

■FEATURES

- PWM switching control
- Operating Voltage 2.2V to 8V
- Wide Oscillator Range 300kHz to 1MHz
- Maximum Duty Cycle 90% typ.
- Quiescent Current 800uA typ.
- Soft-Start Function Internal : 16ms typ. or adjustable
- Dead Time Control
- Timer Latch for Short Circuit Protection
- C-MOS Technology
- Package Outline DMP8, TVSP8

■PIN CONFIGURATION

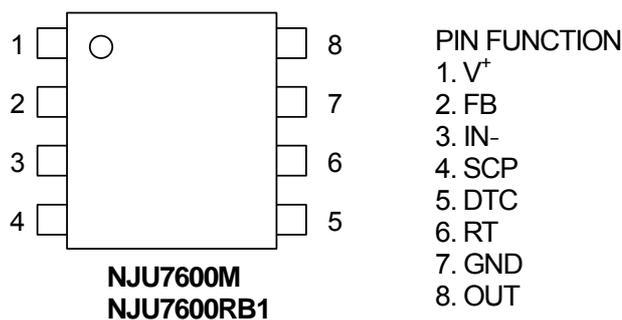

NJU7600

■BLOCK DIAGRAM

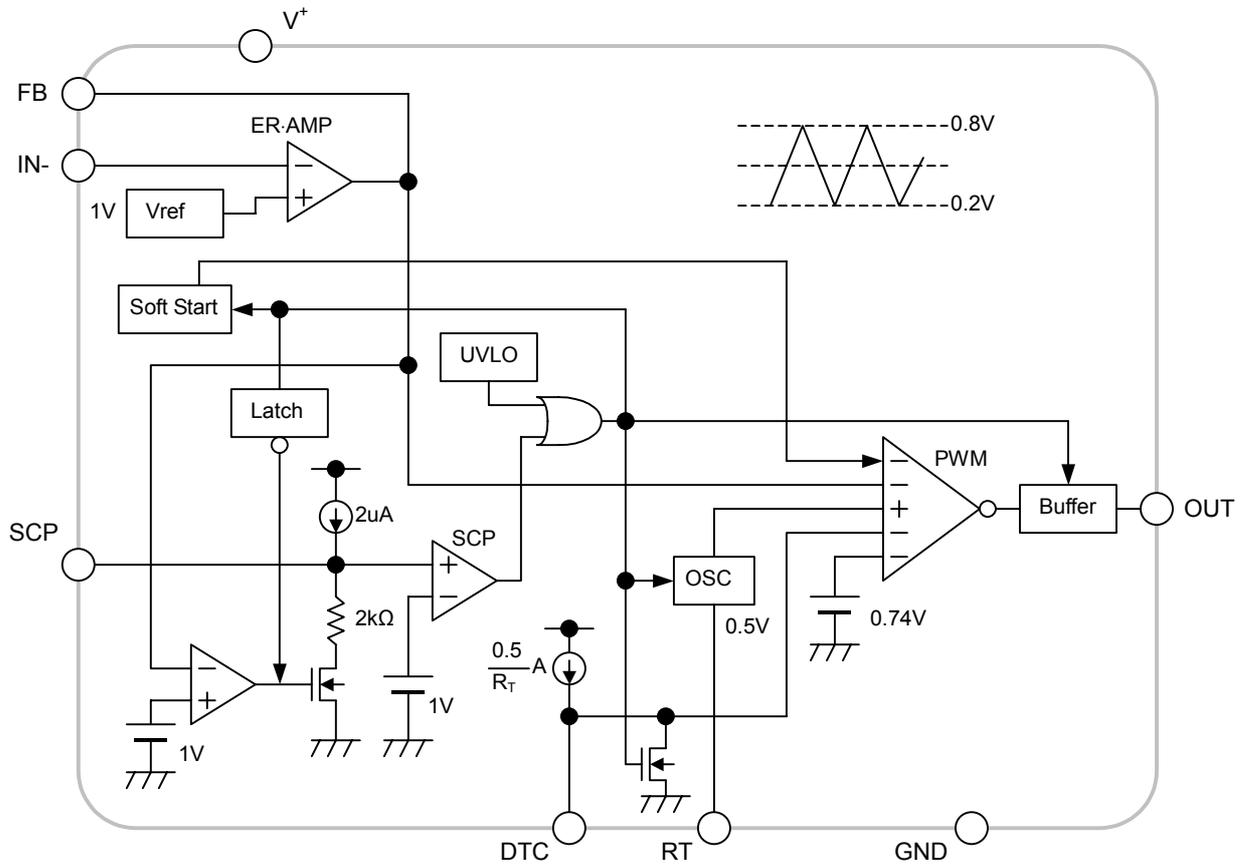

■ABSOLUTE MAXIMUM RATINGS (Ta=25°C)

PARAMETER	SYMBOL	MAXIMUM RATINGS	UNIT
Supply Voltage	V^+	+9	V
Output Pin Current	I_O	±50	mA
Power Dissipation	P_D	DMP8 :300 TVSP8 :320	mW
Operating Temperature Range	T_{OPR}	-40 ~ +85	°C
Storage Temperature Range	T_{STG}	-40 ~ +125	°C

■RECOMMENDED OPERATING CONDITIONS (Ta=25°C)

PARAMETER	SYMBOL	MIN.	TYP.	MAX.	UNIT
Operating Voltage	V^+	2.2	—	8	V
Oscillator Timing Resistor	R_T	30	47	120	kΩ
Oscillation Frequency	f_{OSC}	300	700	1,000	kHz

■ELECTRICAL CHARACTERISTICS ($V^+=3.3V$, $R_T=47k\Omega$, $T_a=25^\circ C$)

PARAMETER	SYMBOL	TEST CONDITION	MIN.	TYP.	MAX.	UNIT
Under Voltage Lockout Block						
ON Threshold Voltage	V_{T_ON}	$V^+ = L \rightarrow H$	1.9	2.0	2.1	V
OFF Threshold Voltage	V_{T_OFF}	$V^+ = H \rightarrow L$	1.8	1.9	2.0	V
Hysteresis Voltage	V_{HYS}		60	100	—	mV
Soft Start Block						
Soft Start Time	T_{SS}	$V_{T_ON} \rightarrow$ Duty=80%	8	16	24	ms
Short Circuit Protection Block						
Input Threshold Voltage	V_{T_PC}	FB Pin	0.95	1.00	1.05	V
Charge Current	I_{CHG}	$V_{SCP}=0V$	1.5	2	2.5	μA
Latch Mode ON Threshold Voltage	V_{T_LA}	SCP Pin	0.95	1.00	1.05	V
Latch Mode OFF Threshold Voltage	V_{T_LAOFF}	SCP Pin	0.2	0.45	0.7	V
Oscillator Block						
RT Pin Voltage	V_{RT}		-5%	0.5	+5%	V
Oscillation Frequency	f_{OSC}		630	700	770	kHz
Oscillate Supply Voltage Fluctuations	f_{DV}	$V^+=2.2V \sim 8V$	—	1	—	%
Oscillate Temperature Fluctuations	f_{DT}	$T_a=-40^\circ C \sim +85^\circ C$	—	3	—	%

NJU7600

■ELECTRICAL CHARACTERISTICS ($V^+=3.3V$, $R_T=47k\Omega$, $T_a=25^\circ C$)

PARAMETER	SYMBOL	TEST CONDITION	MIN.	TYP.	MAX.	UNIT
Error Amplifier Block						
Reference Voltage	V_B		-1.5%	1.00	+1.5%	V
Input Bias Current	I_B		-0.1	–	0.1	μA
Open Loop Gain	A_V		–	80	–	dB
Gain Bandwidth Product	G_B		–	1	–	MHz
Output Source Current	I_{OM+1}	$V_{FB}=1V$, $V_{IN-}=0.9V$	25	55	95	mA
	I_{OM+2}	$V_{FB}=1V$, $V_{IN-}=0.9V$, $V^+=2.2V$	4	9	16	mA
Output Sink Current	I_{OM-}	$V_{FB}=1V$, $V_{IN-}=1.1V$	0.10	0.16	0.22	mA
PWM Compare Block						
Input Threshold Voltage	V_{T0}	Duty=0%	0.16	0.22	0.28	V
	V_{T50}	Duty=50%	0.44	0.5	0.56	V
Maximum Duty Cycle	$M_{AX}D_{UTY1}$	$V_{FB}=0.9V$	85	90	95	%
	$M_{AX}D_{UTY2}$	$V_{FB}=0.9V$, $R_{DTC}=47k\Omega$	40	50	60	%
Output Block						
Output High Level ON Resistance	R_{OH}	$I_O=-20mA$	–	10	20	Ω
Output Low Level ON Resistance	R_{OL}	$I_O=+20mA$	–	5	10	Ω
General Characteristics						
Quiescent Current	I_{DD}	$R_L=Non\ Load$	–	800	1200	μA

■ TYPICAL APPLICATIONS

Boost Converter

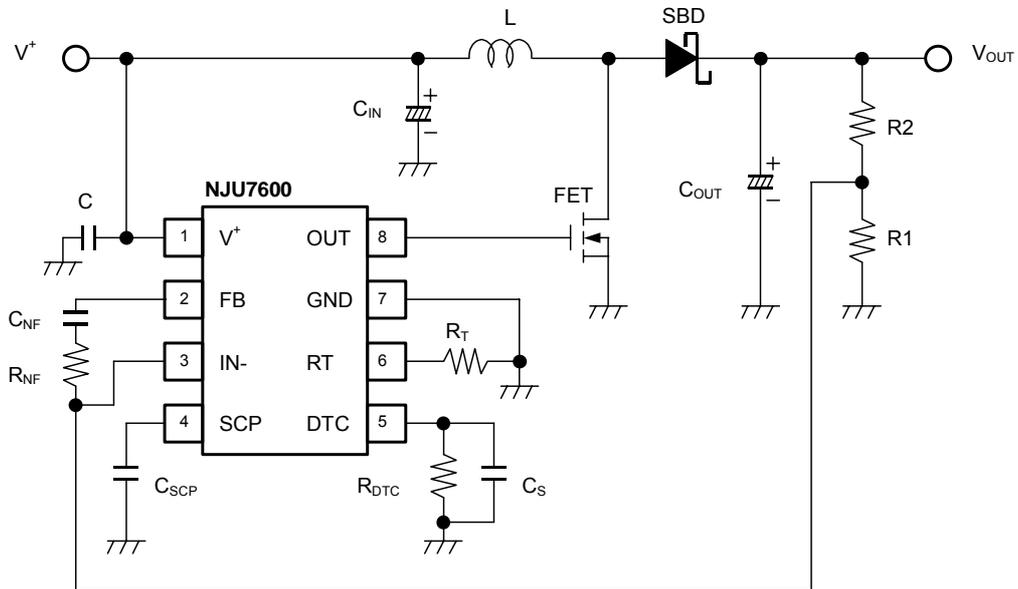

Flyback Converter

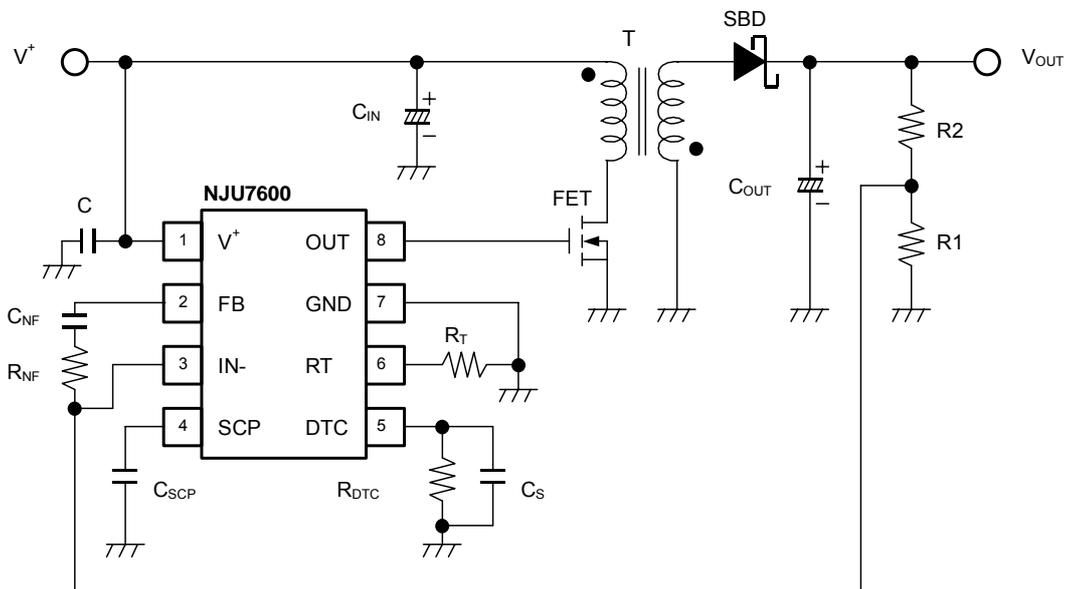

■ TYPICAL CHARACTERISTICS

Oscillation Frequency vs. Timing Resistance
($V^+ = 3.3V, T_a = 25^\circ C$)

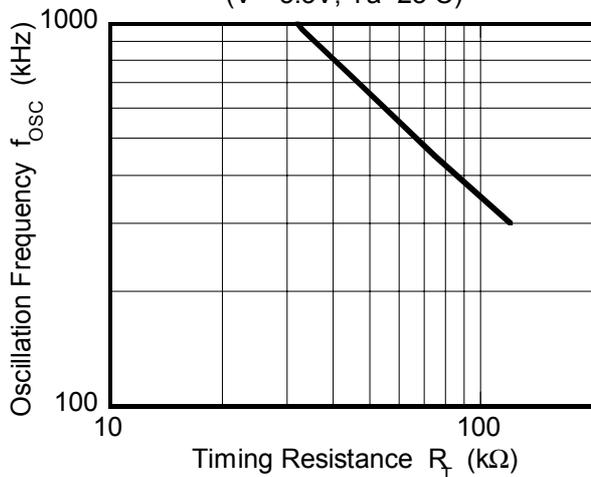

Maximum Duty Cycle vs. Oscillator Frequency
($V^+ = 3.3V, T_a = 25^\circ C$)

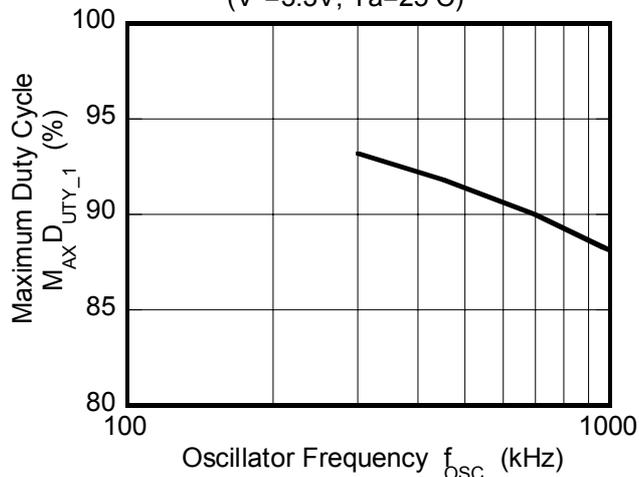

Oscillation Frequency vs. Operating Voltage
($R_T = 47k\Omega, T_a = 25^\circ C$)

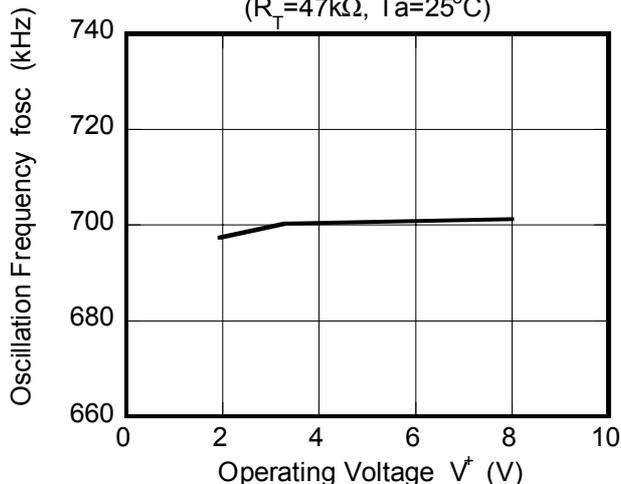

Duty Cycle vs. R_{DTC}

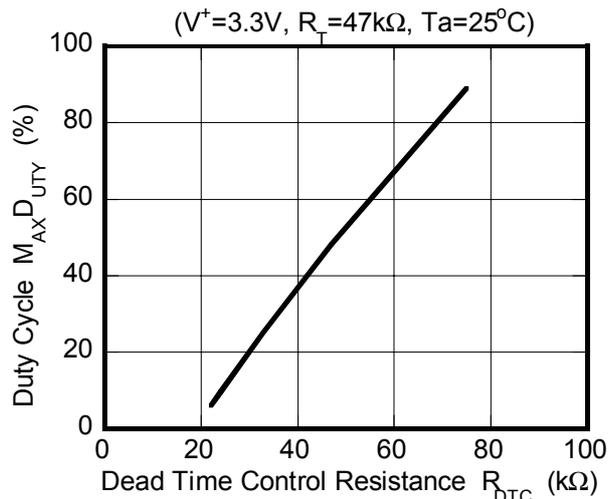

Reference Voltage vs. Operating Voltage
($V^+ = 3.3V, T_a = 25^\circ C$)

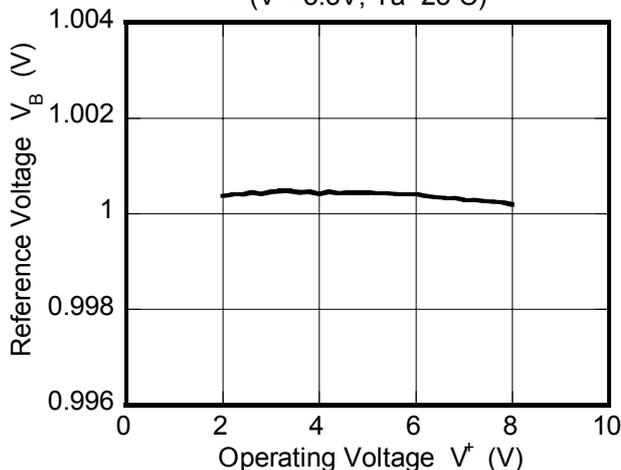

Quiescent Current vs. Operating Voltage
($R_T = 47k\Omega, R_L = \text{Non Load}, T_a = 25^\circ C$)

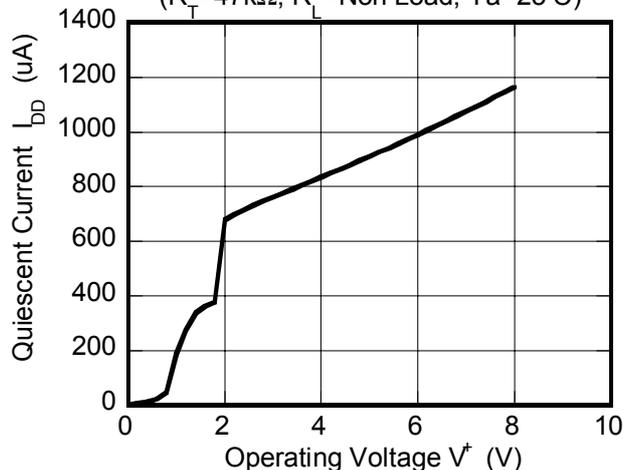

■ TYPICAL CHARACTERISTICS

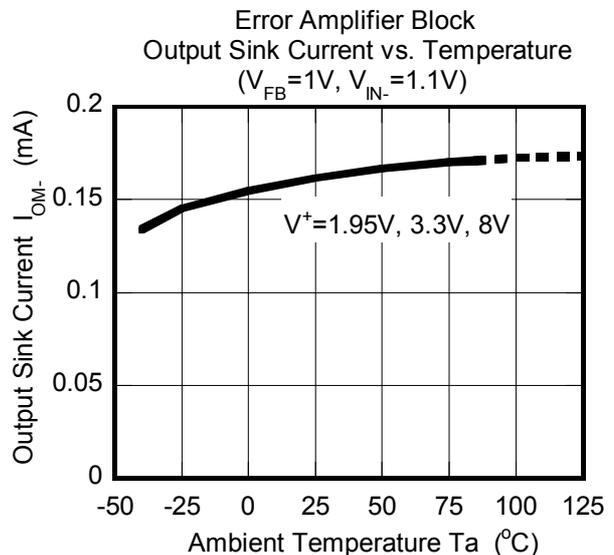
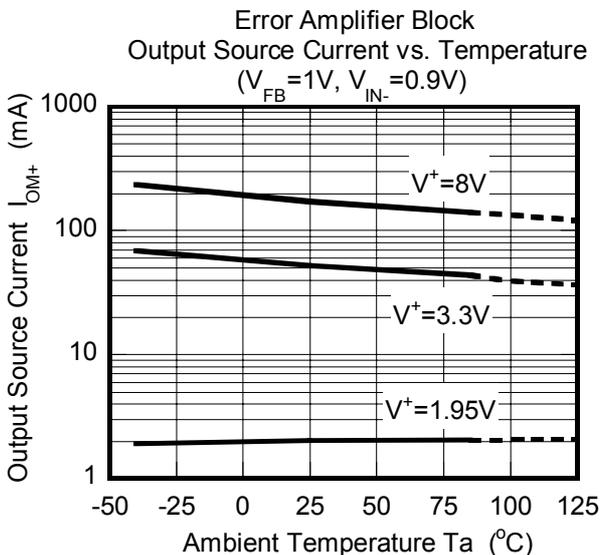
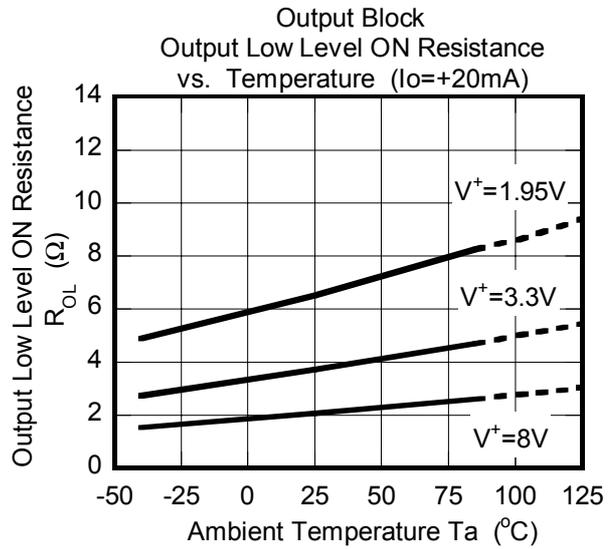
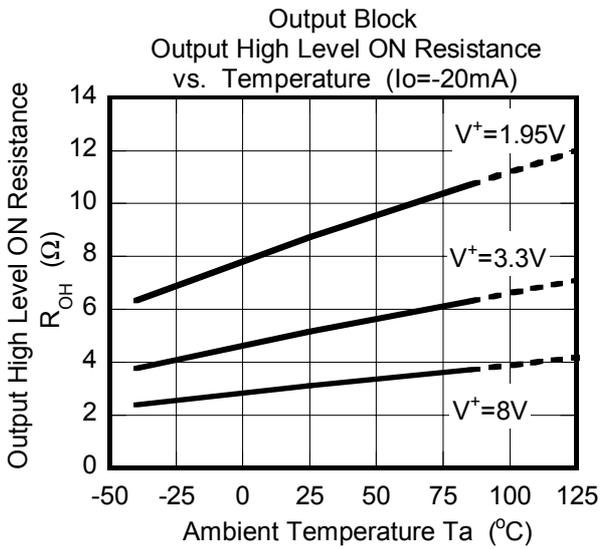
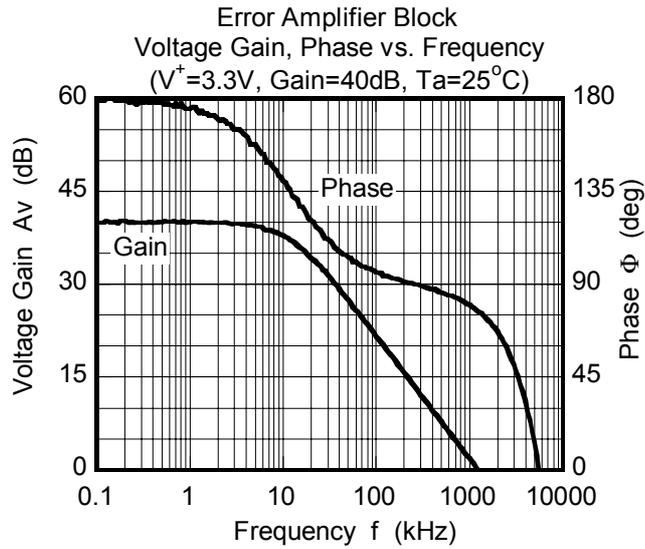

■ TYPICAL CHARACTERISTICS

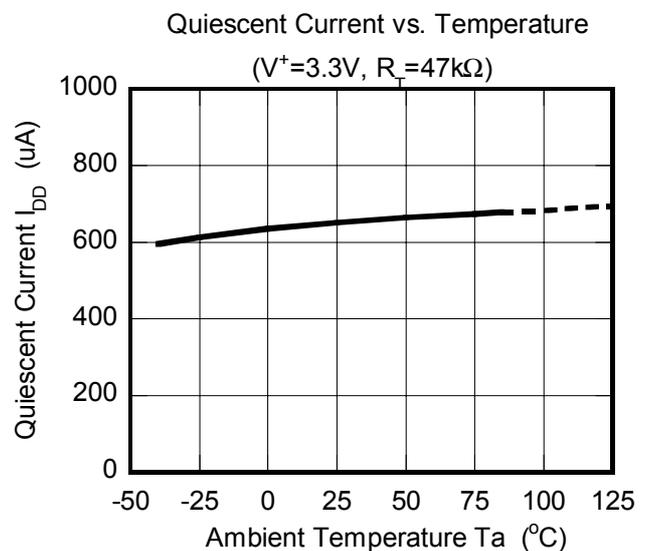
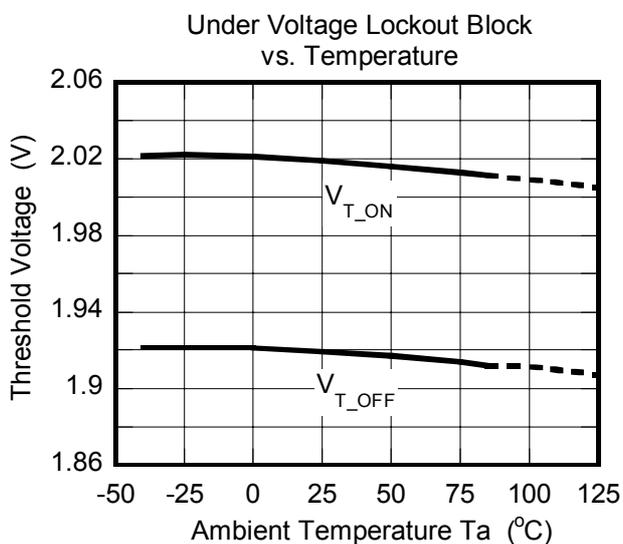
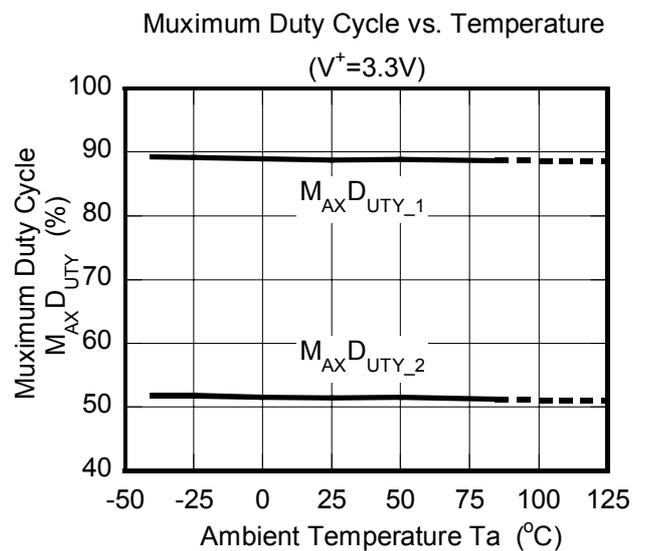
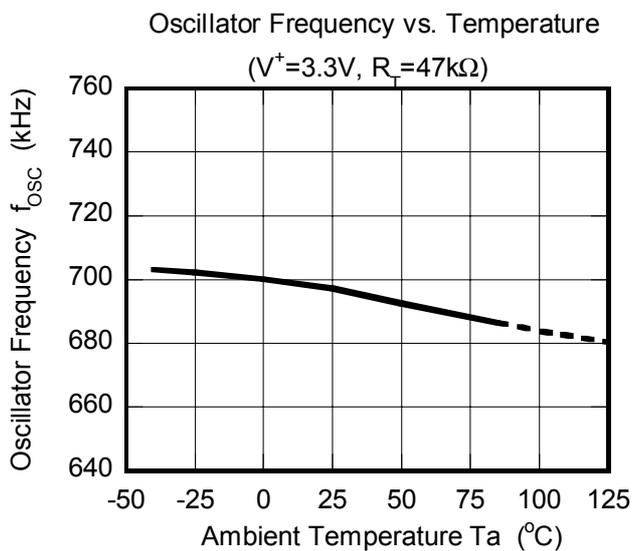
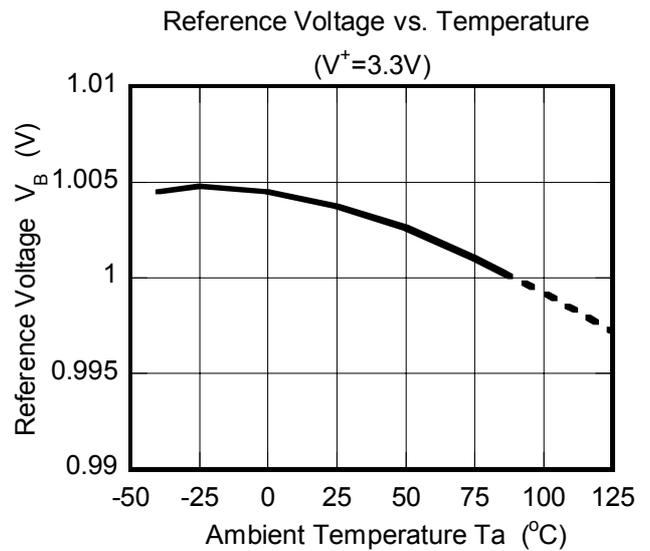
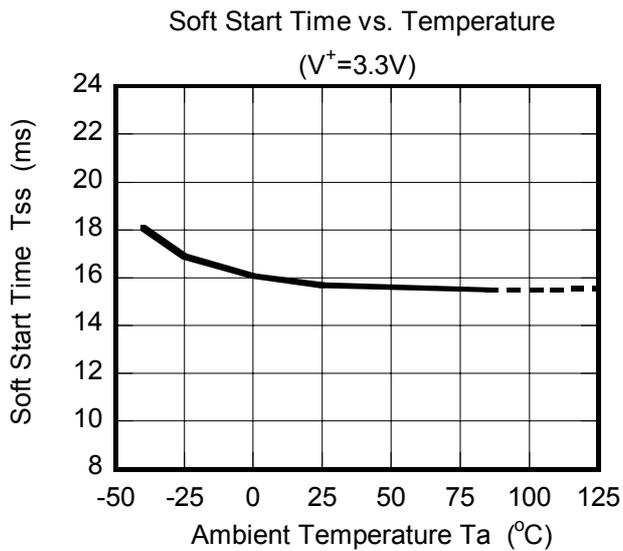

MEMO

[CAUTION]

The specifications on this databook are only given for information, without any guarantee as regards either mistakes or omissions. The application circuits in this databook are described only to show representative usages of the product and not intended for the guarantee or permission of any right including the industrial rights.