

# MOSFET – N-Channel, UltraFET Trench

100 V, 22 A, 23 mΩ

## FDMS3672

### General Description

UltraFET devices combine characteristics that enable benchmark efficiency in power conversion applications. Optimized for  $R_{DS(on)}$ , low ESR, low total and Miller gate charge, these devices are ideal for high frequency DC to DC converters.

### Features

- Max  $R_{DS(on)}$  = 23 mΩ at  $V_{GS} = 10\text{ V}$ ,  $I_D = 7.4\text{ A}$
- Max  $R_{DS(on)}$  = 29 mΩ at  $V_{GS} = 6\text{ V}$ ,  $I_D = 6.6\text{ A}$
- Typ  $Q_g = 31\text{ nC}$  at  $V_{GS} = 10\text{ V}$
- Low Miller Charge
- Optimized Efficiency at High Frequencies
- This Device is Pb-Free, Halide Free and RoHS Compliant

### Applications

- DC-DC Conversion

### ABSOLUTE MAXIMUM RATINGS ( $T_A = 25^\circ\text{C}$ unless otherwise noted.)

Symbol	Parameter	Value	Unit
$V_{DS}$	Drain-Source Voltage	100	V
$V_{GS}$	Gate-Source Voltage	±20	V
$I_D$	Drain Current		A
	– Continuous (Package Limited) $T_C = 25^\circ\text{C}$	22	
	– Continuous (Silicon Limited) $T_C = 25^\circ\text{C}$	41	
	– Continuous (Note 1a) $T_A = 25^\circ\text{C}$	7.4	
	– Pulsed	30	
$P_D$	Power Dissipation $T_C = 25^\circ\text{C}$	78	W
	Power Dissipation (Note 1a) $T_A = 25^\circ\text{C}$	2.5	
$T_J, T_{STG}$	Operating and Storage Junction Temperature Range	–55 to +150	$^\circ\text{C}$

Stresses exceeding those listed in the Maximum Ratings table may damage the device. If any of these limits are exceeded, device functionality should not be assumed, damage may occur and reliability may be affected.

### THERMAL CHARACTERISTICS ( $T_A = 25^\circ\text{C}$ unless otherwise noted.)

Symbol	Parameter	Value	Unit
$R_{\theta JC}$	Thermal Resistance, Junction to Case	1.6	$^\circ\text{C}/\text{W}$
$R_{\theta JA}$	Thermal Resistance, Junction to Ambient (Note 1a)	53	$^\circ\text{C}/\text{W}$

$V_{DS}$	$R_{DS(on)}$ MAX	$I_D$ MAX
100 V	23 mΩ @ 10 V	22 A
	29 mΩ @ 6 V	

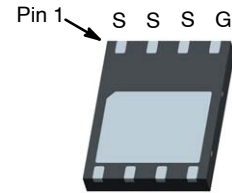

D D D D  
Bottom

WDFN8 5x6, 1.27P  
Power 56  
CASE 506DP

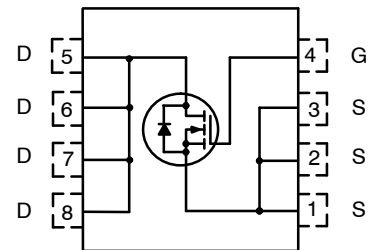

N-CHANNEL MOSFET

### MARKING DIAGRAM

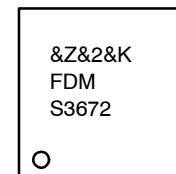

- &Z = Assembly Location
- &2 = Date Code
- &K = Lot Run Traceability Code
- FDMS3672 = Specific Device Code

### ORDERING INFORMATION

Device	Package	Shipping†
FDMS3672	WDFN8 (Pb-Free, Halide Free)	3000 / Tape & Reel

†For information on tape and reel specifications, including part orientation and tape sizes, please refer to our Tape and Reel Packaging Specification Brochure, [BRD8011/D](#).

# FDMS3672

## ELECTRICAL CHARACTERISTICS (T<sub>J</sub> = 25°C unless otherwise noted)

Symbol	Parameter	Test Condition	Min	Typ	Max	Unit
--------	-----------	----------------	-----	-----	-----	------

### OFF CHARACTERISTICS

BV <sub>DSS</sub>	Drain to Source Breakdown Voltage	I <sub>D</sub> = 250 μA, V <sub>GS</sub> = 0 V	100	–	–	V
ΔBV <sub>DSS</sub> /ΔT <sub>J</sub>	Breakdown Voltage Temperature Coefficient	I <sub>D</sub> = 250 μA, referenced to 25°C	–	104	–	mV/°C
I <sub>DSS</sub>	Zero Gate Voltage Drain Current	V <sub>DS</sub> = 80 V, V <sub>GS</sub> = 0 V	–	–	1	μA
		V <sub>DS</sub> = 80 V, V <sub>GS</sub> = 0 V, T <sub>J</sub> = 55°C	–	–	10	
I <sub>GSS</sub>	Gate to Source Leakage Current	V <sub>GS</sub> = ±20 V, V <sub>DS</sub> = 0 V	–	–	±100	nA

### ON CHARACTERISTICS

V <sub>GS(th)</sub>	Gate to Source Threshold Voltage	V <sub>GS</sub> = V <sub>DS</sub> , I <sub>D</sub> = 250 μA	2.0	3.1	4.0	V
ΔV <sub>GS(th)</sub> /ΔT <sub>J</sub>	Gate to Source Threshold Voltage Temperature Coefficient	I <sub>D</sub> = 250 μA, referenced to 25°C	–	–11	–	mV/°C
R <sub>DS(on)</sub>	Static Drain to Source On Resistance	V <sub>GS</sub> = 10 V, I <sub>D</sub> = 7.4 A	–	19	23	mΩ
		V <sub>GS</sub> = 6 V, I <sub>D</sub> = 6.6 A	–	24	29	
		V <sub>GS</sub> = 10 V, I <sub>D</sub> = 7.4 A, T <sub>J</sub> = 125°C	–	33	40	
g <sub>FS</sub>	Forward Transconductance	V <sub>DS</sub> = 10 V, I <sub>D</sub> = 7.4 A	–	20	–	S

### DYNAMIC CHARACTERISTICS

C <sub>iss</sub>	Input Capacitance	V <sub>DS</sub> = 50 V, V <sub>GS</sub> = 0 V, f = 1 MHz	–	2015	2680	pF
C <sub>oss</sub>	Output Capacitance		–	210	280	pF
C <sub>rss</sub>	Reverse Transfer Capacitance		–	90	135	pF
R <sub>g</sub>	Gate Resistance	f = 1 MHz	–	1.3	–	Ω

### SWITCHING CHARACTERISTICS

t <sub>d(on)</sub>	Turn-On Delay Time	V <sub>DD</sub> = 50 V, I <sub>D</sub> = 7.4 A, V <sub>GS</sub> = 10 V, R <sub>GEN</sub> = 6 Ω	–	23	37	ns
t <sub>r</sub>	Rise Time		–	11	20	ns
t <sub>d(off)</sub>	Turn-Off Delay Time		–	36	58	ns
t <sub>f</sub>	Fall Time		–	8	16	ns
Q <sub>g</sub>	Total Gate Charge at 10 V	V <sub>GS</sub> = 0 V to 10 V, V <sub>DD</sub> = 50 V, I <sub>D</sub> = 7.4 A	–	31	44	nC
Q <sub>g</sub>	Total Gate Charge at 4.5 V	V <sub>GS</sub> = 0 V to 4.5 V, V <sub>DD</sub> = 50 V, I <sub>D</sub> = 7 A	–	–	–	nC
Q <sub>gs</sub>	Gate to Source Charge	V <sub>DD</sub> = 50 V, I <sub>D</sub> = 7.4 A	–	9.5	–	nC
Q <sub>gd</sub>	Gate to Drain "Miller" Charge	V <sub>DD</sub> = 50 V, I <sub>D</sub> = 7.4 A	–	8	–	nC

### DRAIN-SOURCE DIODE CHARACTERISTICS

V <sub>SD</sub>	Source to Drain Diode Forward Voltage	V <sub>GS</sub> = 0 V, I <sub>S</sub> = 7.4 A (Note 2)	–	0.8	1.2	V
t <sub>rr</sub>	Reverse Recovery Time	I <sub>F</sub> = 7.4 A, di/dt = 100 A/μs	–	52	78	ns
Q <sub>rr</sub>	Reverse Recovery Charge		–	101	152	nC

Product parametric performance is indicated in the Electrical Characteristics for the listed test conditions, unless otherwise noted. Product performance may not be indicated by the Electrical Characteristics if operated under different conditions.

#### NOTES:

- R<sub>θJA</sub> is determined with the device mounted on a 1 in<sup>2</sup> pad 2 oz copper pad on a 1.5 × 1.5 in. board of FR-4 material. R<sub>θJC</sub> is guaranteed by design while R<sub>θCA</sub> is determined by the user's board design.

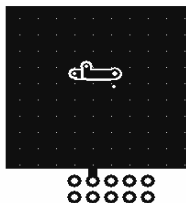

- 50°C/W when mounted on a 1 in<sup>2</sup> pad of 2 oz copper.



- 125°C/W when mounted on a minimum pad of 2 oz copper.

- Pulse Test: Pulse Width < 300 μs, Duty cycle < 2.0%.

TYPICAL CHARACTERISTICS

( $T_J = 25^\circ\text{C}$  unless otherwise noted)

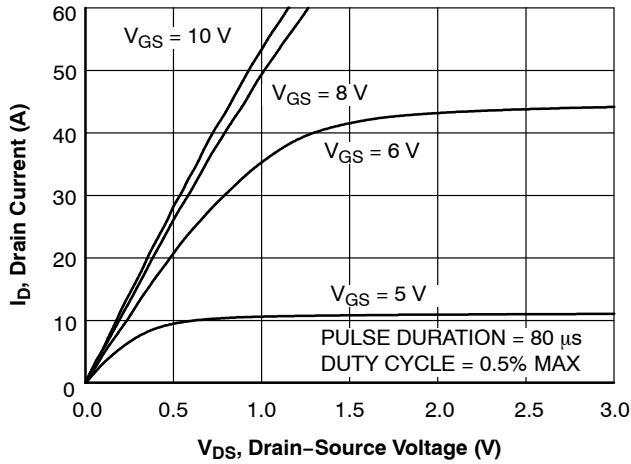

Figure 1. On-Region Characteristics

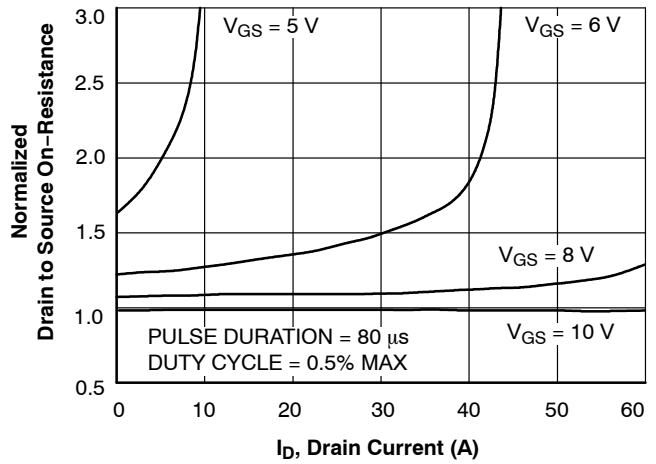

Figure 2. Normalized On-Resistance vs. Drain Current and Gate Voltage

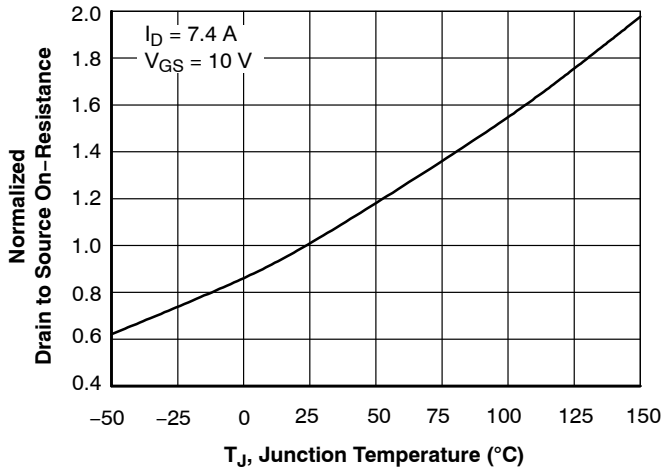

Figure 3. Normalized On-Resistance vs. Junction Temperature

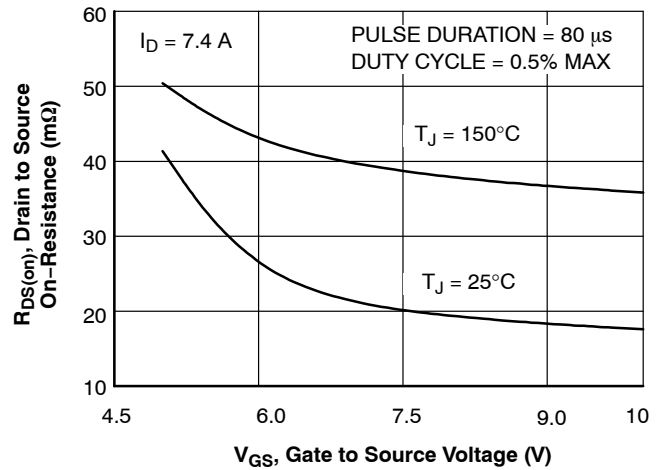

Figure 4. On-Resistance vs. Gate to Source Voltage

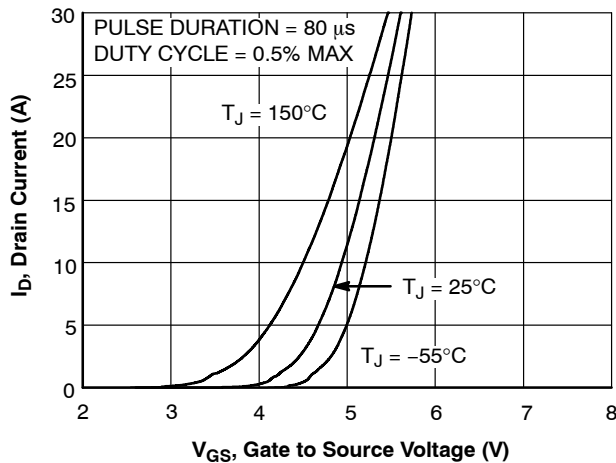

Figure 5. Transfer Characteristics

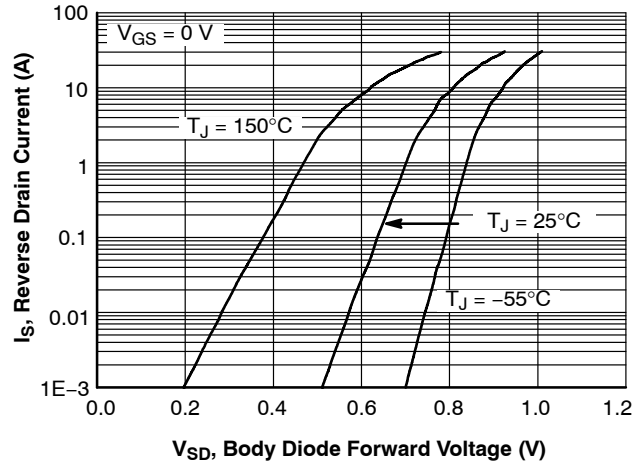

Figure 6. Source to Drain Diode Forward Voltage vs. Source Current

TYPICAL CHARACTERISTICS (CONTINUED)

( $T_J = 25^\circ\text{C}$  unless otherwise noted)

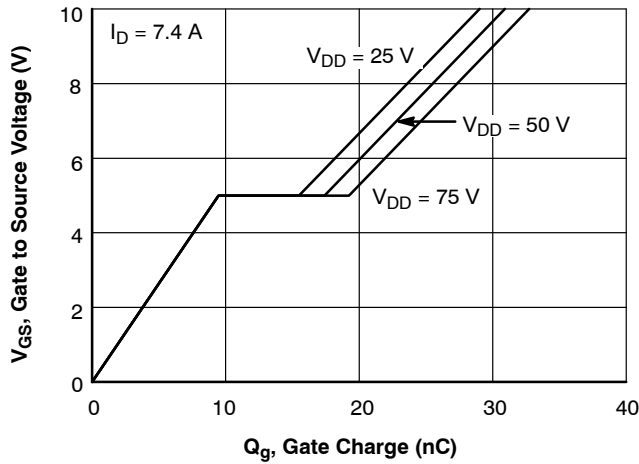

Figure 7. Gate Charge Characteristics

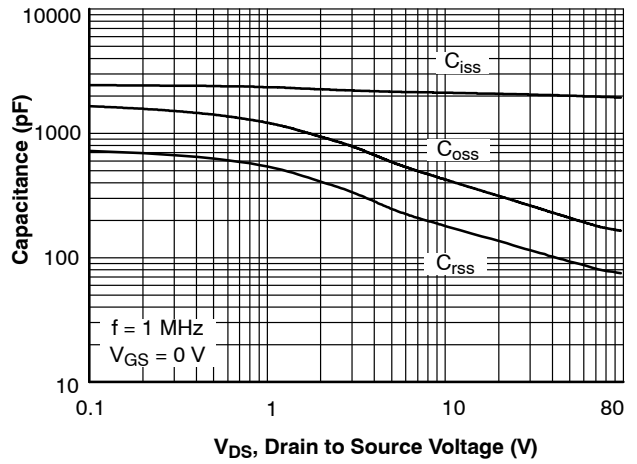

Figure 8. Capacitance vs. Drain to Source Voltage

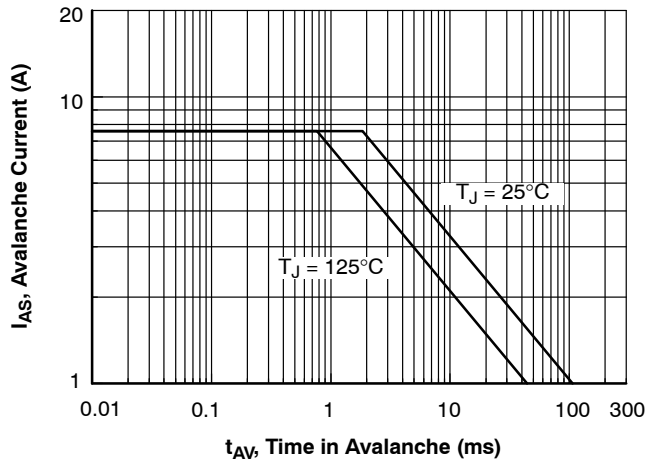

Figure 9. Unclamped Inductive Switching Capability

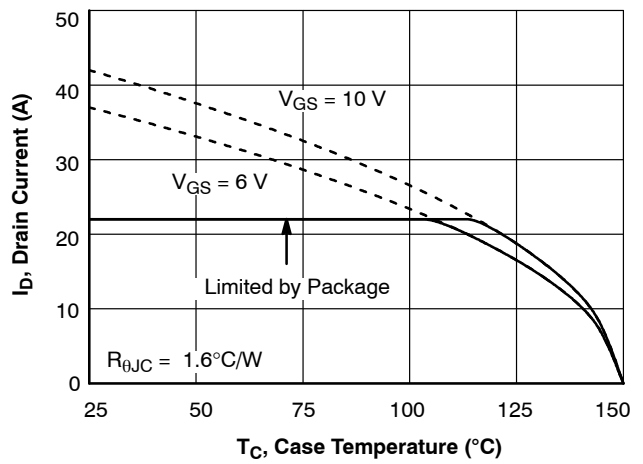

Figure 10. Maximum Continuous Drain Current vs. Case Temperature

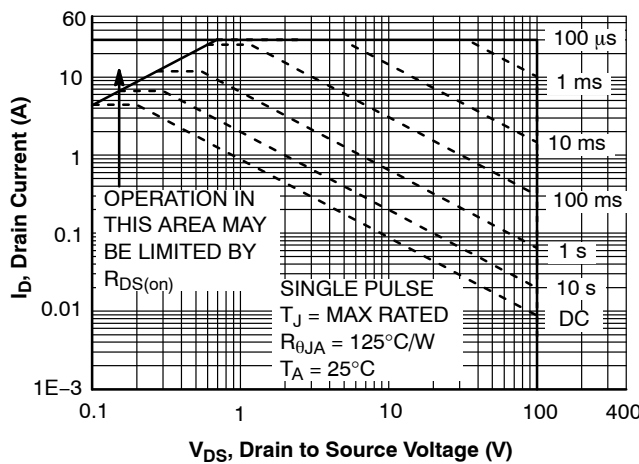

Figure 11. Forward Bias Safe Operating Area

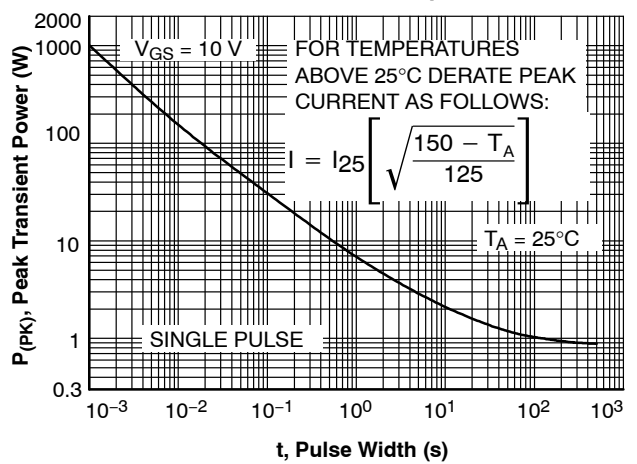

Figure 12. Single Pulse Maximum Power Dissipation

TYPICAL CHARACTERISTICS (CONTINUED)

( $T_J = 25^\circ\text{C}$  unless otherwise noted)

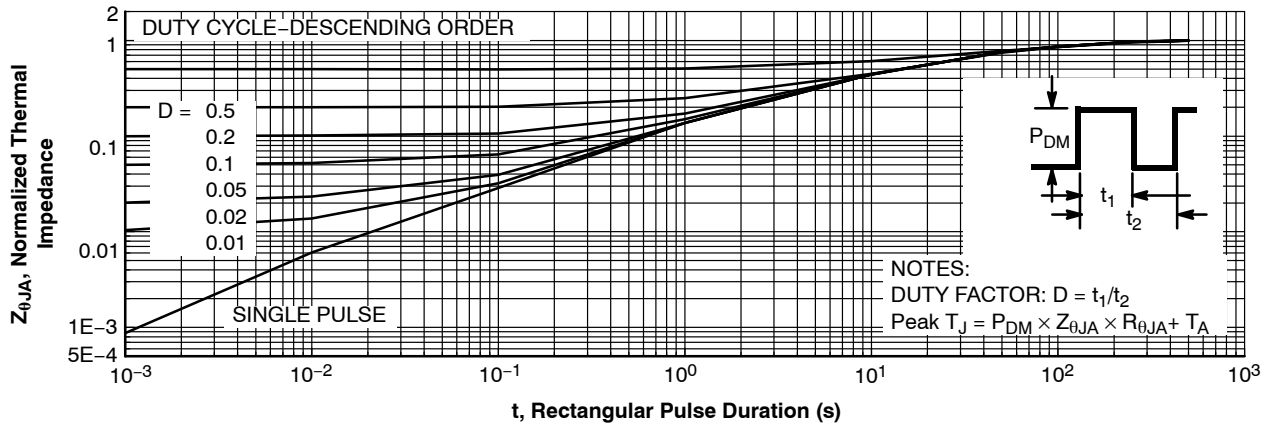

Figure 13. Transient Thermal Response Curve

# MECHANICAL CASE OUTLINE

## PACKAGE DIMENSIONS

ON Semiconductor®



**WDFN8 5x6, 1.27P**  
CASE 506DP  
ISSUE O

DATE 31 AUG 2016

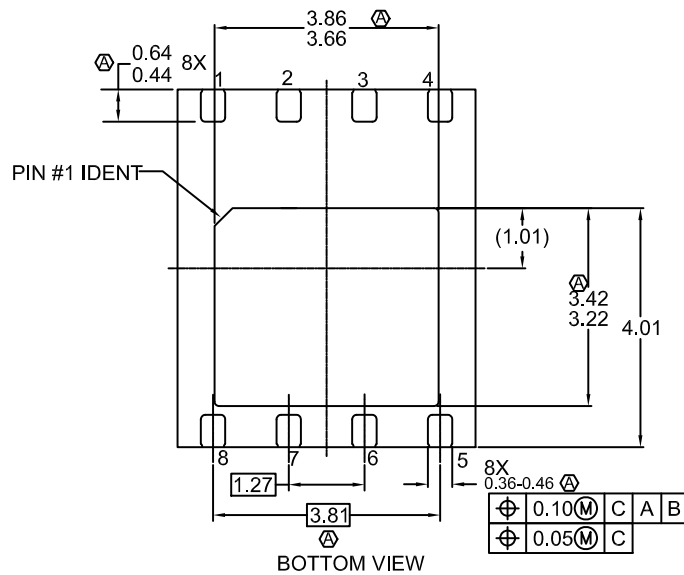
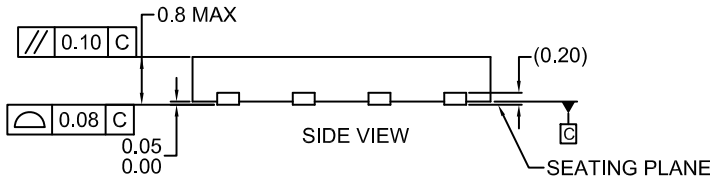
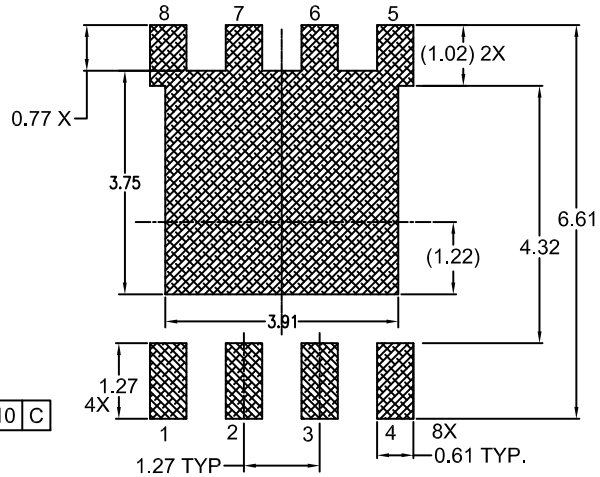
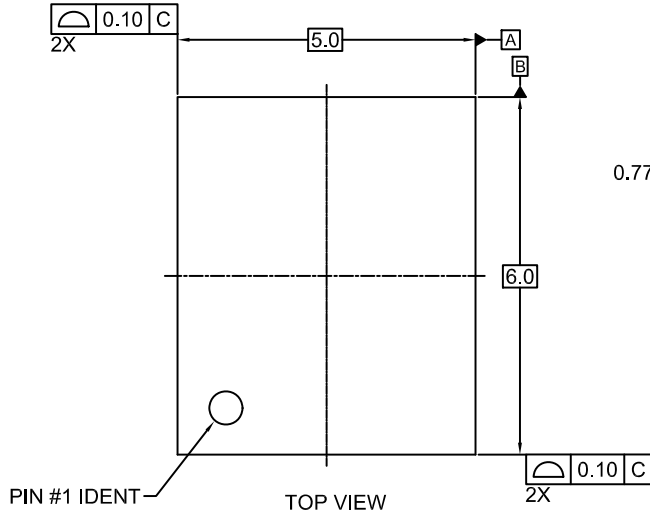

**NOTES:**

- Ⓐ DOES NOT FULLY CONFORM TO JEDEC REGISTRATION, MO-229.
- B. DIMENSIONS ARE IN MILLIMETERS.
- C. DIMENSIONS AND TOLERANCES PER ASME Y14.5M, 1994
- D. TERMINALS 5,6,7 AND 8 ARE TIED TO THE EXPOSED PADDLE

<b>DOCUMENT NUMBER:</b>	<b>98AON13598G</b>	Electronic versions are uncontrolled except when accessed directly from the Document Repository. Printed versions are uncontrolled except when stamped "CONTROLLED COPY" in red.
<b>DESCRIPTION:</b>	<b>WDFN8 5X6, 1.27P</b>	<b>PAGE 1 OF 1</b>

ON Semiconductor and are trademarks of Semiconductor Components Industries, LLC dba ON Semiconductor or its subsidiaries in the United States and/or other countries. ON Semiconductor reserves the right to make changes without further notice to any products herein. ON Semiconductor makes no warranty, representation or guarantee regarding the suitability of its products for any particular purpose, nor does ON Semiconductor assume any liability arising out of the application or use of any product or circuit, and specifically disclaims any and all liability, including without limitation special, consequential or incidental damages. ON Semiconductor does not convey any license under its patent rights nor the rights of others.

**onsemi**, **Onsemi**, and other names, marks, and brands are registered and/or common law trademarks of Semiconductor Components Industries, LLC dba "**onsemi**" or its affiliates and/or subsidiaries in the United States and/or other countries. **onsemi** owns the rights to a number of patents, trademarks, copyrights, trade secrets, and other intellectual property. A listing of **onsemi**'s product/patent coverage may be accessed at [www.onsemi.com/site/pdf/Patent-Marking.pdf](http://www.onsemi.com/site/pdf/Patent-Marking.pdf). **onsemi** reserves the right to make changes at any time to any products or information herein, without notice. The information herein is provided "as-is" and **onsemi** makes no warranty, representation or guarantee regarding the accuracy of the information, product features, availability, functionality, or suitability of its products for any particular purpose, nor does **onsemi** assume any liability arising out of the application or use of any product or circuit, and specifically disclaims any and all liability, including without limitation special, consequential or incidental damages. Buyer is responsible for its products and applications using **onsemi** products, including compliance with all laws, regulations and safety requirements or standards, regardless of any support or applications information provided by **onsemi**. "Typical" parameters which may be provided in **onsemi** data sheets and/or specifications can and do vary in different applications and actual performance may vary over time. All operating parameters, including "Typicals" must be validated for each customer application by customer's technical experts. **onsemi** does not convey any license under any of its intellectual property rights nor the rights of others. **onsemi** products are not designed, intended, or authorized for use as a critical component in life support systems or any FDA Class 3 medical devices or medical devices with a same or similar classification in a foreign jurisdiction or any devices intended for implantation in the human body. Should Buyer purchase or use **onsemi** products for any such unintended or unauthorized application, Buyer shall indemnify and hold **onsemi** and its officers, employees, subsidiaries, affiliates, and distributors harmless against all claims, costs, damages, and expenses, and reasonable attorney fees arising out of, directly or indirectly, any claim of personal injury or death associated with such unintended or unauthorized use, even if such claim alleges that **onsemi** was negligent regarding the design or manufacture of the part. **onsemi** is an Equal Opportunity/Affirmative Action Employer. This literature is subject to all applicable copyright laws and is not for resale in any manner.

## ADDITIONAL INFORMATION

### TECHNICAL PUBLICATIONS:

Technical Library: [www.onsemi.com/design/resources/technical-documentation](http://www.onsemi.com/design/resources/technical-documentation)  
onsemi Website: [www.onsemi.com](http://www.onsemi.com)

### ONLINE SUPPORT: [www.onsemi.com/support](http://www.onsemi.com/support)

For additional information, please contact your local Sales Representative at [www.onsemi.com/support/sales](http://www.onsemi.com/support/sales)