

SMD Power Inductor CDRH2D14

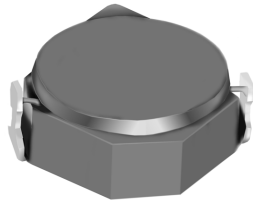

Halogen Free



Description

- Ferrite drum core construction.
- Magnetically shielded.
- L × W × H: 3.2 × 3.2 × 1.55mm Max.
- Product weight: 46mg(Ref.)
- Moisture Sensitivity Level: 1
- RoHS compliance.
- Halogen Free available.

Environmental Data

- Operating temperature range: -40°C~+100°C (including coil's self temperature rise)
- Storage temperature range: -40°C~+100°C
- Solder reflow temperature: 260 °C peak.

Packaging

- Carrier tape and reel packaging
- 7.0" diameter reel
- 1000pcs per reel

Applications

- Ideally used in Mobilephone, PDA, MP3, DSC/DVC, etc. as DC-DC converter inductors.

Dimension - [mm]

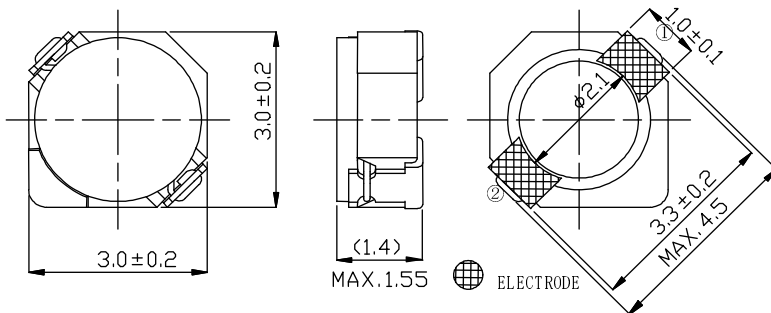

Land pattern and Schematics - [mm]

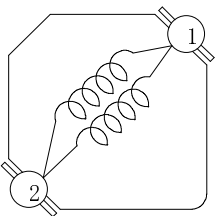
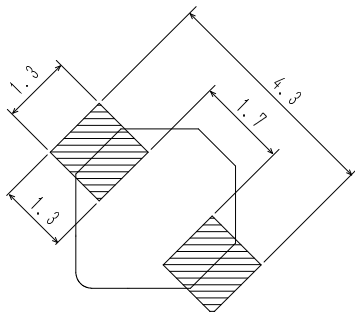

(0.21 μ H ~ 2.7 μ H)

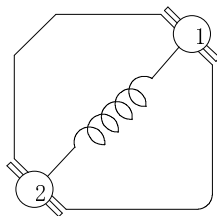

(3.3 μ H ~ 12 μ H)

SMD Power Inductor CDRH2D14



Electrical Characteristics

Part Name	Stamp	Inductance (μ H) [within] ※1	D.C.R. (m Ω) Max. (Typ.) (at 20°C)	Saturation Current (A) ※2		Temperature Rise Current (A) ※3
				at 20°C	at 100°C	
CDRH2D14NP-R21NC	N	0.21 \pm 35%	21(16)	3.80	2.70	4.74
CDRH2D14NP-R36NC	P	0.36 \pm 35%	26(20)	3.25	2.55	4.10
CDRH2D14NP-R60NC	Q	0.60 \pm 35%	33(25)	2.20	1.75	3.45
CDRH2D14NP-R82NC	R	0.82 \pm 35%	39(30)	2.10	1.68	2.85
CDRH2D14NP-1R2NC	S	1.2 \pm 30%	49(38)	1.95	1.35	2.75
CDRH2D14NP-1R5NC	A	1.5 \pm 30%	63(50)	1.80	1.20	2.00
CDRH2D14NP-1R8NC	B	1.8 \pm 30%	75(60)	1.65	1.10	1.80
CDRH2D14NP-2R2NC	C	2.2 \pm 30%	94(75)	1.50	1.00	1.60
CDRH2D14NP-2R7NC	D	2.7 \pm 30%	106(85)	1.35	0.90	1.40
CDRH2D14NP-3R3NC	E	3.3 \pm 30%	125(100)	1.20	0.82	1.24
CDRH2D14NP-3R9NC	F	3.9 \pm 30%	138(110)	1.10	0.75	1.12
CDRH2D14NP-4R7NC	G	4.7 \pm 30%	169(135)	1.00	0.68	1.00
CDRH2D14NP-5R6NC	H	5.6 \pm 30%	188(150)	0.95	0.60	0.98
CDRH2D14NP-6R8NC	J	6.8 \pm 30%	213(170)	0.85	0.56	0.92
CDRH2D14NP-8R2NC	K	8.2 \pm 30%	281(225)	0.80	0.51	0.80
CDRH2D14NP-100NC	L	10 \pm 30%	294(235)	0.70	0.46	0.76
CDRH2D14NP-120NC	M	12 \pm 30%	394(315)	0.62	0.42	0.64

※1 Inductance measuring condition: at 100 kHz.

※2 Saturation current: The DC current at which the inductance decreases to 65% of its nominal value.

※3 Temperature rise current: The DC current at which the temperature rise is $\Delta T = 40^\circ\text{C}$. ($T_a = 20^\circ\text{C}$)

SMD Power Inductor CDRH2D14



Saturation Current & Temperature Rise Graph

— L (20°C) — L (100°C) — ΔT

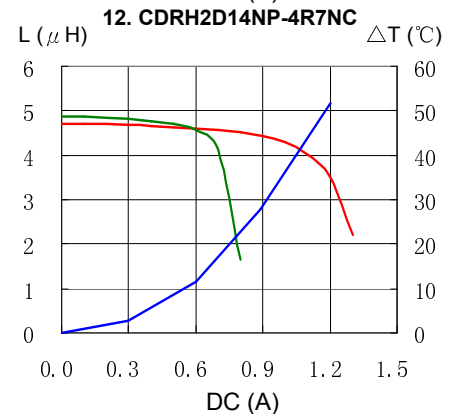
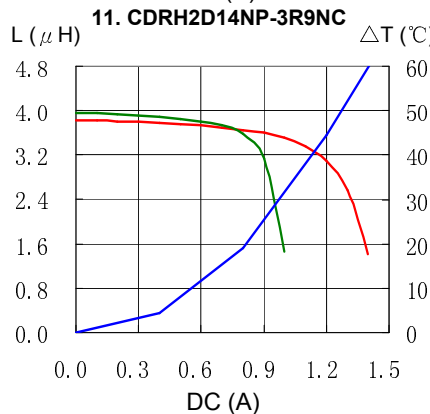
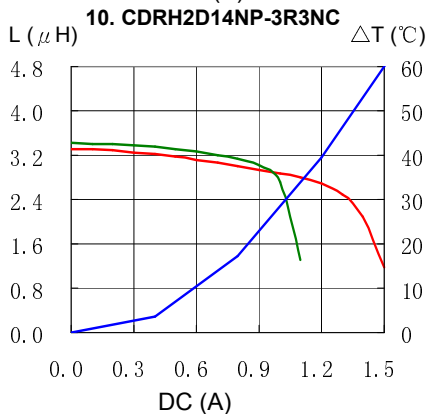
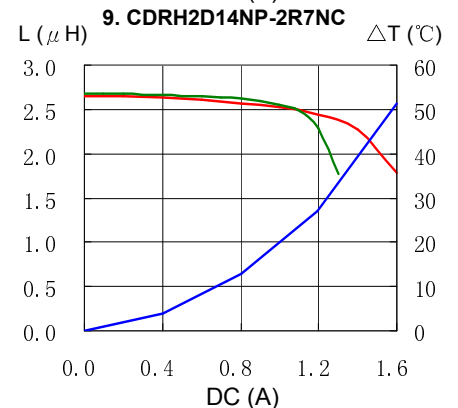
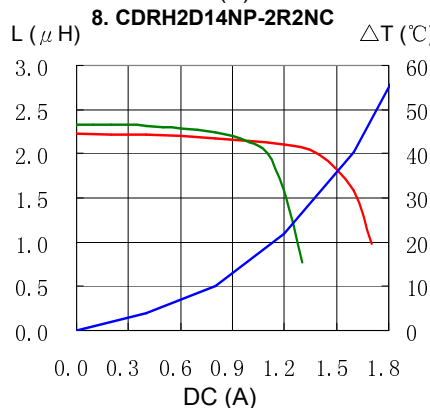
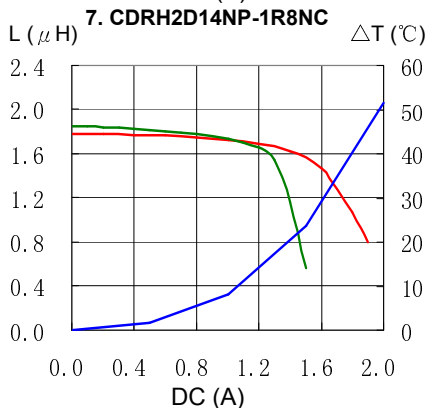
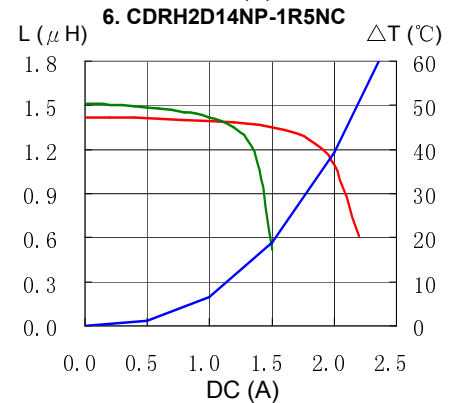
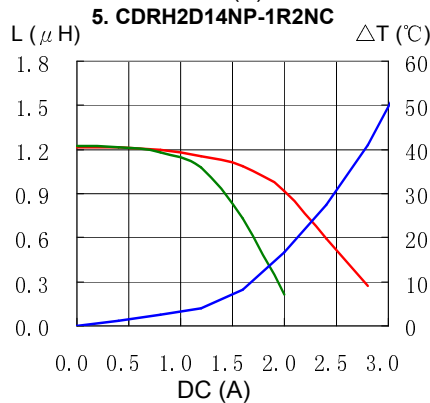
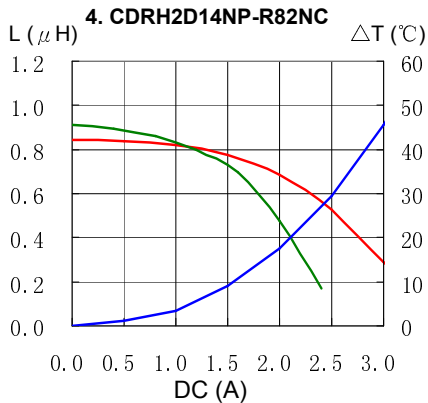
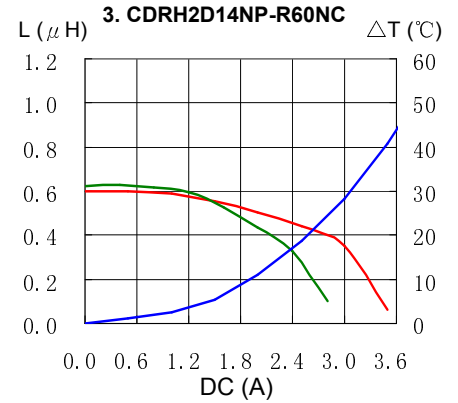
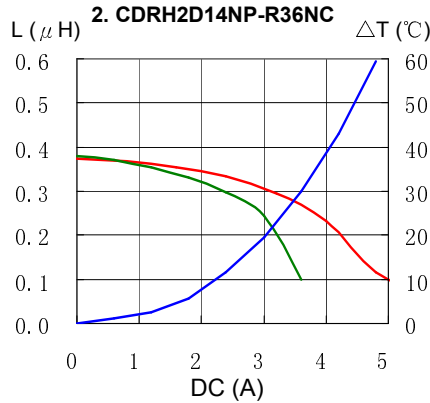
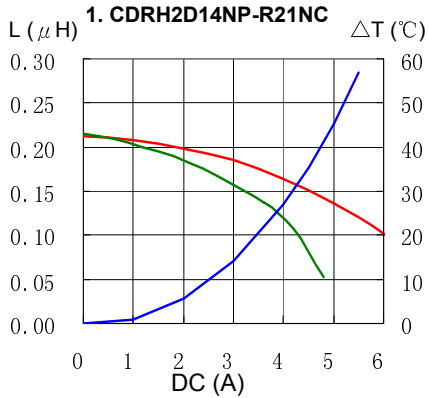

SMD Power Inductor CDRH2D14



Saturation Current & Temperature Rise Graph

— L (20°C) — L (100°C) — ΔT

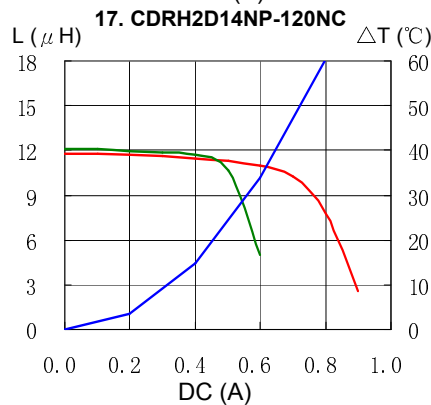
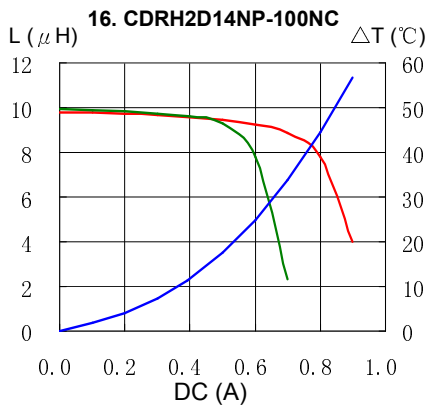
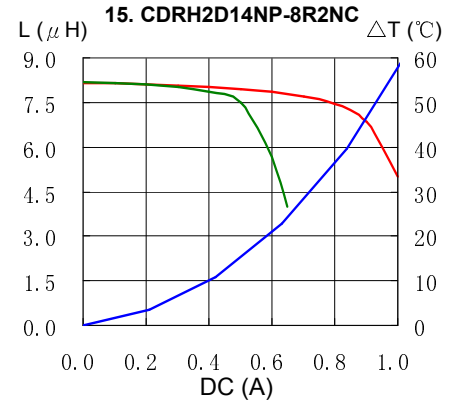
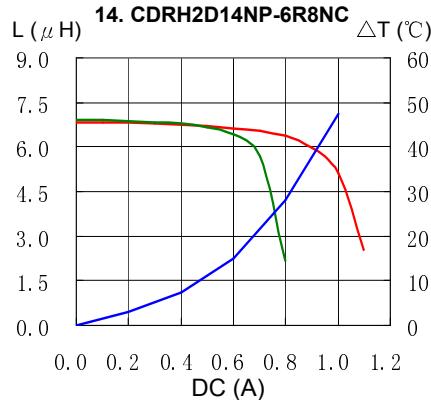
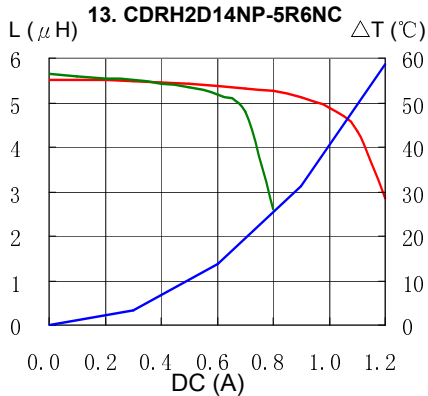

Solder Reflow Condition

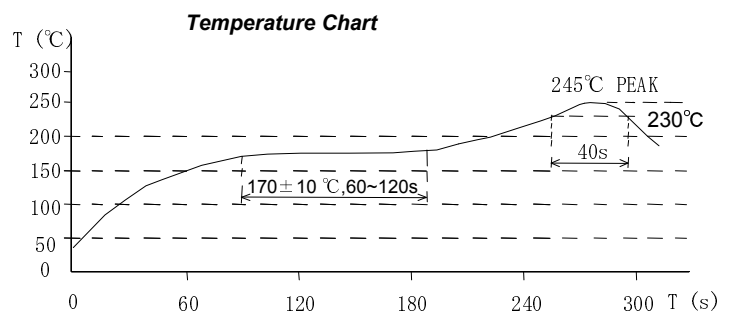
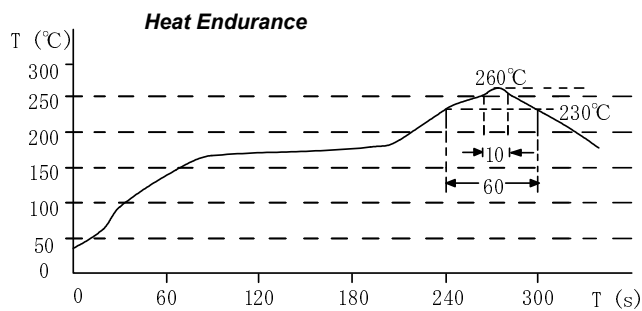

Please refer to the sales offices on our website - <http://www.sumida.com>

Hong Kong
Tel.+852-2880-6781
FAX.+852-2565-9600
sales@hk.sumida.com
Saitama(Japan)
Tel.+81-48-691-7300
FAX.+81-48-691-7340
sales@jp.sumida.com
Chicago
Tel.+1-847-545-6700
FAX. +1-847-545-6720
sales@us.sumida.com

Shanghai
Tel.+86-21-5836-3299
FAX.+86-21-5836-3266
shanghai.sales@cn.sumida.com
Seoul
Tel.+82-2-6237-0777
FAX.+82-2-6237-0778
sales@kr.sumida.com
Oberzell
Tel.+49-8591-937-0
FAX. +49-8591-937-103
contact@eu.sumida.com

Shenzhen
Tel.+86-755-8291-0228
FAX.+86-755-8291-0338
shenzhen.sales@cn.sumida.com
Singapore
Tel.+65-6296-3388
FAX.+65-6841-4426
sales@sg.sumida.com
Neumarkt
Tel.+49-9181-4509-110
FAX. +49-9181-4509-310
infocomp@eu.sumida.com

Taipei
Tel.+886-2-8751-2737
FAX.+886-2-8751-2738
sales@tw.sumida.com
San Jose
Tel.+1-408-321-9660
FAX.+1-408-321-9308
sales@us.sumida.com