

PQxxxENAHZPH Series

Low Voltage Operation, Compact Surface Mount type Low Power-Loss Voltage Regulators

■ Features

1. Low voltage operation
(Minimum operating voltage: 2.35V)
2. Output current : 1.5A
3. Low dissipation current
(Dissipation current at no load: MAX. 2mA
Output OFF-state dissipation current: MAX. 5μA)
4. Compliant Ceramic capacitors
5. Built-in ON/OFF function
6. Built-in overcurrent and overheat protection functions
7. Correspond to flow soldering
8. RoHS directive compliant

■ Applications

1. Personal computers and peripheral equipment
2. Power supplies for various digital electronic equipment such as DVD player or STB

■ Model Line-up

Output Voltage (TYP.)	Model No.
1.5V	PQ015ENAHZPH
1.8V	PQ018ENAHZPH
2.5V	PQ025ENAHZPH
3.3V	PQ033ENAHZPH

■ Absolute Maximum Ratings

(Ta=25°C)

Parameter	Symbol	Rating	Unit
*1 Input voltage	V _{IN}	10	V
*1 Output control voltage	V _C	10	V
Output current	I _O	1.5	A
*2 Power dissipation	P _d	8	W
*3 Junction temperature	T _J	150	°C
Operating temperature	T _{opr}	-40 to +85	°C
Storage temperature	T _{stg}	-40 to +150	°C
Soldering temperature	T _{sol}	260(10s)	°C

*1 All are open except GND and applicable terminals.

*2 P_d: With infinite heat sink

*3 There is case that over heat protection operates at the temperature T_J: 125°C to 150°C, so this item cannot be used in this temperature range.

■ Outline Dimensions

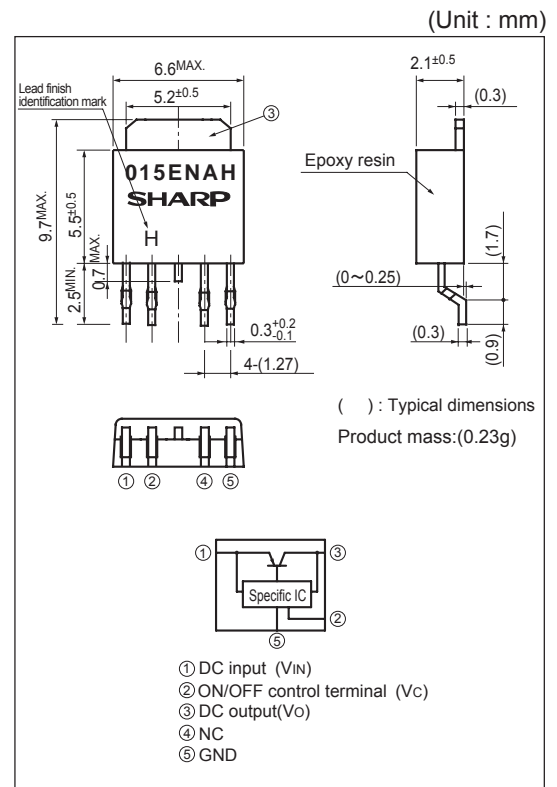

Lead finish: Lead-free solder plating
(Composition: Sn2Cu)

Notice The content of data sheet is subject to change without prior notice.

In the absence of confirmation by device specification sheets, SHARP takes no responsibility for any defects that may occur in equipment using any SHARP devices shown in catalogs, data books, etc. Contact SHARP in order to obtain the latest device specification sheets before using any SHARP device.

Electrical Characteristics

Unless otherwise specified, condition shall be $V_{IN}=V_o(TYP.)+1V, I_o=0.5A, V_c=2.7V, T_a=25^{\circ}C$

Parameter	Symbol	Conditions	MIN.	TYP.	MAX.	Unit
Input voltage	V_{IN}	-	Refer to the following table.1			V
Output voltage	V_o	-	Refer to the following table.2			V
Load regulation	Reg_L	$I_o=5mA$ to $1.5A, V_{IN}=V_o+1.5V$	-	0.5	2.0	%
Line regulation	Reg_l	$V_{IN}=V_o(TYP.)+1V$ to $V_o(TYP.)+6V, I_o=5mA$	-	0.2	1.0	%
Temperature coefficient of output voltage	TcV_o	$T_j=0$ to $+125^{\circ}C, I_o=5mA$	-	± 0.01	-	%/ $^{\circ}C$
Ripple rejection	RR	Refer to Fig.3	-	60	-	dB
*4 Dropout voltage	V_{I-O}	$I_o=1.2A$ *5	-	-	0.9	V
*6 ON-state voltage for control	$V_{C(ON)}$	-	2.0	-	-	V
ON-state current for control	$I_{C(ON)}$	-	-	-	200	μA
OFF-state voltage for control	$V_{C(OFF)}$	-	-	-	0.6	V
OFF-state current for control	$I_{C(OFF)}$	$V_c=0.4V$	-	-	5	μA
Quiescent current	I_q	$I_o=0A$	-	1	2	mA
Output OFF-state dissipation current	I_{qs}	$I_o=0A, V_c=0.4V$	-	-	5	μA

*4 Applied to PQ033ENAHZPH

*5 Input voltage shall be the value when output voltage is 95% in comparison with the initial value.

*6 In case of opening control terminal ②, output voltage turns off

Table.1 Input Voltage range

Unless otherwise specified, condition shall be $I_o=0.5A, V_c=2.7V, T_a=25^{\circ}C$

Model No.	Symbol	Conditions	MIN.	TYP.	MAX.	Unit
PQ015ENAHZPH	V_{IN}	-	2.35	-	10	V
PQ018ENAHZPH	V_{IN}	-	2.35	-	10	V
PQ025ENAHZPH	V_{IN}	-	3.0	-	10	V
PQ033ENAHZPH	V_{IN}	-	3.8	-	10	V

Table.2 Output Voltage

Unless otherwise specified, condition shall be $V_{IN}=V_o(TYP.)+1V, I_o=0.5A, V_c=2.7V, T_a=25^{\circ}C$

Model No.	Symbol	Conditions	MIN.	TYP.	MAX.	Unit
PQ015ENAHZPH	V_o	-	1.47	1.5	1.53	V
PQ018ENAHZPH	V_o	-	1.764	1.8	1.836	V
PQ025ENAHZPH	V_o	-	2.45	2.5	2.55	V
PQ033ENAHZPH	V_o	-	3.234	3.3	3.366	V

Fig.1 Typical Application

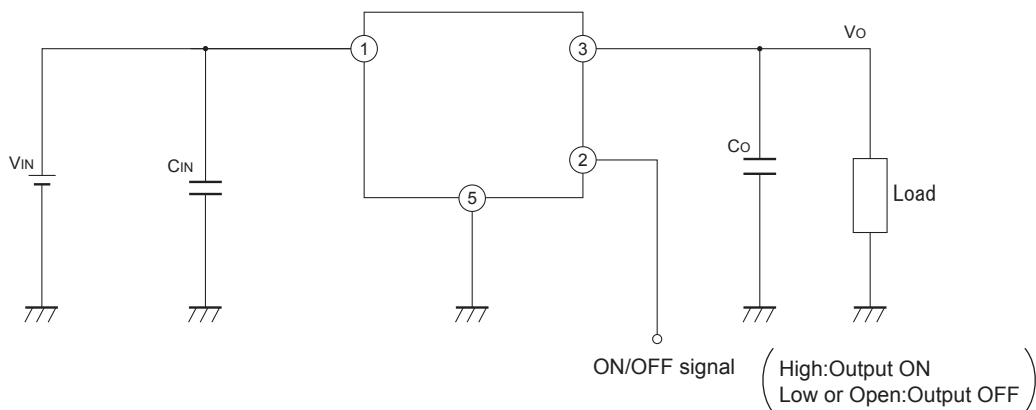

Fig.2 Test Circuit

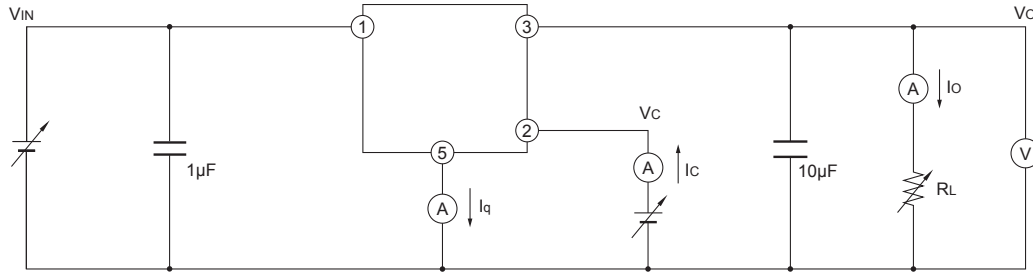
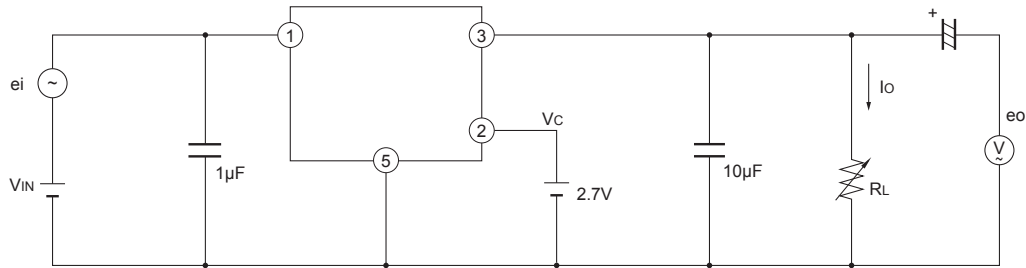
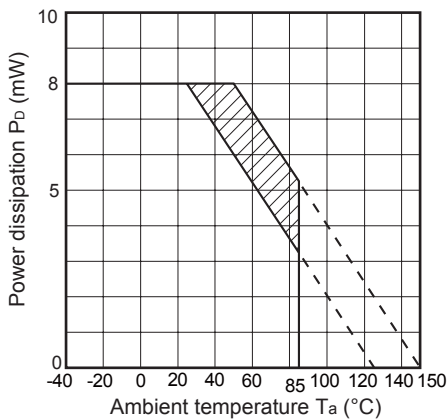

Fig.3 Test Circuit for Ripple Rejection



f=120Hz(sine wave)
 $e_i(\text{rms})=0.5\text{V}$
 $V_{IN}=V_o(\text{TYP})+2\text{V}$
 $I_o=0.3\text{A}$
 $RR=20\log(e_i(\text{rms})/e_o(\text{rms}))$

Fig.4 Power Dissipation vs. Ambient Temperature



Note) Oblique line portion: Overheat protection may operate in this area.

Fig.5 Overcurrent Protection Characteristics (PQ018ENAHZPH)

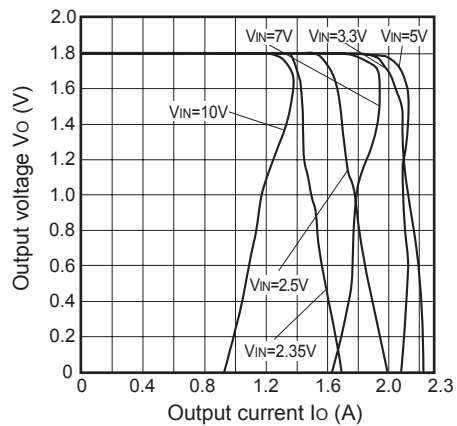

Fig.6 Output Voltage vs. Ambient Temperature (PQ018ENAHZPH)

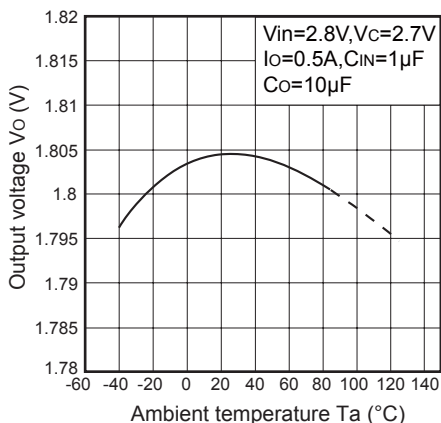

Fig.7 Dropout Voltage vs. Ambient Temperature (PQ033ENAHZPH)

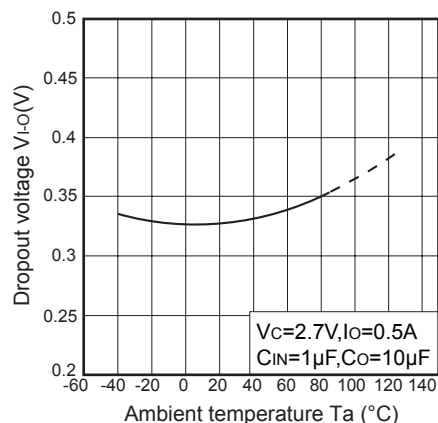

Fig.8 Line Regulation vs. Ambient Temperature

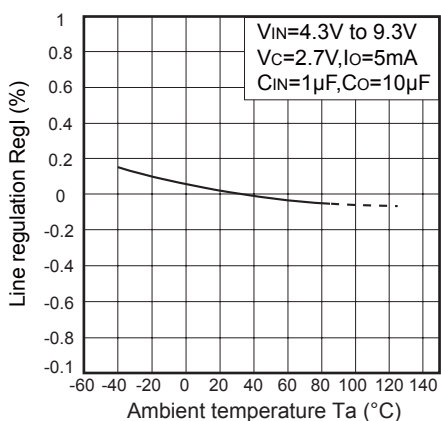

Fig.9 Load Regulation vs. Ambient Temperature (PQ018ENAHZPH)

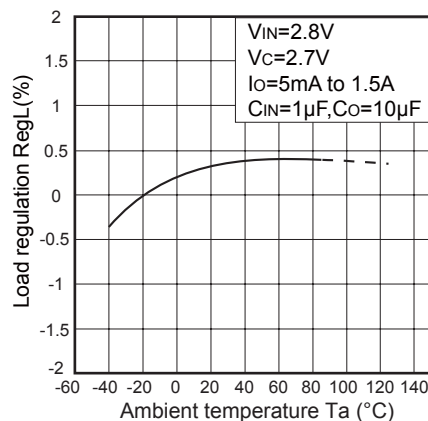

Fig.10 Quiescent Current vs. Ambient Temperature (PQ018ENAHZPH)

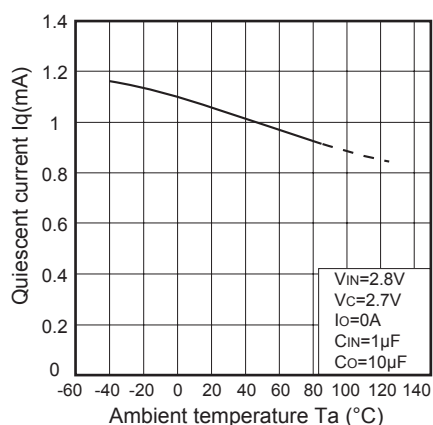

Fig.11 Output Voltage vs. ON/OFF Control Voltage (PQ018ENAHZPH)

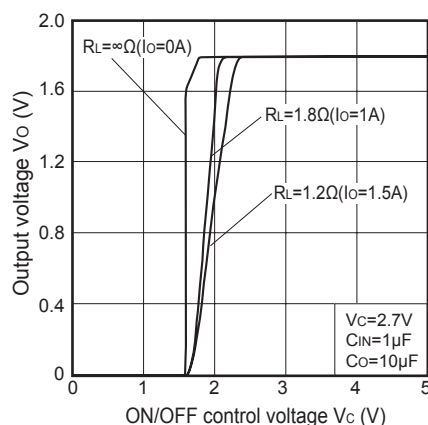

Fig.12 Circuit Operating Current vs. Input Voltage (PQ018ENAHZPH)

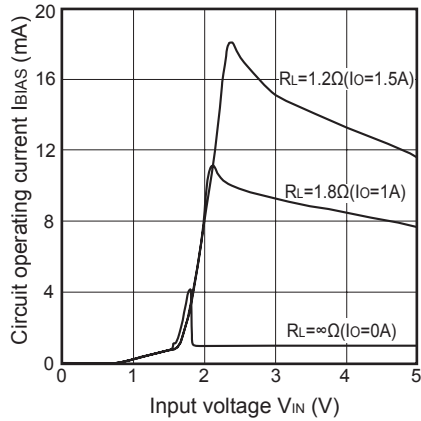

Fig.13 Dropout Voltage vs. Output Current (PQ033ENAHZPH)

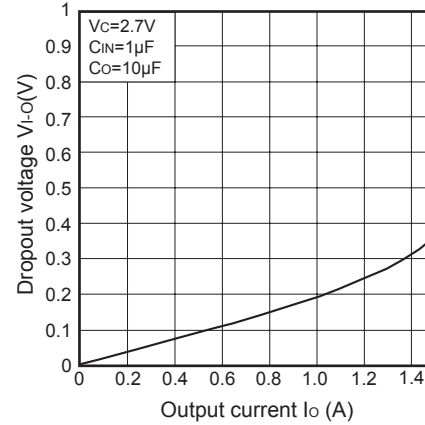

Fig.14 Ripple Rejection vs. Input Ripple Frequency (PQxxxENAHZPH)

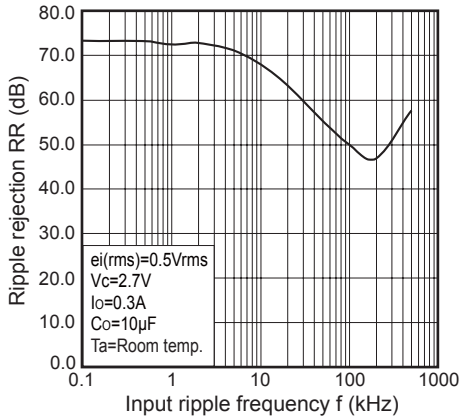

Fig.15 Ripple Rejection vs. Output Current (PQ018ENAHZPH)

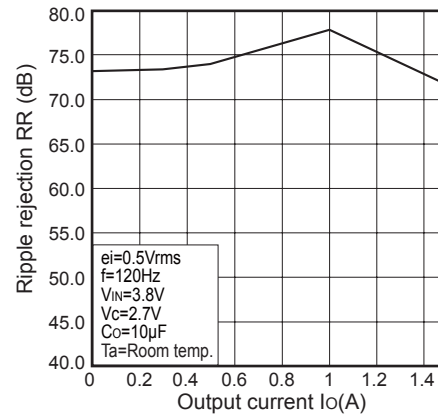
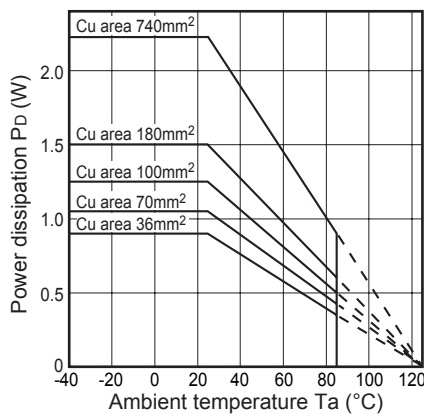
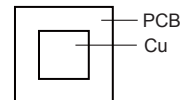

Fig.16 Power Dissipation vs. Ambient Temperature (Typical Value)



Mounting PCB



Material : Glass-cloth epoxy resin
 Size : 50×50×1.6mm
 Cu thickness : 35μm