

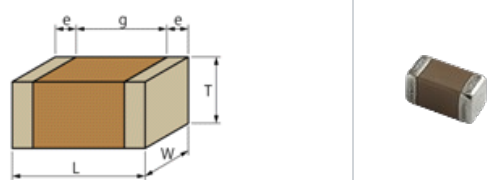

< List of part numbers with package codes >

GCM2195C1H562JA16D , GCM2195C1H562JA16J

Shape



L size	2.0 ±0.15mm
W size	1.25 ±0.15mm
T size	0.85 ±0.1mm
External terminal width e	0.2 to 0.7mm
Distance between external terminals g	0.7mm min.
Size code in inch(mm)	0805 (2012M)

Notes

Please use replacements or Recommended.

References

Packaging	Specifications	Minimum quantity
D	φ180mm Paper taping	4000
J	φ330mm Paper taping	10000

Mass (typ.)	
1 piece	9.5mg
φ180mm Reel	152g

Specifications

Capacitance	5600pF ±5%
Rated voltage	50Vdc
Temperature characteristics (complied standard)	C0G(EIA)
Temperature coefficient	0±30ppm/°C
Temperature range of temperature characteristics	25 to 125°C
Operating temperature range	-55 to 125°C

⚠ Attention

- 1.This datasheet is downloaded from the website of Murata Manufacturing Co., Ltd. Therefore, it's specifications are subject to change or our products in it may be discontinued without advance notice. Please check with our sales representatives or product engineers before ordering.
- 2.This datasheet has only typical specifications because there is no space for detailed specifications. Therefore, please review our product specifications or consult the approval sheet for product specifications before ordering.

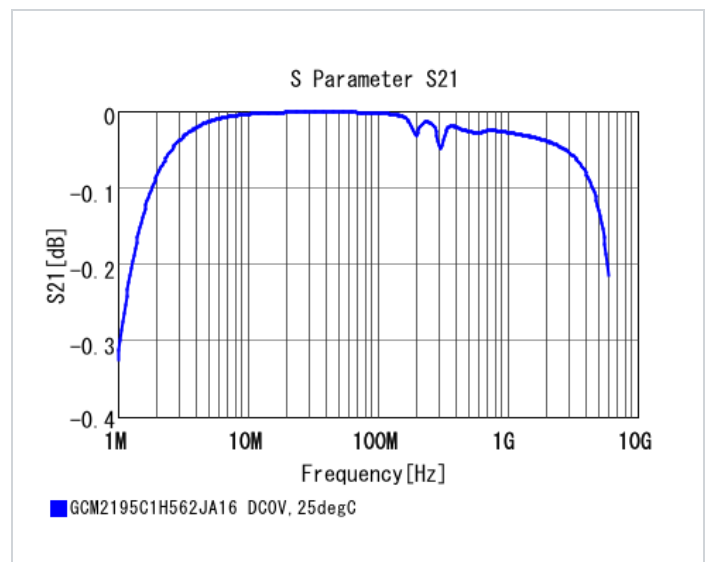
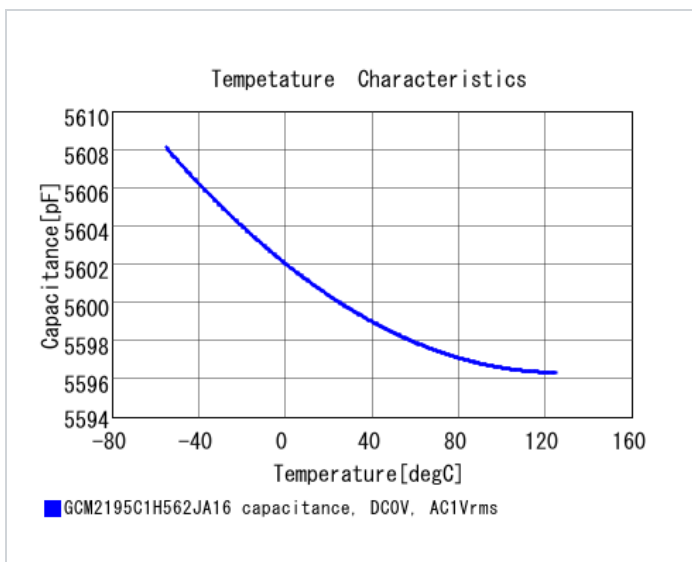
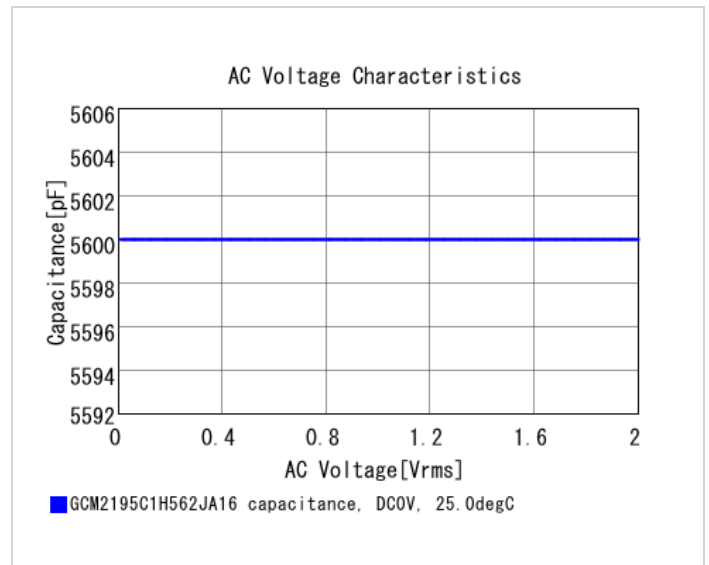
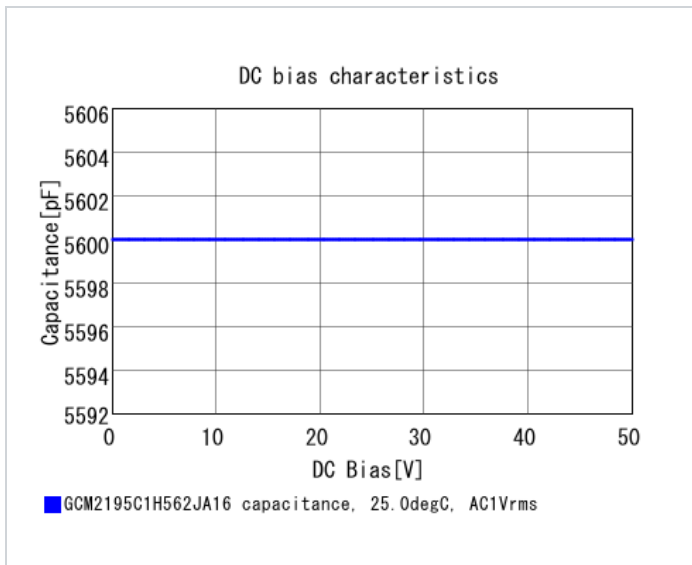
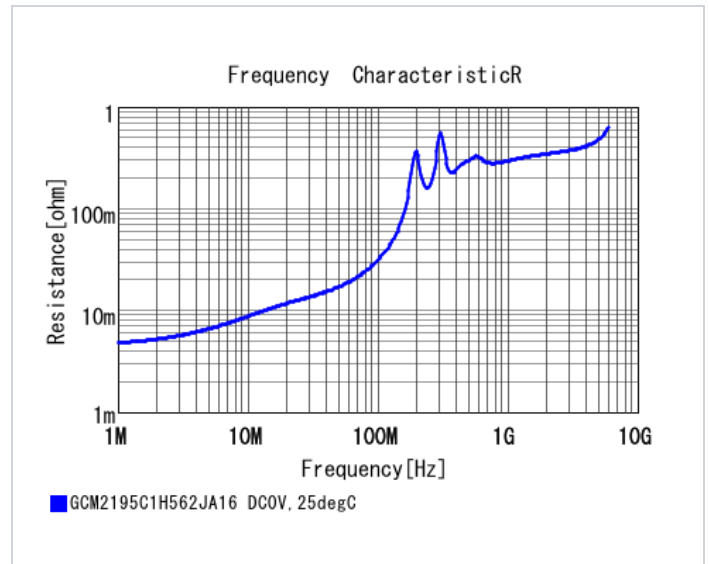
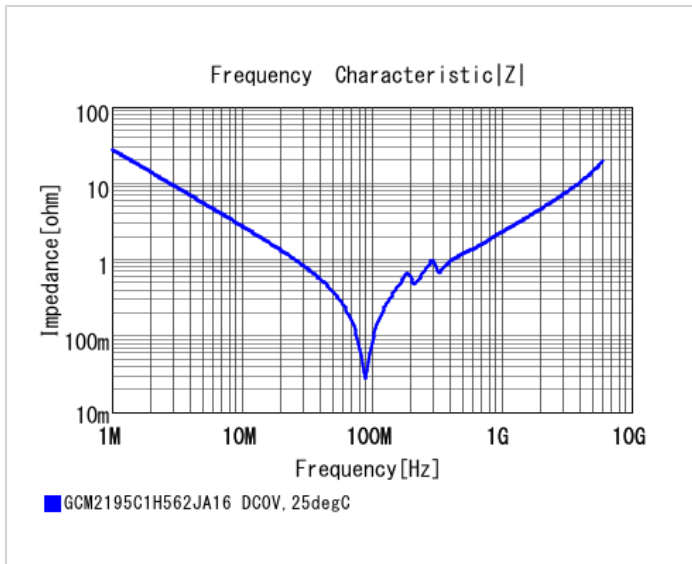

⚠ Attention

1.This datasheet is downloaded from the website of Murata Manufacturing Co., Ltd. Therefore, it's specifications are subject to change or our products in it may be discontinued without advance notice. Please check with our sales representatives or product engineers before ordering.

2.This datasheet has only typical specifications because there is no space for detailed specifications. Therefore, please review our product specifications or consult the approval sheet for product specifications before ordering.