

MOSFET - P-Channel, PowerTrench[®], Logic Level -40 V, -25 A, 21 mΩ



ON Semiconductor[®]

www.onsemi.com

FDD9511L-F085

Features

- Typ $r_{DS(on)}$ = 17 mΩ at $V_{GS} = -10$ V; $I_D = -25$ A
- Typ $Q_{g(tot)}$ = 17 nC at $V_{GS} = -10$ V; $I_D = -25$ A
- UIS Capability
- Qualified to AEC Q101
- These Devices are Pb-Free and are RoHS Compliant

Applications

- Automotive Engine Control
- Powertrain Management
- Solenoid and Motor Drivers
- Electrical Power Steering
- Integrated Starter/Alternator
- Distributed Power Architectures and VRM
- Primary Switch for 12 V Systems

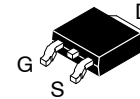

DPAK
TO-252
CASE 369AS

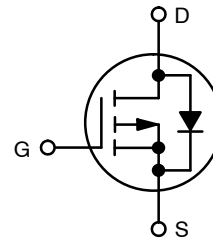

ABSOLUTE MAXIMUM RATINGS ($T_J = 25^\circ\text{C}$ unless otherwise noted)

Rating	Symbol	Value	Unit
Drain to Source Voltage	V_{DSS}	-40	V
Gate to Source Voltage	V_{GS}	± 16	V
Drain Current - Continuous ($V_{GS} = -10$ V) ($T_C = 25^\circ\text{C}$) (Note 1)	I_D	-25	A
Pulsed Drain Current ($T_C = 25^\circ\text{C}$)	I_D	See Figure 4	A
Single Pulse Avalanche Energy (Note 2)	E_{AS}	25	mJ
Power Dissipation	P_D	48.4	W
Derate above 25°C	P_D	0.32	W/ $^\circ\text{C}$
Operating and Storage Temperature Range	T_J, T_{STG}	-55 to +175	$^\circ\text{C}$
Thermal Resistance (Junction to Case)	$R_{\theta JC}$	3.1	$^\circ\text{C}/\text{W}$
Maximum Thermal Resistance (Junction to Ambient) (Note 3)	$R_{\theta JA}$	52	$^\circ\text{C}/\text{W}$

Stresses exceeding those listed in the Maximum Ratings table may damage the device. If any of these limits are exceeded, device functionality should not be assumed, damage may occur and reliability may be affected.

1. Current is limited by wirebond configuration
2. Starting $T_J = 25^\circ\text{C}$, $L = 0.08$ mH, $I_{AS} = -25$ A, $V_{DD} = -40$ V during inductor charging and $V_{DD} = 0$ V during time in avalanche
3. $R_{\theta JA}$ is the sum of the junction-to-case and case-to-ambient thermal resistance where the case thermal reference is defined as the solder mounting surface of the drain pins. $R_{\theta JC}$ is guaranteed by design while $R_{\theta JA}$ is determined by the user's board design. The maximum rating presented here is based on mounting on a 1 in² pad of 2 oz copper.

ORDERING INFORMATION

See detailed ordering and shipping information on page 2 of this data sheet.

FDD9511L-F085

PACKAGE MARKING AND ORDERING INFORMATION

Device	Device Marking	Package	Reel Size	Tape Width	Quantity
FDD9511L-F085	FDD9511L	D-PAK (TO-252)	13"	12 mm	2500 Units

ELECTRICAL CHARACTERISTICS (T_J = 25°C unless otherwise noted)

Symbol	Parameter	Test Conditions	Min	Typ	Max	Unit
--------	-----------	-----------------	-----	-----	-----	------

OFF CHARACTERISTICS

BV _{DSS}	Drain to Source Breakdown Voltage	V _{GS} = 0 V, I _D = -250 μA	-40	-	-	V	
I _{DSS}	Drain to Source Leakage Current	V _{DS} = -40 V, V _{GS} = 0 V	T _J = 25°C	-	-	-1	μA
			T _J = 175°C (Note 4)	-	-	-1	mA
I _{GSS}	Gate to Source Leakage Current	V _{GS} = ±16 V	-	-	±100	nA	

ON CHARACTERISTICS

V _{GS(th)}	Gate to Source Threshold Voltage	V _{GS} = V _{DS} , I _D = 250 μA	-1	-1.8	-3	V	
R _{DS(on)}	Drain to Source On-Resistance	V _{GS} = -4.5 V, I _D = -12.5 A, T _J = 25°C	-	24	32	mΩ	
		V _{GS} = -10 V, I _D = -25 A	T _J = 25°C	-	17	21	mΩ
			T _J = 175°C (Note 4)	-	28	36	mΩ

DYNAMIC CHARACTERISTICS

C _{iss}	Input Capacitance	V _{DS} = -20 V, V _{GS} = 0 V, f = 100 KHz	-	1200	-	pF		
C _{oss}	Output Capacitance		-	480	-	pF		
C _{rss}	Reverse Transfer Capacitance		-	27	-	pF		
R _g	Gate Resistance	V _{GS} = -0.5 V, f = 1 MHz	-	38	-	Ω		
Q _{g(tot)}	Total Gate Charge	V _{DD} = -20 V, I _D = -25 A	V _{GS} = 0 V to -10 V	-	17	23	nC	
Q _{g(-4.5)}	Total Gate Charge			V _{GS} = 0 V to -4.5 V	-	8	-	nC
Q _{g(th)}	Threshold Gate Charge			V _{GS} = 0 V to -1 V	-	1	-	nC
Q _{gs}	Gate to Source Gate Charge	V _{DD} = -20 V, I _D = -25 A	-	4	-	nC		
Q _{gd}	Gate to Drain "Miller" Charge		-	2.5	-	nC		

SWITCHING CHARACTERISTICS

t _{on}	Turn-On Time	V _{DD} = -20 V, I _D = -25 A, V _{GS} = -10 V, R _{GEN} = 6 Ω	-	-	45	ns
t _{d(on)}	Turn-On Delay Time		-	7	-	ns
t _r	Turn-On Rise Time		-	24	-	ns
t _{d(off)}	Turn-Off Delay Time		-	120	-	ns
t _f	Turn-Off Fall Time		-	40	-	ns
t _{off}	Turn-Off Time		-	-	235	ns

DRAIN-SOURCE DIODE CHARACTERISTICS

V _{SD}	Source to Drain Diode Voltage	V _{GS} = 0 V, I _{SD} = -25 A	-	-0.95	-1.25	V
		V _{GS} = 0 V, I _{SD} = -12.5 A	-	-0.9	-1.2	V
T _{rr}	Reverse Recovery Time	I _F = -25 A, dI _{SD} /dt = 100 A/μs	-	36	54	ns
Q _{rr}	Reverse Recovery Charge		-	22	33	nC

Product parametric performance is indicated in the Electrical Characteristics for the listed test conditions, unless otherwise noted. Product performance may not be indicated by the Electrical Characteristics if operated under different conditions.

4. The maximum value is specified by design at T_J = 175°C. Product is not tested to this condition in production

TYPICAL CHARACTERISTICS

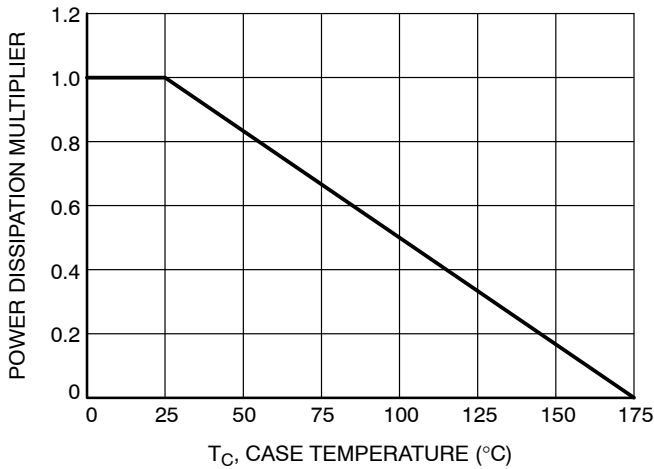

Figure 1. Normalized Power Dissipation vs. Case Temperature

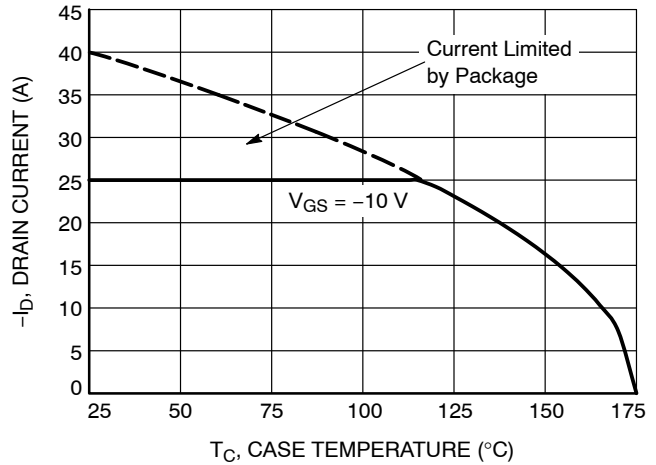

Figure 2. Maximum Continuous Drain Current vs. Case Temperature

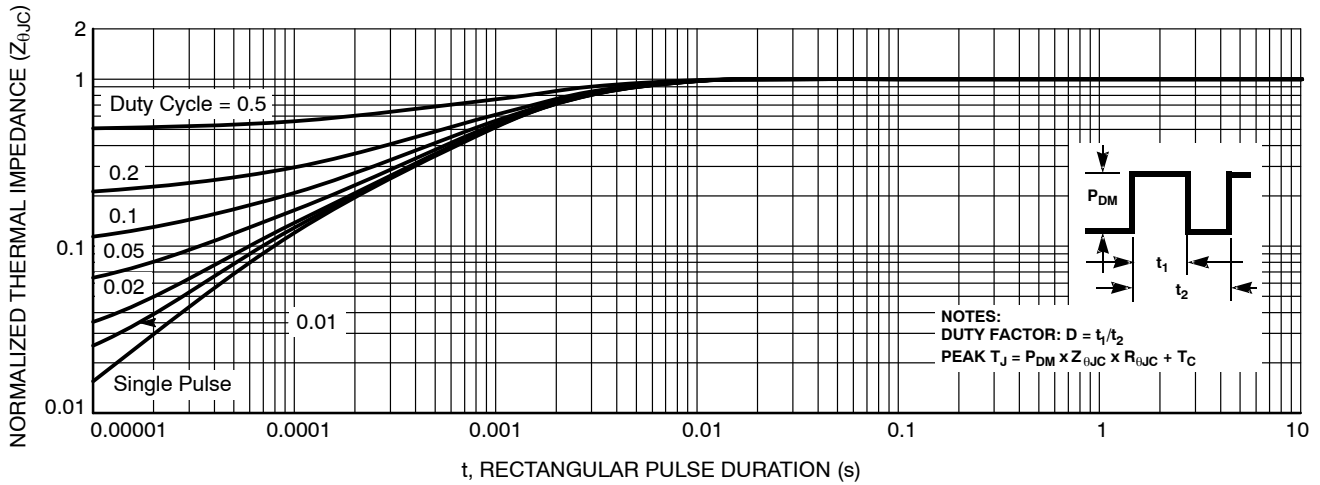

Figure 3. Normalized Maximum Transient Thermal Impedance

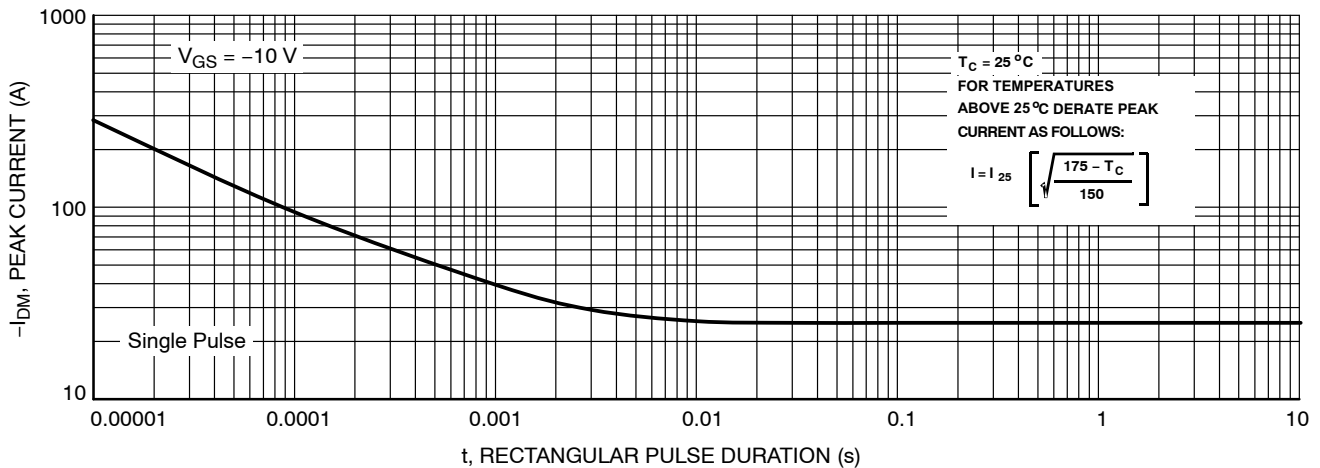

Figure 4. Peak Current Capability

TYPICAL CHARACTERISTICS

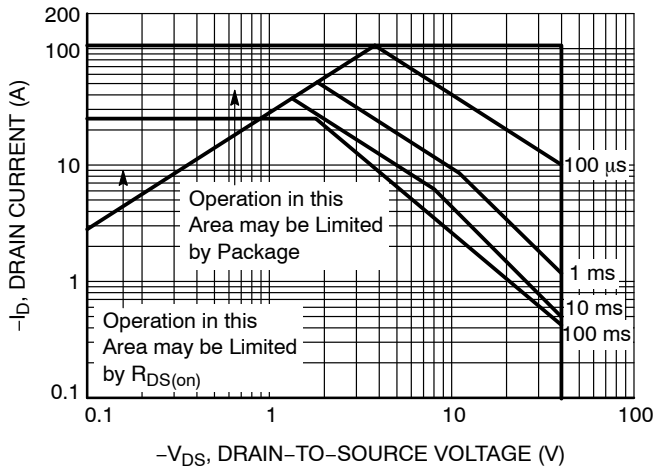

Figure 5. Forward Bias Safe Operating Area

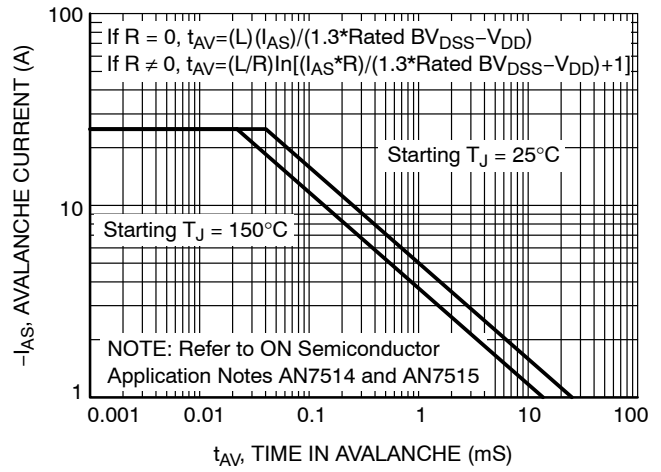

Figure 6. Unclamped Inductive Switching Capability

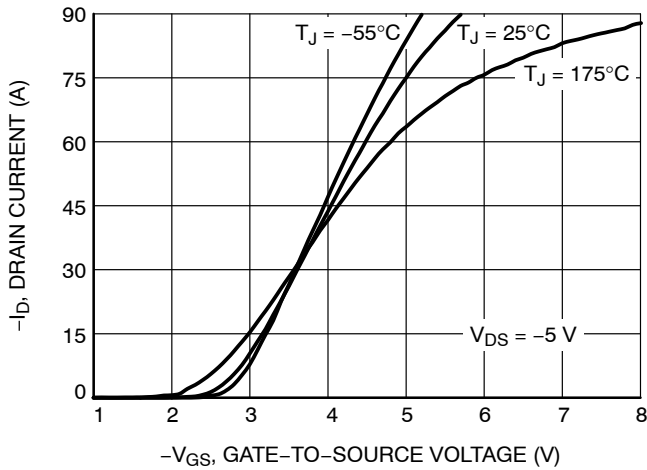

Figure 7. Transfer Characteristics

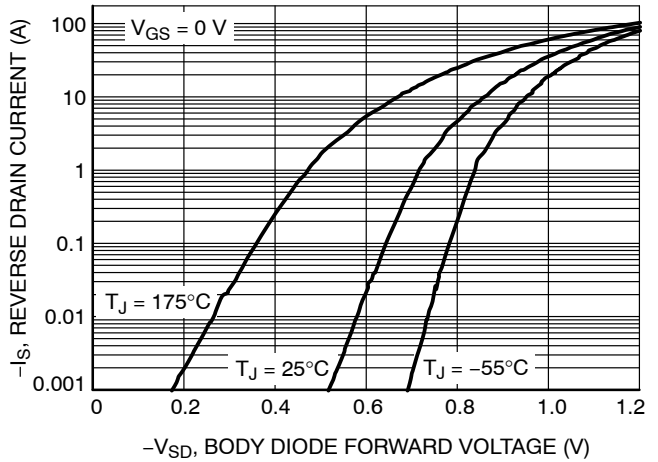

Figure 8. Forward Diode Characteristics

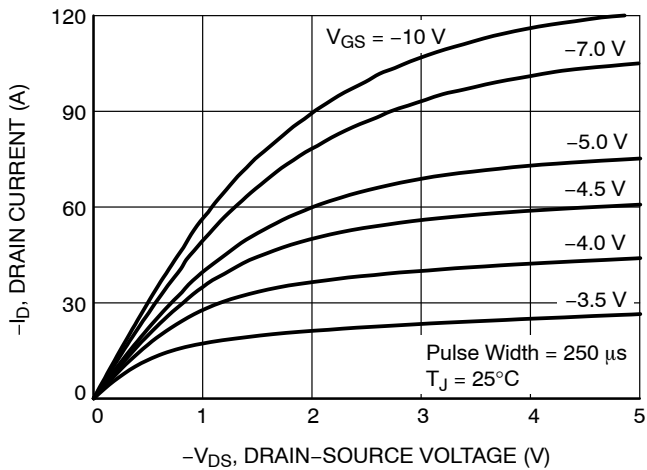

Figure 9. Saturation Characteristics

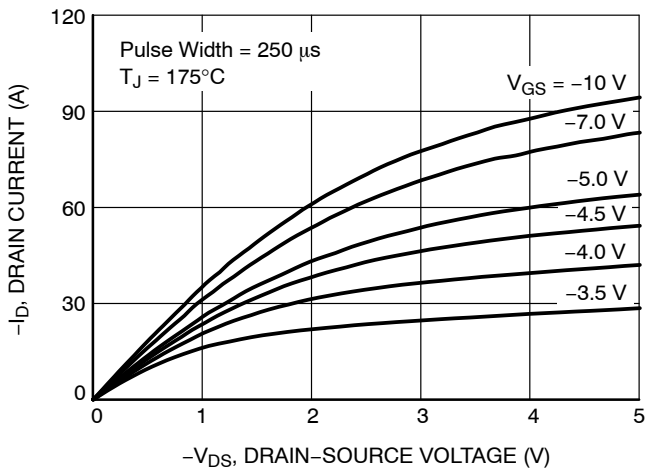

Figure 10. Saturation Characteristics

TYPICAL CHARACTERISTICS

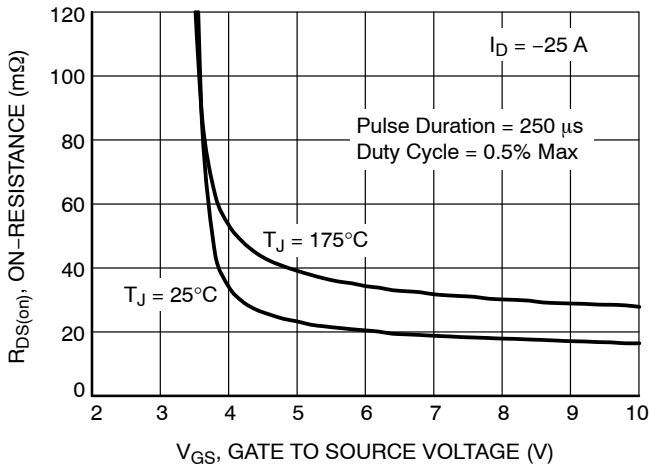

Figure 11. $R_{DS(on)}$ vs. Gate Voltage

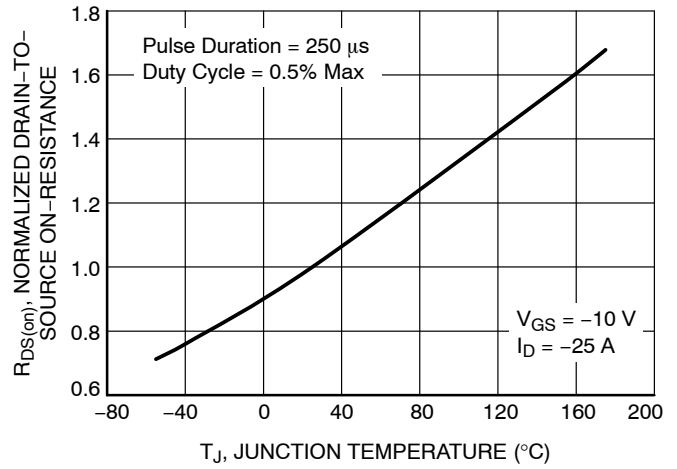

Figure 12. Normalized $R_{DS(on)}$ vs. Junction Temperature

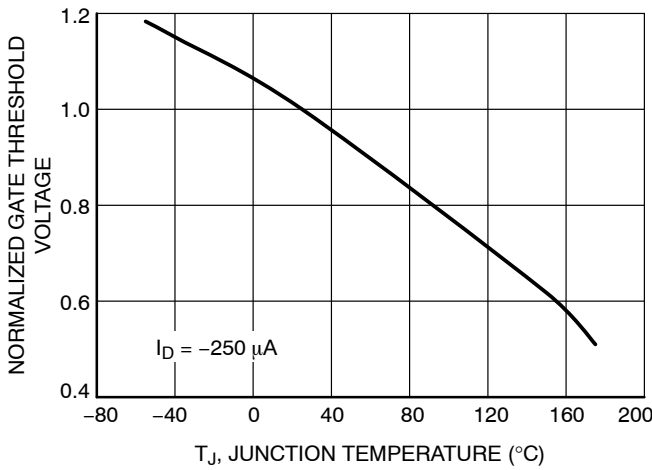

Figure 13. Normalized Gate Threshold Voltage vs. Temperature

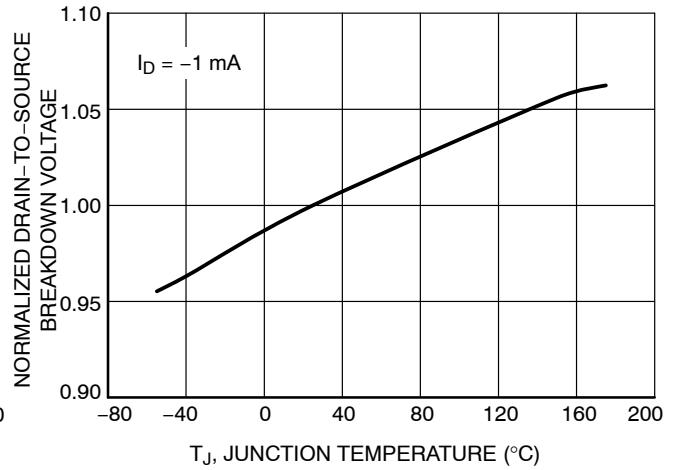

Figure 14. Normalized Drain to Source Breakdown Voltage vs. Junction Temperature

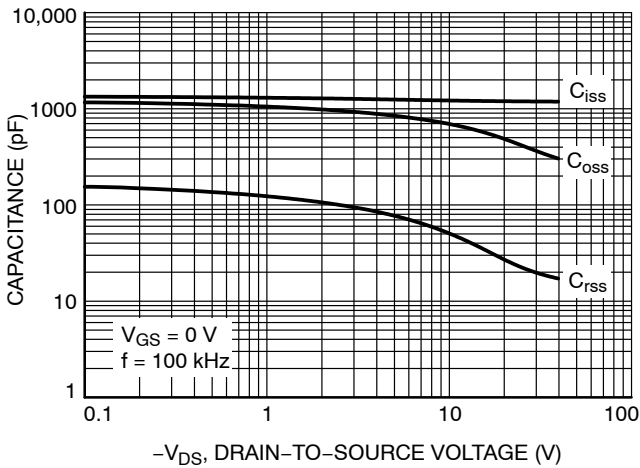

Figure 15. Capacitance vs. Drain-to-Source Voltage

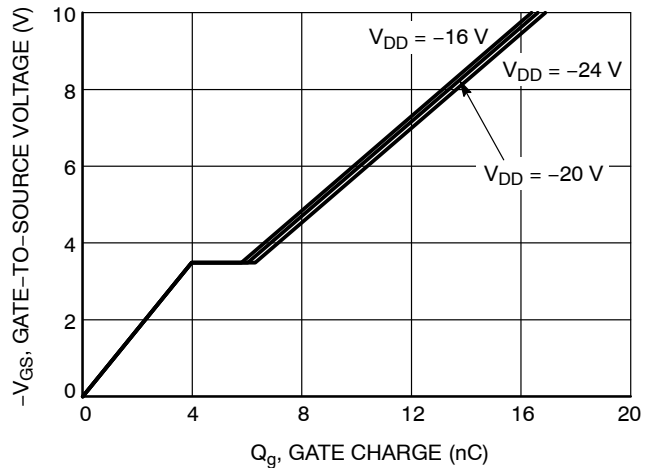
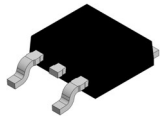

Figure 16. Gate Charge vs. Gate-to-Source Voltage

MECHANICAL CASE OUTLINE PACKAGE DIMENSIONS



DPAK3 (TO-252 3 LD) CASE 369AS ISSUE A

DATE 28 SEP 2022

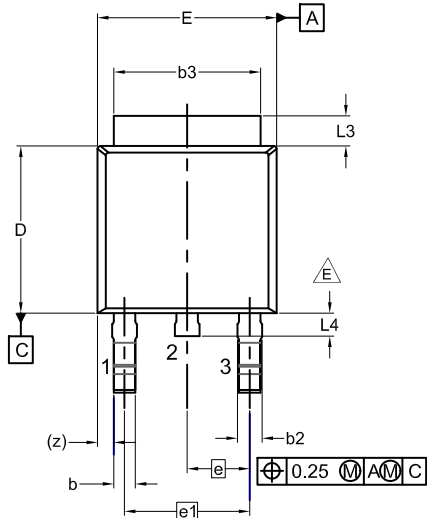

- NOTES: UNLESS OTHERWISE SPECIFIED
 A) THIS PACKAGE CONFORMS TO JEDEC, TO-252, ISSUE C, VARIATION AA.
 B) ALL DIMENSIONS ARE IN MILLIMETERS.
 C) DIMENSIONING AND TOLERANCING PER ASME Y14.5M-2009.
 D) SUPPLIER DEPENDENT MOLD LOCKING HOLES OR CHAMFERED CORNERS OR EDGE PROTRUSION.
 E) FOR DIODE PRODUCTS, L4 IS 0.25 MM MAX.
 F) DIMENSIONS ARE EXCLUSIVE OF BURRS, MOLD FLASH AND TIE BAR EXTRUSIONS.
 G) LAND PATTERN RECOMMENDATION IS BASED ON IPC7351A STD TO228P991X239-3N.

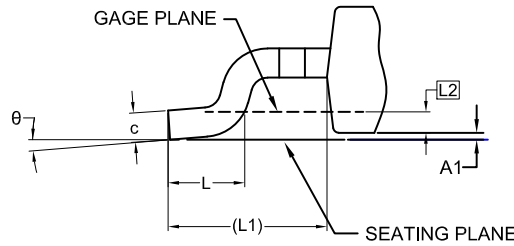

DETAIL A
(ROTATED -90°)
SCALE: 12X

DIM	MILLIMETERS		
	MIN.	NOM.	MAX.
A	2.18	2.29	2.39
A1	0.00	-	0.127
b	0.64	0.77	0.89
b2	0.76	0.95	1.14
b3	5.21	5.34	5.46
c	0.45	0.53	0.61
c2	0.45	0.52	0.58
D	5.97	6.10	6.22
D1	5.21	-	-
E	6.35	6.54	6.73
E1	4.32	-	-
e	2.286 BSC		
e1	4.572 BSC		
H	9.40	9.91	10.41
L	1.40	1.59	1.78
L1	2.90 REF		
L2	0.51 BSC		
L3	0.89	1.08	1.27
L4	-	-	1.02
θ	0°	--	10°

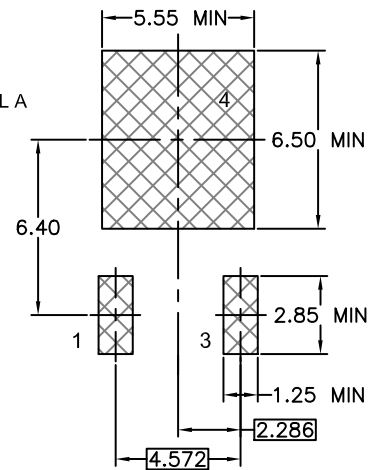
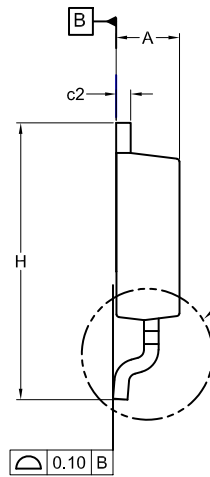
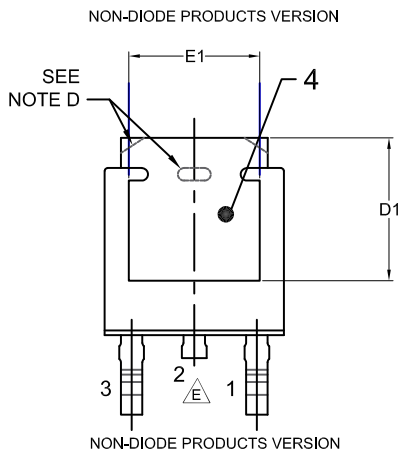

LAND PATTERN RECOMMENDATION

GENERIC MARKING DIAGRAM*



- XXXX = Specific Device Code
- A = Assembly Location
- Y = Year
- WW = Work Week
- ZZ = Assembly Lot Code

*This information is generic. Please refer to device data sheet for actual part marking. Pb-free indicator, "G" or microdot "•", may or may not be present. Some products may not follow the Generic Marking.

*FOR ADDITIONAL INFORMATION ON OUR PB-FREE STRATEGY AND SOLDERING DETAILS, PLEASE DOWNLOAD THE ON SEMICONDUCTOR SOLDERING AND MOUNTING TECHNIQUES REFERENCE MANUAL, SOLDERRM/D.

DOCUMENT NUMBER:	98AON13810G	Electronic versions are uncontrolled except when accessed directly from the Document Repository. Printed versions are uncontrolled except when stamped "CONTROLLED COPY" in red.
DESCRIPTION:	DPAK3 (TO-252 3 LD)	PAGE 1 OF 1

onsemi and ONSEMI are trademarks of Semiconductor Components Industries, LLC dba onsemi or its subsidiaries in the United States and/or other countries. onsemi reserves the right to make changes without further notice to any products herein. onsemi makes no warranty, representation or guarantee regarding the suitability of its products for any particular purpose, nor does onsemi assume any liability arising out of the application or use of any product or circuit, and specifically disclaims any and all liability, including without limitation special, consequential or incidental damages. onsemi does not convey any license under its patent rights nor the rights of others.

onsemi, **Onsemi**, and other names, marks, and brands are registered and/or common law trademarks of Semiconductor Components Industries, LLC dba "**onsemi**" or its affiliates and/or subsidiaries in the United States and/or other countries. **onsemi** owns the rights to a number of patents, trademarks, copyrights, trade secrets, and other intellectual property. A listing of **onsemi**'s product/patent coverage may be accessed at www.onsemi.com/site/pdf/Patent-Marking.pdf. **onsemi** reserves the right to make changes at any time to any products or information herein, without notice. The information herein is provided "as-is" and **onsemi** makes no warranty, representation or guarantee regarding the accuracy of the information, product features, availability, functionality, or suitability of its products for any particular purpose, nor does **onsemi** assume any liability arising out of the application or use of any product or circuit, and specifically disclaims any and all liability, including without limitation special, consequential or incidental damages. Buyer is responsible for its products and applications using **onsemi** products, including compliance with all laws, regulations and safety requirements or standards, regardless of any support or applications information provided by **onsemi**. "Typical" parameters which may be provided in **onsemi** data sheets and/or specifications can and do vary in different applications and actual performance may vary over time. All operating parameters, including "Typicals" must be validated for each customer application by customer's technical experts. **onsemi** does not convey any license under any of its intellectual property rights nor the rights of others. **onsemi** products are not designed, intended, or authorized for use as a critical component in life support systems or any FDA Class 3 medical devices or medical devices with a same or similar classification in a foreign jurisdiction or any devices intended for implantation in the human body. Should Buyer purchase or use **onsemi** products for any such unintended or unauthorized application, Buyer shall indemnify and hold **onsemi** and its officers, employees, subsidiaries, affiliates, and distributors harmless against all claims, costs, damages, and expenses, and reasonable attorney fees arising out of, directly or indirectly, any claim of personal injury or death associated with such unintended or unauthorized use, even if such claim alleges that **onsemi** was negligent regarding the design or manufacture of the part. **onsemi** is an Equal Opportunity/Affirmative Action Employer. This literature is subject to all applicable copyright laws and is not for resale in any manner.

ADDITIONAL INFORMATION

TECHNICAL PUBLICATIONS:

Technical Library: www.onsemi.com/design/resources/technical-documentation
onsemi Website: www.onsemi.com

ONLINE SUPPORT: www.onsemi.com/support

For additional information, please contact your local Sales Representative at www.onsemi.com/support/sales