

4-Channel Charge Pump LED Driver with Current Balancing and Wide Range PWM Dimming AP3605**General Description**

The AP3605 is a step-up DC/DC converter based on 1.5x charge pump current source, it is specially designed for LED supplies in backlight display.

The AP3605 can provide constant current up to 20mA for each LED, which is programmed by an external resistor, so it has a total capability to provide 80mA for 4 LEDs. The chip has a good performance of LED current matching and allows PWM brightness dimming control. Additionally, high switching frequency up to 1MHz enables the use of two small external flying capacitors. Internal soft-start circuitry prevents excessive inrush current during start-up.

The AP3605 supply voltage range is from 2.7V to 5.5V, ideally suited for applications powered by the Li-ion battery.

The AP3605 is available in a 3mmx3mm QFN-3x3-16 tiny package. Its operating temperature range is -40°C to 85°C.

Features

- Regulated Output Current with $\pm 3\%$ Matching
- Regulated $\pm 10\%$ Output Current Source
- Drive up to 4 LEDs at 20mA Each
- Wide Operating Voltage Range: 2.7V to 5.5V
- High Efficiency up to 93%
- High Operating Frequency: 1MHz
- Built-in Soft-Start to Limit the Inrush Current
- LED Brightness Control through PWM and Analog Signal
- PWM Dimming Frequency up to 50kHz
- Built-in Standby Mode to Get PWM Dimming Duty Cycle Control Linearity
- Built-in OTSD (Over Temperature Shutdown) Function to Protect the Device from Burn Out

Applications

- Mobile Phone
- MP3, MP4
- White LED Backlight in Mobile Phone, PDA

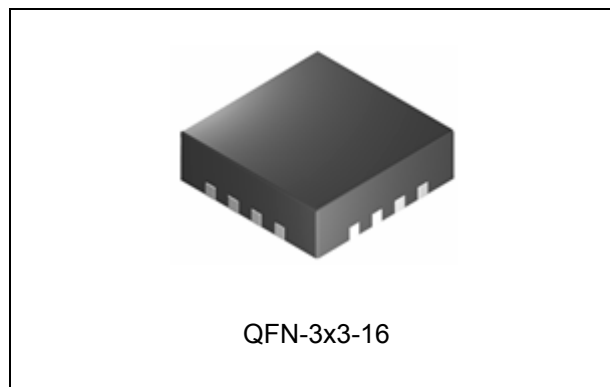
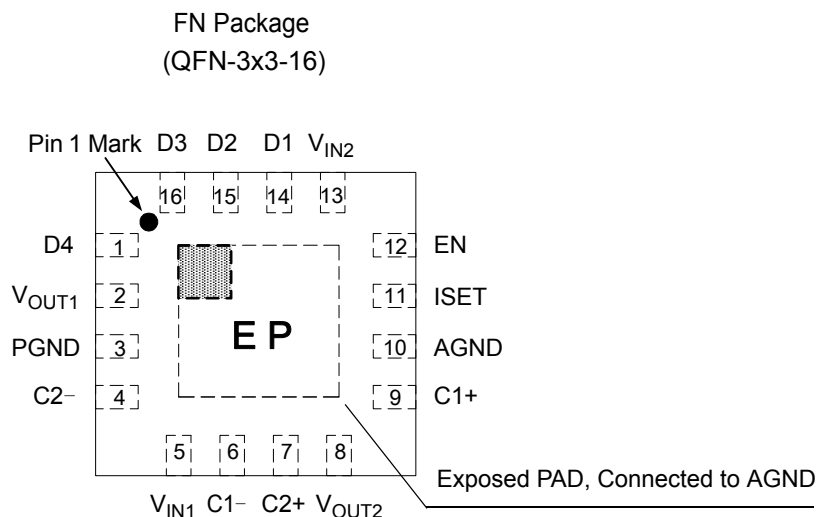

Figure 1. Package Type of AP3605

4-Channel Charge Pump LED Driver with Current Balancing and Wide Range PWM Dimming AP3605

Pin Configuration



Note: Pin 2 should be connected with Pin 8 and Pin 5 should be connected with Pin 13 on PCB board.

Figure 2. Pin Configuration of AP3605 (Top View)

Pin Description

Pin Number	Pin Name	Function
1, 16, 15, 14	D4 to D1	Current Source Output. Connect the anode of the white LEDs to these outputs
2, 8	V _{OUT1} , V _{OUT2}	Output Pin 1 and 2, must be connected together. The output capacitor should be placed closely to these pins
3	PGND	Power Ground. Connect this pin with power ground plane
4	C2-	Flying Capacitor 2 Negative Terminal. The flying capacitor 2 should be connected as close to this pin as possible
5, 13	V _{IN1} , V _{IN2}	Supply Voltage Input 1 and 2, must be connected together
6	C1-	Flying Capacitor 1 Negative Terminal. The flying capacitor 1 should be connected as close to this pin as possible
7	C2+	Flying Capacitor 2 Positive Terminal. The flying capacitor 2 should be connected as close to this pin as possible
9	C1+	Flying Capacitor 1 Positive Terminal. The flying capacitor 1 should be connected as close to this pin as possible
10	AGND	Analog Ground. Connect this pin with control signal ground plane. PGND, AGND and the exposed PAD should be connected together
11	ISET	Current Source Set Pin. Connect a resistor between this pin and GND to set the maximum LED current
12	EN	Enable Control Input. Logic high enables the IC; while logic low forces the device into shut-down mode to reduce the supply current to less than 1μA. Add a PWM signal to this pin to achieve brightness control

4-Channel Charge Pump LED Driver with Current Balancing and Wide Range PWM Dimming AP3605

Functional Block Diagram

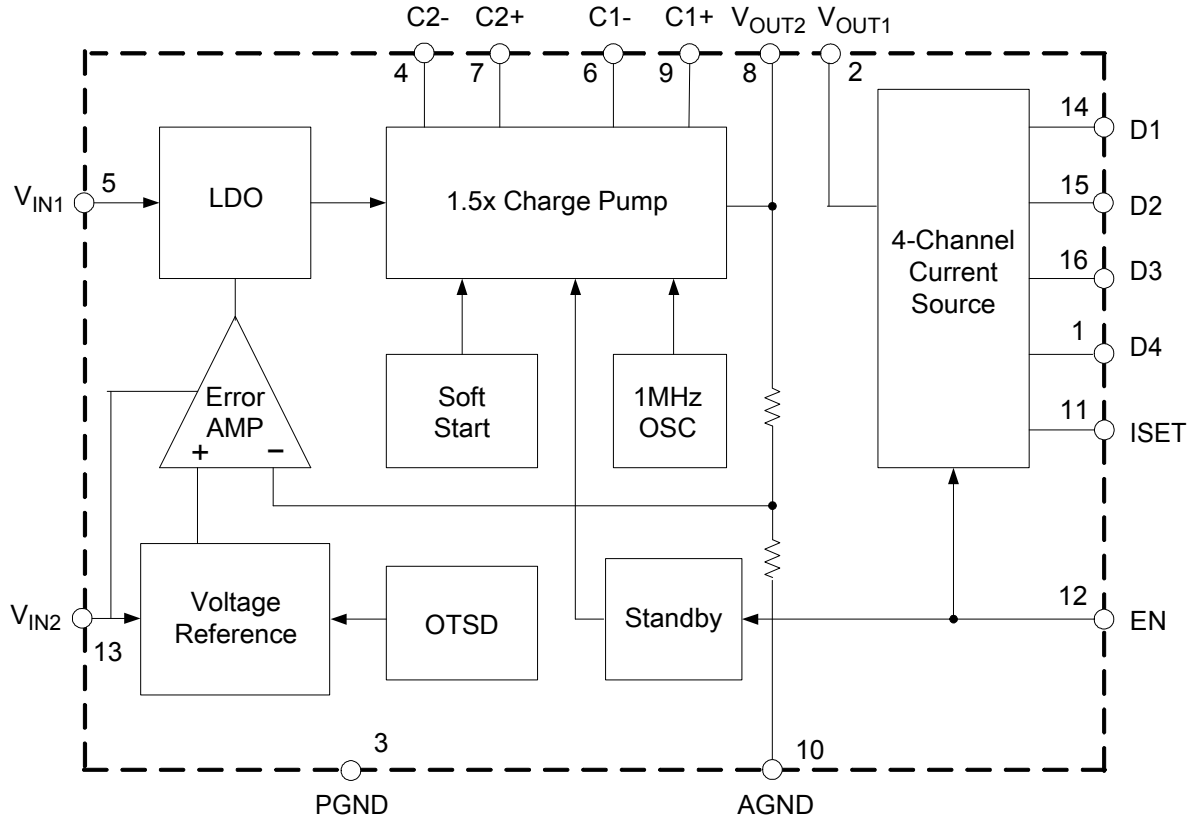
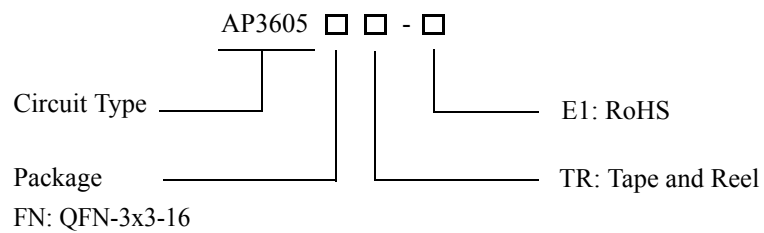

Figure 3. Functional Block Diagram of AP3605

Ordering Information



Package	Temperature Range	Part Number	Marking ID	Packing Type
QFN-3x3-16	-40 to 85°C	AP3605FNTR-E1 (Note 1)	F1A	Tape & Reel

Note 1: AP3605FNTR-E1 is a green product.

**4-Channel Charge Pump LED Driver with Current Balancing and Wide Range PWM Dimming AP3605****Absolute Maximum Ratings (Note 2)**

Parameter	Symbol	Value	Unit
Input Voltage	V_{IN}	-0.3 to 6	V
EN Pin Voltage	V_{EN}	-0.3 to 6	V
V_{OUT1} Pin Voltage	V_{OUT1}	-0.3 to 6	V
V_{OUT2} Pin Voltage	V_{OUT2}	-0.3 to 6	V
ISET Pin Voltage	V_{ISET}	-0.3 to 6	V
Output Current at V_{OUT2} Pin	I_{OUT2}	150	mA
Thermal Resistance (Junction to Ambient, no Heat sink)	$R_{\theta JA}$	60	$^{\circ}C/W$
Operating Junction Temperature	T_J	150	$^{\circ}C$
Storage Temperature Range	T_{STG}	-65 to 150	$^{\circ}C$
Lead Temperature (Soldering, 10sec)	T_{LEAD}	260	$^{\circ}C$
ESD (Human Body Model)		2000	V

Note 2: Stresses greater than those listed under "Absolute Maximum Ratings" may cause permanent damage to the device. These are stress ratings only, and functional operation of the device at these or any other conditions beyond those indicated under "Recommended Operating Conditions" is not implied. Exposure to "Absolute Maximum Ratings" for extended periods may affect device reliability.

Recommended Operating Conditions

Parameter	Symbol	Min	Max	Unit
Input Voltage	V_{IN}	2.7	5.5	V
Operating Temperature	T_A	-40	85	$^{\circ}C$
Current Source Set Resistor	R_{ISET}	1.44		$k\Omega$



4-Channel Charge Pump LED Driver with Current Balancing and Wide Range PWM Dimming AP3605

Electrical Characteristics

($V_{IN}=3.5V$, $V_{EN}=V_{IN}$, $R_{ISET}=1.8k\Omega$, $C_{FLY1}=C_{FLY2}=C_{IN}=C_{OUT}=1\mu F$, $T_A=25^\circ C$, $V_{D1}=V_{D2}=V_{D3}=V_{D4}=3.4V$, unless otherwise specified.)

Parameter	Symbol	Conditions	Min	Typ	Max	Unit
Input Section						
Input Voltage	V_{IN}	$I_D=0$ to 40 mA	2.7		5.5	V
Supply Current	I_{CC}	No Load, ISET floating		1.5	2.5	mA
Shutdown Supply Current	I_{SHDN}	$V_{EN}=GND$		0.1	1	μA
Charge Pump Section						
Switching Frequency	f_{OSC}		0.65	1	1.35	MHz
Efficiency	η	$V_{IN}=3.5V$, $I_D=40mA$ Total		93		%
Current Source Section						
Maximum Output Current per Source	I_{DX}	$3.2V \leq V_{IN} \leq 5.5V$, $T_A=-40^\circ C$ to $85^\circ C$	18	20	22	mA
Current Matching between Any Two Outputs	$I_{D-MATCH}$		-3		3	%
Output Current Line Regulation	$(\Delta I_D/I_D)/\Delta V$	$3.5V \leq V_{IN} \leq 5.5V$	-2		2	%/V
Current Matching between Any Two Outputs under Different LED Forward Voltage	$\Delta I_D/I_D$	$3.0V \leq V_D \leq 4.0V$, $V_{IN}=3.5V$	-5		5	%
Reference Voltage for Current Set	V_{ISET}		1.193	1.23	1.267	V
I_D to I_{SET} Current Ratio	K		100	120	140	
Enable Section						
EN High Level Threshold Voltage	V_{IH}		1.4			V
EN Low Level Threshold Voltage	V_{IL}				0.5	V
EN Input Leakage Current	I_{EN}	$V_{EN}=5.5V$	-1		1	μA
EN Low Threshold Time for Standby State	t_{STB}			2		ms
Total Device						
Soft-Start Time	t_{SS}	$I_D=80mA$ Total		400		μs
Thermal Shutdown	T_{OTSD}			160		$^\circ C$
Thermal Shutdown Hysteresis	T_{HYS}			20		$^\circ C$



4-Channel Charge Pump LED Driver with Current Balancing and Wide Range PWM Dimming AP3605

Typical Performance Characteristics

($V_{IN}=3.5V$, $V_{EN}=V_{IN}$, $R_{ISET}=1.8k\Omega$, $C_{FLY1}=C_{FLY2}=C_{IN}=C_{OUT}=1\mu F$, $T_A=25^\circ C$, $V_{D1}=V_{D2}=V_{D3}=V_{D4}=3.4V$, unless otherwise specified. V_{OUT} is the output voltage when V_{OUT1} and V_{OUT2} are connected.)

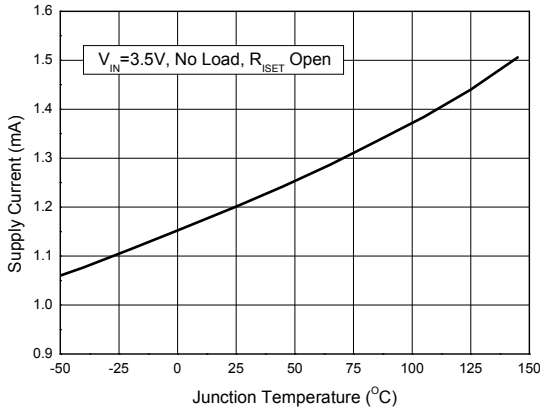

Figure 4. Supply Current vs. Junction Temperature

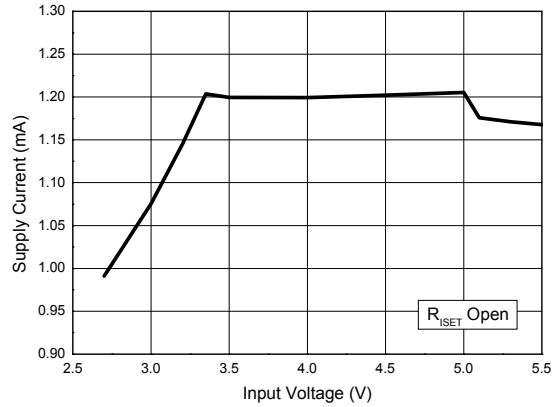

Figure 5. Supply Current vs. Input Voltage

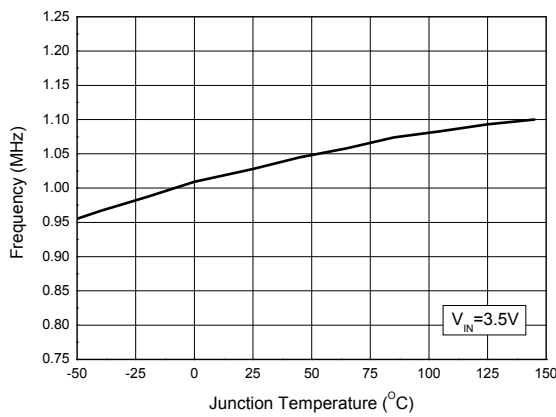

Figure 6. Frequency vs. Junction Temperature

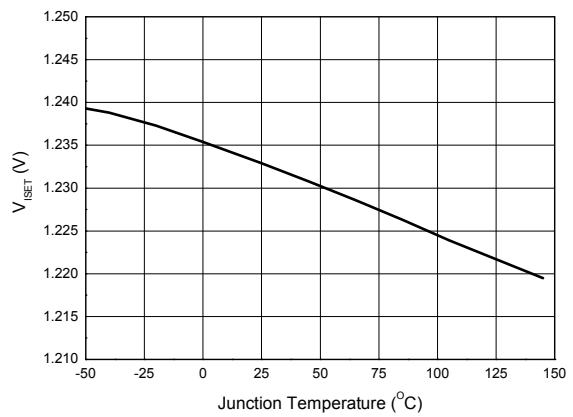

Figure 7. Reference Voltage vs. Junction Temperature



4-Channel Charge Pump LED Driver with Current Balancing and Wide Range PWM Dimming AP3605

Typical Performance Characteristics (Continued)

($V_{IN}=3.5V$, $V_{EN}=V_{IN}$, $R_{ISET}=1.8k\Omega$, $C_{FLY1}=C_{FLY2}=C_{IN}=C_{OUT}=1\mu F$, $T_A=25^\circ C$, $V_{D1}=V_{D2}=V_{D3}=V_{D4}=3.4V$, unless otherwise specified. V_{OUT} is the output voltage when V_{OUT1} and V_{OUT2} are connected.)

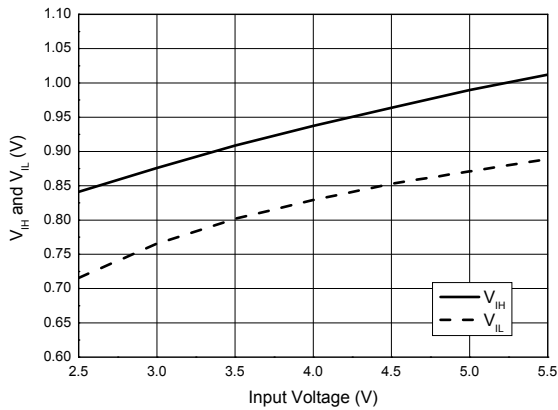

Figure 8. V_{IH} and V_{IL} vs. Input Voltage

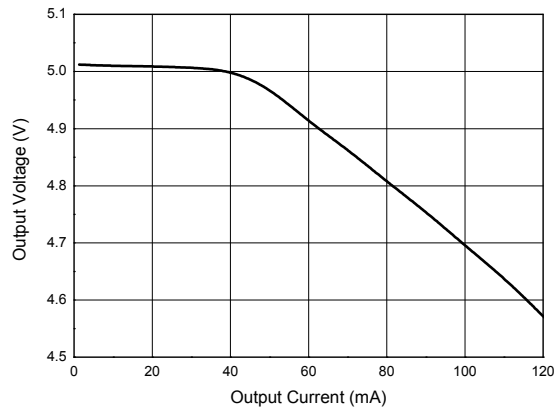

Figure 9. Output Voltage vs. Output Current

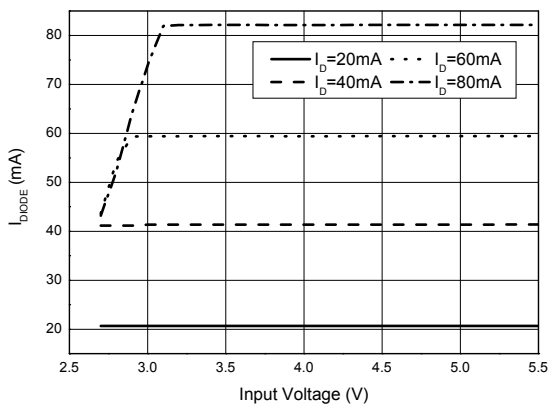

Figure 10. I_{DIODE} vs. Input Voltage

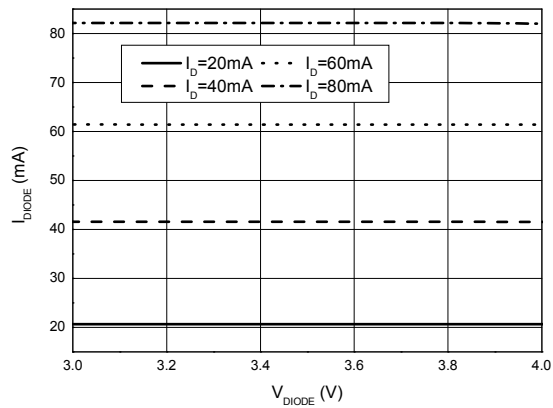

Figure 11. I_{DIODE} vs. V_{DIODE}



4-Channel Charge Pump LED Driver with Current Balancing and Wide Range PWM Dimming AP3605

Typical Performance Characteristics (Continued)

($V_{IN}=3.5V$, $V_{EN}=V_{IN}$, $R_{ISET}=1.8k\Omega$, $C_{FLY1}=C_{FLY2}=C_{IN}=C_{OUT}=1\mu F$, $T_A=25^\circ C$, $V_{D1}=V_{D2}=V_{D3}=V_{D4}=3.4V$, unless otherwise specified. V_{OUT} is the output voltage when V_{OUT1} and V_{OUT2} are connected.)

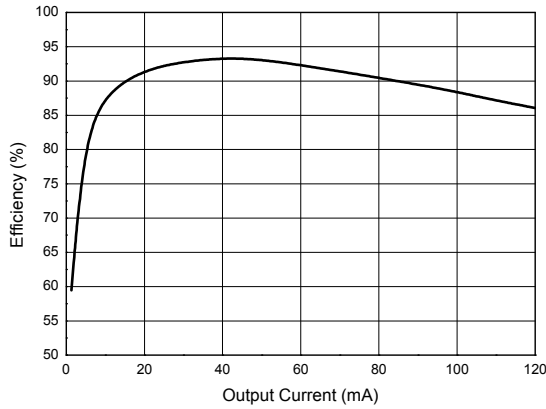

Figure 12. Efficiency vs. Output Current

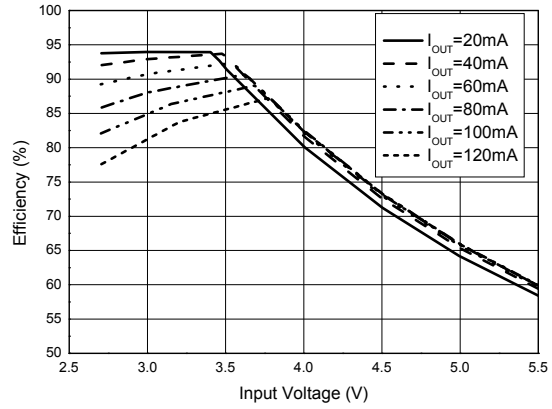

Figure 13. Efficiency vs. Input Voltage

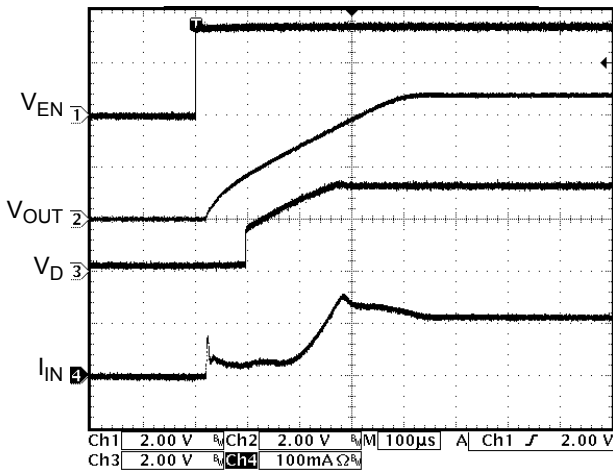

Figure 14. Turn on Characteristic

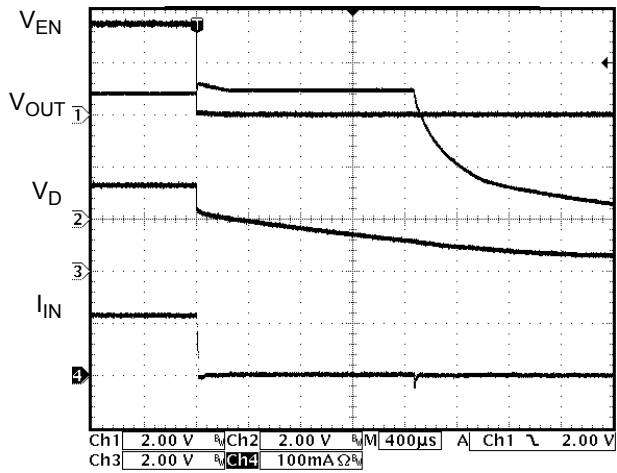

Figure 15. Turn off Characteristic



4-Channel Charge Pump LED Driver with Current Balancing and Wide Range PWM Dimming AP3605

Typical Performance Characteristics (Continued)

($V_{IN}=3.5V$, $V_{EN}=V_{IN}$, $R_{ISET}=1.8k\Omega$, $C_{FLY1}=C_{FLY2}=C_{IN}=C_{OUT}=1\mu F$, $T_A=25^\circ C$, $V_{D1}=V_{D2}=V_{D3}=V_{D4}=3.4V$, unless otherwise specified. V_{OUT} is the output voltage when V_{OUT1} and V_{OUT2} are connected.)

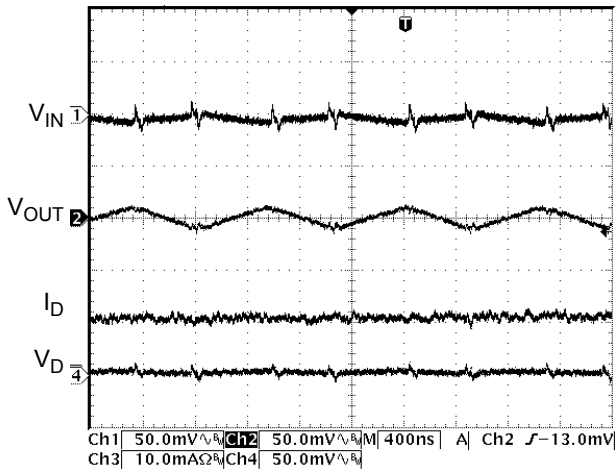

Figure 16. Output Ripple @ $I_D=40mA$

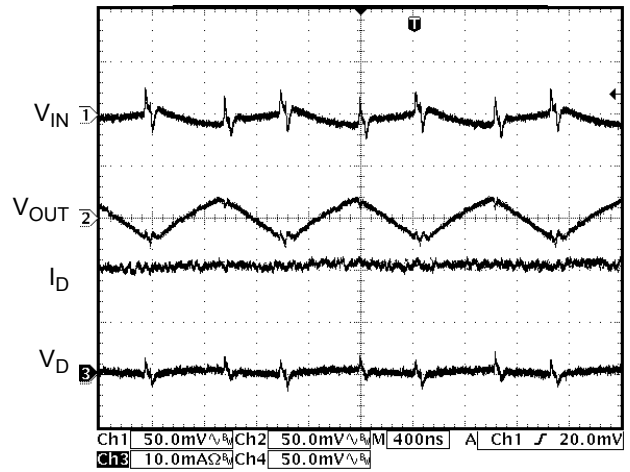

Figure 17. Output Ripple @ $I_D=80mA$

4-Channel Charge Pump LED Driver with Current Balancing and Wide Range PWM Dimming AP3605

Operation

The AP3605 is a high efficiency 1.5x fractional charge pump with 4 channels of integrated current source for white LED backlight applications. The AP3605 consists of a linear regulator followed by a 1.5x charge pump which operates at 1MHz, 4 channels current source, a reference and other control circuits. The linear regulator regulates its output voltage to supply charge pump, guarantees that the charge pump always operates at 5V output with 1.5x mode. This configuration minimizes the output ripple.

up to 20mA of current. The maximum LED current is set by a resistor connected to the ISET pin which programs a reference current, then the reference current is mirrored to set the LED current.

Applying a PWM signal to the EN pin can be used to achieve LED brightness dimming. Integrated 2ms standby function helps to enhance the dimming control. Detailed descriptions please see the related application note.

The charge pump can generate 80mA of output current, so each of the 4 WLED can be powered with

Typical Application

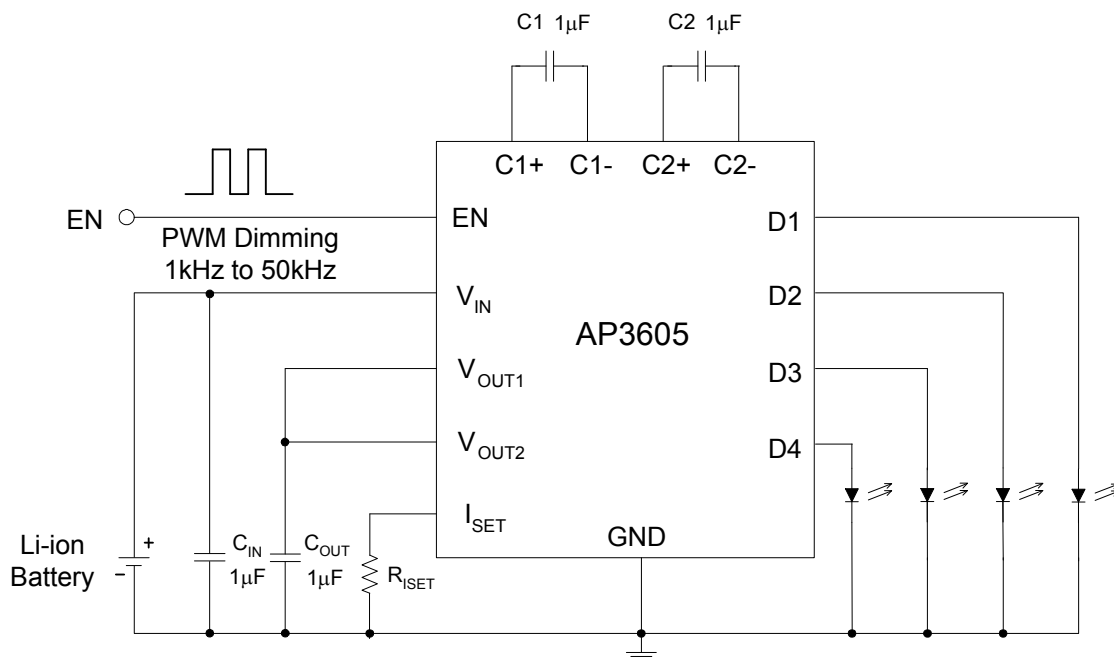

Figure 18. AP3605 Typical Application Circuit with 4 WLEDs

4-Channel Charge Pump LED Driver with Current Balancing and Wide Range PWM Dimming AP3605

Typical Application (Continued)

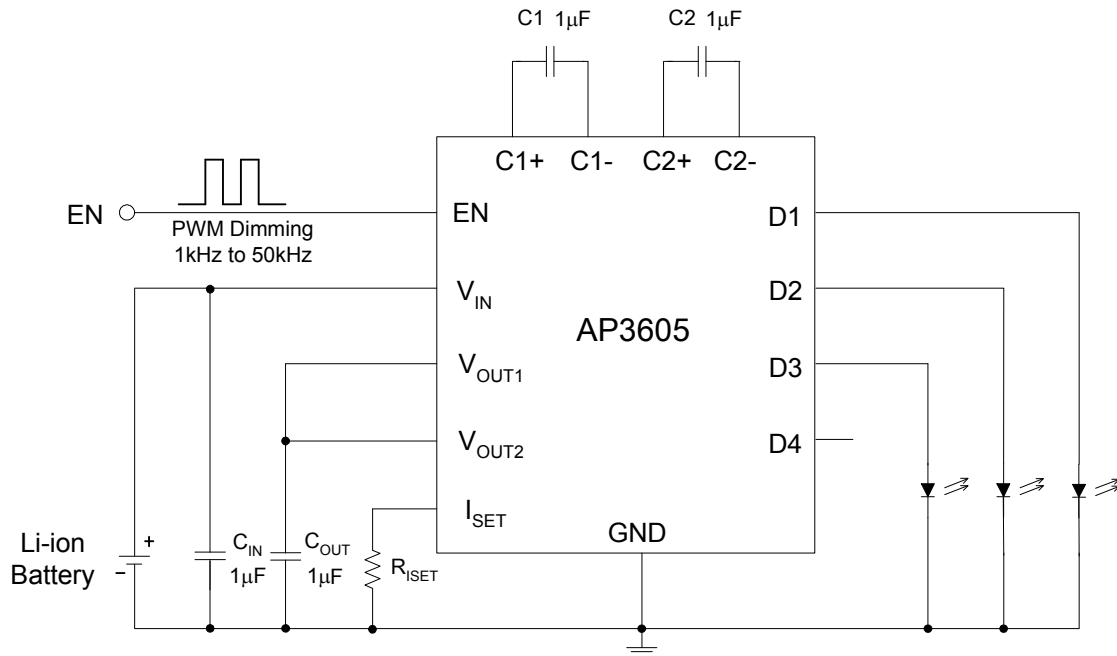

Figure 19. AP3605 Typical Application Circuit with 3 WLEDs



4-Channel Charge Pump LED Driver with Current Balancing and Wide Range PWM Dimming AP3605

Mechanical Dimensions

QFN-3x3-16

Unit: mm(inch)

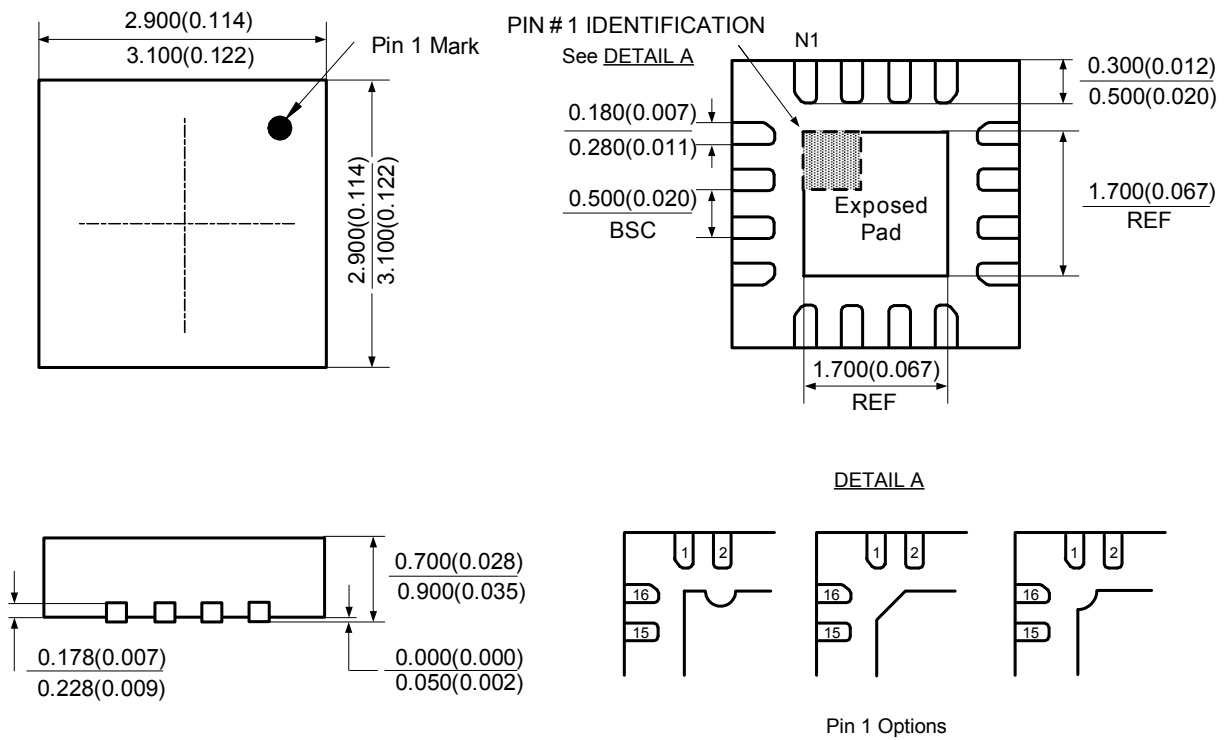



BCD Semiconductor Manufacturing Limited

<http://www.bcdsemi.com>

IMPORTANT NOTICE

BCD Semiconductor Manufacturing Limited reserves the right to make changes without further notice to any products or specifications herein. BCD Semiconductor Manufacturing Limited does not assume any responsibility for use of any its products for any particular purpose, nor does BCD Semiconductor Manufacturing Limited assume any liability arising out of the application or use of any its products or circuits. BCD Semiconductor Manufacturing Limited does not convey any license under its patent rights or other rights nor the rights of others.

MAIN SITE

- Headquarters

BCD Semiconductor Manufacturing Limited

No. 1600, Zi Xing Road, Shanghai Zizhu Science-based Industrial Park, 200241, China
Tel: +86-21-24162266, Fax: +86-21-24162277

- Wafer Fab

Shanghai SIM-BCD Semiconductor Manufacturing Co., Ltd.

800 Yi Shan Road, Shanghai 200233, China
Tel: +86-21-6485 1491, Fax: +86-21-5450 0008

REGIONAL SALES OFFICE

Shenzhen Office

Shanghai SIM-BCD Semiconductor Manufacturing Co., Ltd., Shenzhen Office

Unit A Room 1203, Skyworth Bldg., Gaoxin Ave. 1.S., Nanshan District, Shenzhen, China
Tel: +86-755-8826 7951
Fax: +86-755-8826 7865

Taiwan Office

BCD Semiconductor (Taiwan) Company Limited

4F, 298-1, Rui Guang Road, Nei-Hu District, Taipei, Taiwan
Tel: +886-2-2656 2808
Fax: +886-2-2656 2806

USA Office

BCD Semiconductor Corp.

30920 Huntwood Ave. Hayward, CA 94544, USA
Tel : +1-510-324-2988
Fax: +1-510-324-2788